

Central Office Tools for Verizon

Provided By:



The "Cord Company" and more . . .

For a Complete
Material ID List & Catalog visit:
www.tagcords.com
or email:
custsvcs@tagcords.com

REPLACEMENT TERMINALS



SOLID STATE SCSI DRIVES

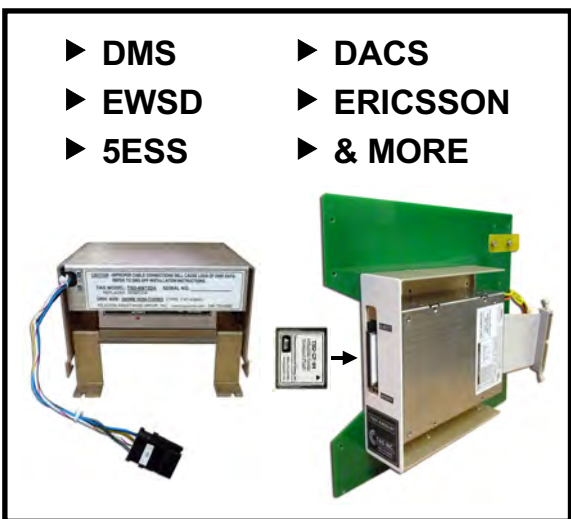

- **NEW Replacement Terminals** (DMS, 5ESS, Titan 5500 & More)
- **NEW Solid State SCSI Drives** (DMS, 5ESS, EWSD, DACS & More)
- **Coax Patch Cords**
- **"Froggers"**
- **Multi-Cords** (Quick Disconnect)
- **Portable HDSL "Smart Jacks"** (4 Slots for 2W & 4W Cards)
- **Fiber Optic Cord Kit** (Test cords & Adapters)

856-753-8585

DMS Terminal Replacements - Dual Session

Model:

TT-DCAP-DMSKIT

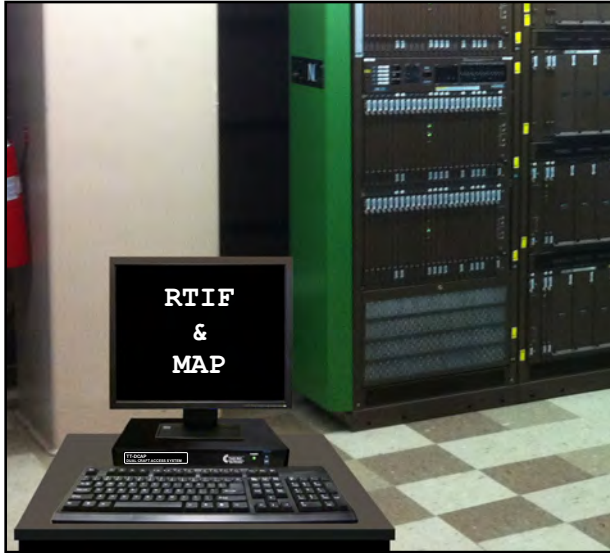

Kit Includes (TT-DCAP-DMSKIT):

- (1) 17" Flat Screen Monitor
- (1) Dumb Terminal Controller
- (1) Keyboard
- (1) Quick Guide
- (2) 400700,
(DB25F Gender Changer) 
- (2) 400725SB2,
(DMS Quick Connect Current Loop Adapter Cable w/ DEC Connector)



SPECIFICATIONS

- VT-100 COMPATIBLE
- DUAL RS-232 INPUTS
- PRINTER OUTPUT
- LOW POWER

Printer Port Type:



Parallel * ** If a Serial Port is needed, please order a Parallel to Serial Adapter # TT-PSA, VZ ID # 1118 2239.*

Ordering Information:

TT-DCAP-DMSKIT

Dual Craft Access System - DMS (Kit 1)

includes: (1) 17" Flat Screen Monitor, (1) Keyboard,
(1) Dual Session Dumb Terminal Controller, (1) Quick Guide,
(2) # 400700 (DB25F Gender Changer) &
(2) # 400725SB2 (DMS Quick Connect Current Loop Adapter Cable w/ DEC Connector)

**KIT VZ ID #
1133 0726**

TT-DCAP-DMSKIT2

Dual Craft Access System - DMS (Kit 2)

includes: (1) 17" Flat Screen Monitor, (1) Keyboard,
(1) Dual Session Dumb Terminal Controller, (1) Quick Guide,
(2) # 400700 (DB25F Gender Changer),
(2) # 400725SB2 (DMS Quick Connect Current Loop Adapter Cable w/ DEC Connector) &
(2) # 400725SBW** (Hardwire Adapter for 400725SB2) **not shown

**KIT VZ ID #
1133 0728**

TT-DCAP

Dual Craft Access System - DMS

includes: (1) 17" Flat Screen Monitor, (1) Keyboard,
(1) Dual Session Dumb Terminal Controller, (1) Quick Guide &
(2) # 400700 (DB25F Gender Changer)

**VZ ID #
1133 0727**

TT-DCA5-PP

Replacement Power Pack for DMS Terminal, 5VDC (not shown) 1136 2015

150 Cooper Rd. (F-15)
W. Berlin, NJ 08091

www.tagcords.com

Telephone: (856) 753-8585

Fax : (856) 768-7645

Telecom Assistance Group

5ESS MCC Terminal w/ "Glass Printer" Feature

NEW "Glass Printer" Feature allows Capture of ROP & Scroll Reports

Benefits:

- CAPTURE SCROLLING REGION & ROP INFORMATION WITHOUT PAPER
- ELIMINATE OLD TERMINALS, READ ONLY PRINTERS & PAPER WASTE

OLD



~~ROP PRINTER~~

NEW

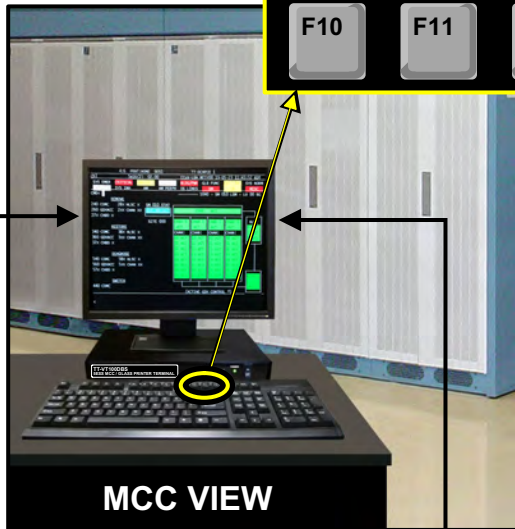

MCC VIEW

(KEYBOARD FUNCTION TIPS)

SCRL ROP	PRTR ON/OFF	MCC GP
F10	F11	F12

GP = GLASS PRINTER

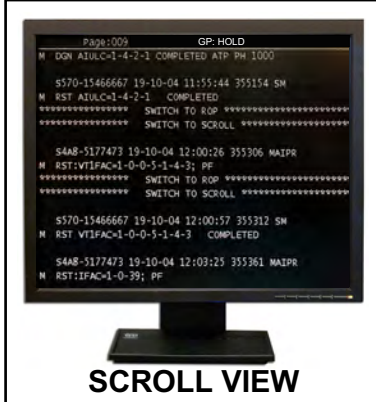

SCROLL VIEW

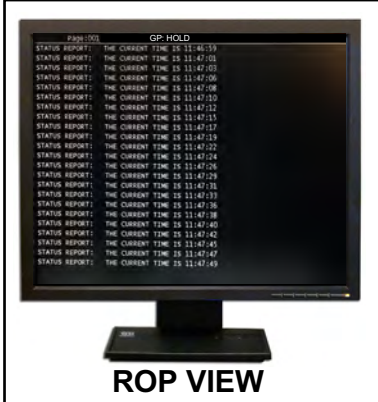

ROP VIEW

Ordering Information:

TT-VT100DBS 5ESS MCC Terminal w/ "Glass Printer" Feature

includes: (1) 17" Flat Screen Monitor, (1) Keyboard,
 (1) MCC Terminal Controller w/ Glass Printer (Capture Scroll & ROP),
 (2) # 400701, DB25M Gender Changers & (1) Quick Guide

VZ ID #
1137 2216

150 Cooper Rd. (F-15)
 W. Berlin, NJ 08091

www.tagcords.com

Telephone: (856) 753-8585
 Fax : (856) 768-7645

Telecom Assistance Group

New Replacement Dumb Terminals - Transport / DACS Equipment

NEW TERMINAL WORKS ON
Titan 5500, CS1, CS1L, DACS II, III, IV, Alcatel 1631 & HDSL
(Titan 5500 shown below)

REMOVE & REPLACE OLD / BROKEN CRTs



SPECIFICATIONS

- VT-100 COMPATIBLE
- RS-232 INPUT(S)
- PRINTER OUTPUT
- LOW POWER

Ordering Information:

		<u>VZ ID #</u>
TT-VT100S	Single Session Dumb Terminal - Transport includes: (1) 17" Flat Screen Monitor, (1) Keyboard, (1) Single Session Terminal Controller, (1) DB25M Gender Changer & (1) Quick Guide	1131 9854
TT-SCA1631	Single Session Dumb Terminal - 1631 DACS includes: (1) 17" Flat Screen Monitor, (1) Keyboard w/ 1631 labels, (1) Pre-configured 1631 Single Session Terminal Controller, (1) DB25M Gender Changer & (1) 1631 Quick Guide	1136 2874
TT-DCT55	Dual Session Dumb Terminal - Titan 5500 includes: (1) 17" Flat Screen Monitor, (1) Keyboard, (1) Pre-configured Titan 5500 Dual Session Terminal Controller, (2) DB25F Gender Changers & (1) Titan 5500 Quick Guide	1131 5065

150 Cooper Rd. (F-15)
 W. Berlin, NJ 08091

www.tagcords.com

Telephone: (856) 753-8585
 Fax : (856) 768-7645

Telecom Assistance Group

Verizon Approved - NEBS Certified - DPP Disk Drive Solutions from TAG

**NORTEL DMS-100 SWITCH
w/ EXISTING DPP DRIVES (w/ "MOVING PARTS")**



**NEW REPLACEMENT
SOLID STATE
SCSI DRIVE MODULE
FROM TAG**

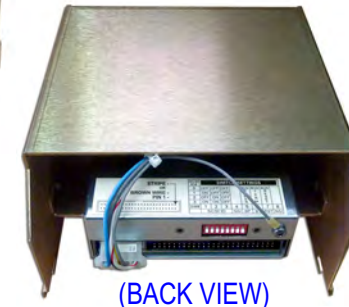

(BACK VIEW)

NEW DPP AMA DISK DRIVES AVAILABLE FROM TAG

TAG MODEL #	Replaces PN / HECI			
TSD-6M72BA	NT6M72BA / ENPQBB61XX	140 mb	non turbo	CLEI: 9937433 *
TSD-6M72DA	NT6M72DA	380 mb	non turbo	CLEI: 9937501 *
TSD-6M72DD	NT6M72DD	380 mb	turbo	VZ ID# 1132 2154
TSD-6M72EA	NT6M72EA / ENPQ72EAAA	760 mb	turbo	CLEI: 9937767 *
TSD-6M72GA	NT6M72GA / AMPQADFJAA NT6M72JA / AMPQAECJAA	1 gb	turbo	CLEI: 9937588 *
TSD-6M72HA	NT6M72HA / AMPQADGJAA NT6M72KA / AMPQAEBJAA	2 gb	turbo	VZ ID# 1132 5748

*** Contact Verizon CST / PICS to order CLEIs: 888-225-7427**

Application:

TAG can **REPLACE** failing / broken Nortel DMS-100/10 switch Distributed Processing Peripheral (DPP) and Billing Media Converter (BMC) Disk Drives. These systems allow for remote polling of Automatic Message Accounting (AMA) data from the Nortel DMS-100/10 switch to central billing collector sites.

150 Cooper Rd. (F-15)
W. Berlin, NJ 08091

www.tagcords.com

Telecom Assistance Group

Telephone: (856) 753-8585

Fax : (856) 768-7645

Verizon Approved - NEBS Certified - Siemens EWSD Drive Solutions from TAG

SIEMENS EWSD w/ EXISTING DRIVES MAGNETO-OPTICAL (MO) & HARD DISK (HDD) (w/ "MOVING PARTS")

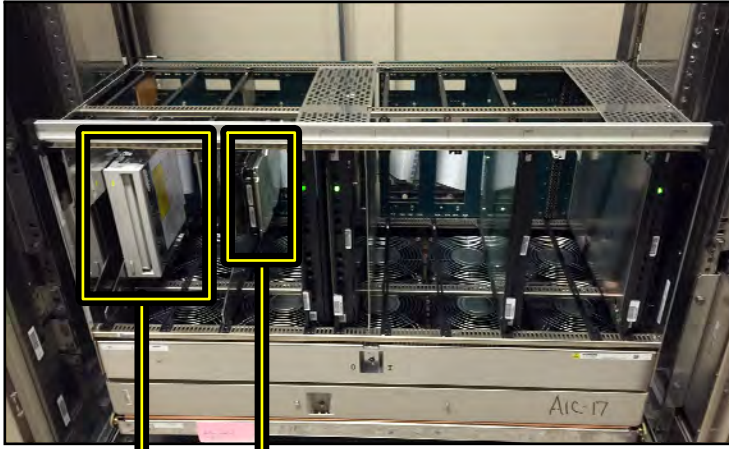

HARD DISK (HDD)

MAGNETO-OPTICAL (MO)

Application:

TAG can **REPLACE** failing / broken Siemens EWSD Magneto-Optical (MO) & Hard Disk (HDD) Drives with **NEW** Solid State Drives.

NEW SOLID STATE DRIVES FROM TAG

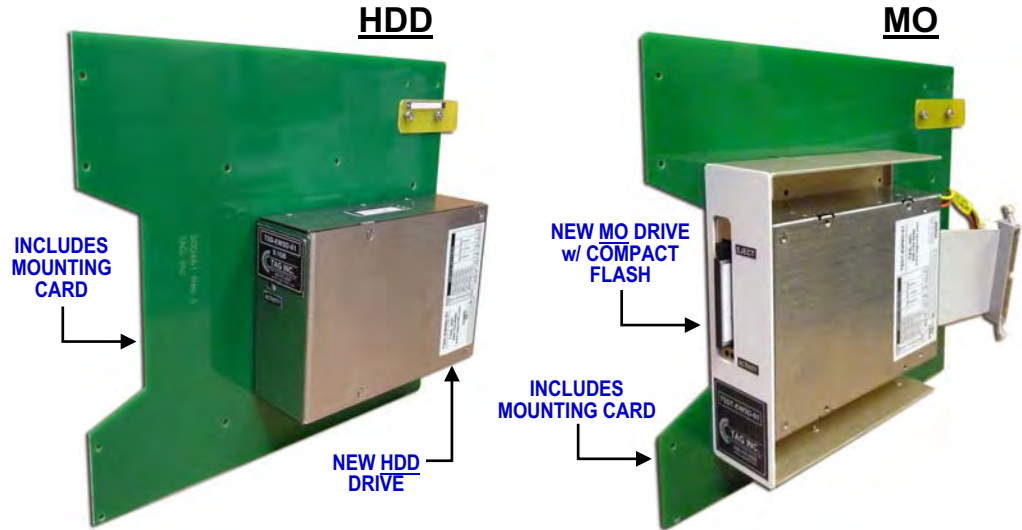

Contact Verizon CST / PICS to order: **888-225-7427**

TAG MODEL #	USED IN SIEMENS EWSD HDD MODULE (HECI EQMYAE0DAA)	
TSD-EWSD-01	Solid State Replacement for: Siemens EWSD Module # S30807-U2594-X300 (HECI EQMYAE0DAA) Hard Disk Drive (HDD) w/ Mounting (S30122-U789-X-2 (ST-39173N))	9.1Gb
VZ CLEI 9933201		
TAG MODEL #	USED IN SIEMENS EWSD MO DRIVE MODULE (HECI EGM8JF0BRA)	
TSDT-EWSD-01	Solid State Replacement for: Siemens EWSD Module # S30807-U2593-X200 (HECI EGM8JF0BRA) Magneto-Optical (MO) Drive w/ Mounting (S30122-U563-X400) <i>Includes: 4Gb Industrial Compact Flash Card (PN# TSD-CF-04*)</i>	4Gb
VZ CLEI 9937460		
* Additional Compact Flash Cards are Available: 4Gb (# TSD-CF-04, VZ CLEI # 9937459), 8Gb (# TSD-CF-08, VZ ID # 7501 1503) & 16Gb (# TSD-CF-16)		

150 Cooper Rd. (F-15)
W. Berlin, NJ 08091

www.tagcords.com

Telecom Assistance Group

Telephone: (856) 753-8585

Fax: (856) 768-7645

NEBS Certified - DMS-10 (NT4T32BA) Disk Drive Solution from TAG

**NORTEL DMS-10 NT4T32BA MODULE
w/ Magneto-Optical (MO) Drive (w/ "MOVING PARTS")**

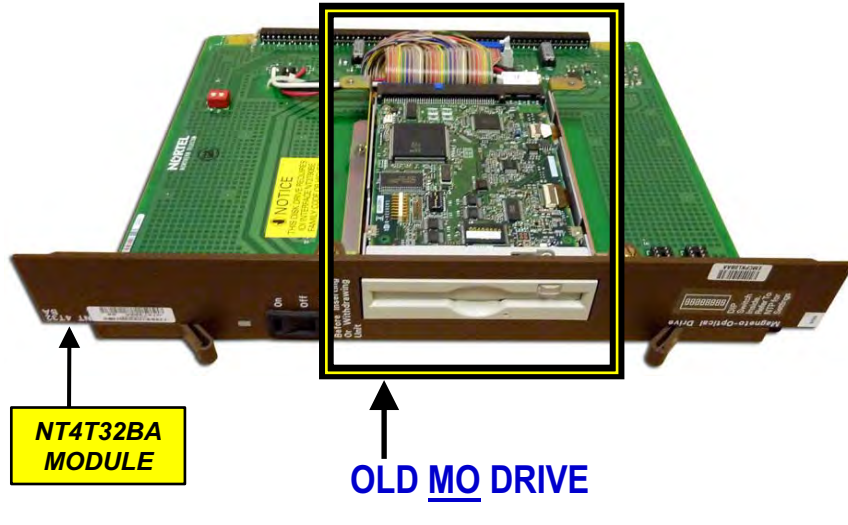

NEW SOLID STATE DRIVE FROM TAG

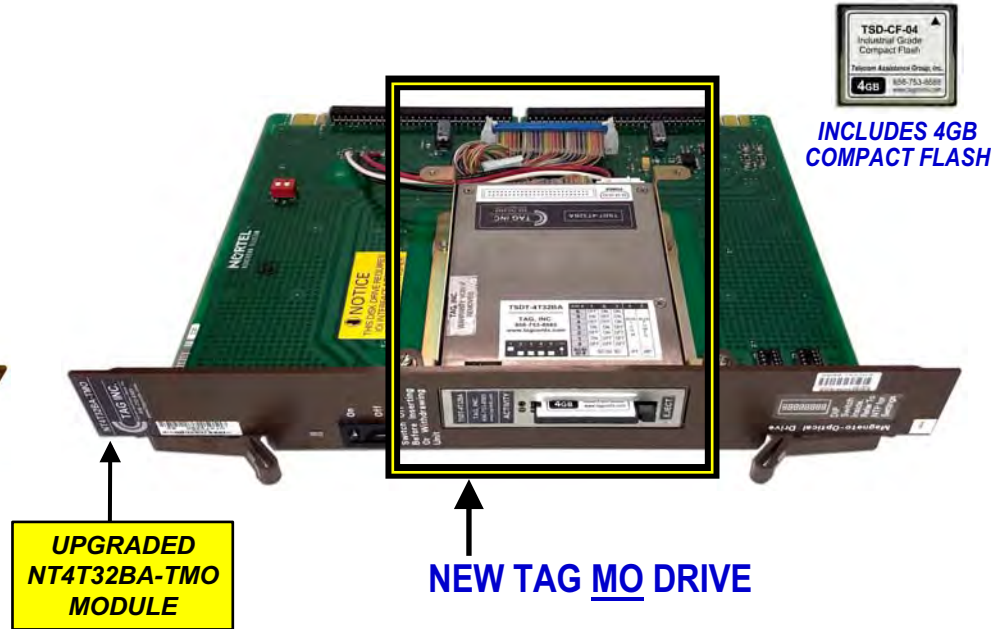

Application:

TAG can **REPLACE** the failing / broken Nortel DMS-10 Magneto-Optical (MO) Drive in the NT4T32BA Module with a **NEW** Solid State Drive.

(TAG installs a new Solid State Drive on your NT4T32BA module & returns it to VZ PICS)

Contact Verizon CST / PICS to order: 888-225-7427

TAG MODEL #	NT4T32BA MODULE (HECI EMCPKL0BAA)
NT4T32BA-TMO	Solid State Replacement for: Nortel DMS-10 (HECI EMCPKL0BAA) NT4T32BA (Fujitsu MCF3064 SS) Magneto-Optical (MO) Drive, Includes: 4Gb Industrial Compact Flash Card (PN # TSD-CF-04*)
VZ CLEI 9933014	
* Additional Compact Flash Cards are Available: 4Gb (# TSD-CF-04, VZ CLEI # 9937459), 8Gb (# TSD-CF-08, VZ ID # 7501 1503) & 16Gb (# TSD-CF-16)	

150 Cooper Rd. (F-15)
W. Berlin, NJ 08091

www.tagcords.com
Telecom Assistance Group

Telephone: (856) 753-8585
Fax : (856) 768-7645

COAX PATCH CORDS

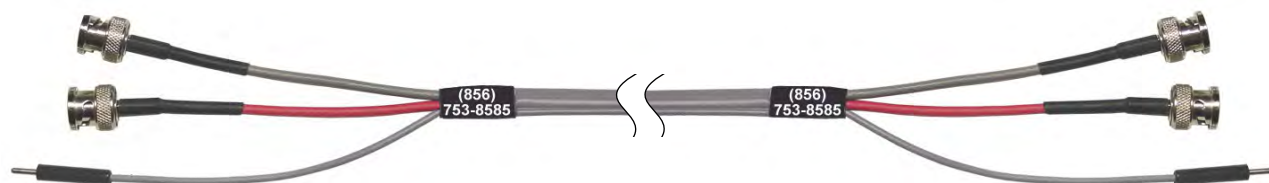

Ordering Information:

		VZ ID #
400440BB-01	Dual BNC to Dual BNC w/ tracer, (1')	1100 7839
400440BB-03	Dual BNC to Dual BNC w/ tracer, (3')	1100 7840
400440BB-05	Dual BNC to Dual BNC w/ tracer, (5')	1100 7841
400440BB-07	Dual BNC to Dual BNC w/ tracer, (7')	1100 7842
400440BB-09	Dual BNC to Dual BNC w/ tracer, (9')	1100 7843
400440BB-10	Dual BNC to Dual BNC w/ tracer, (10')	8721 0460
400440BB-11	Dual BNC to Dual BNC w/ tracer, (11')	1105 4902
400440BB-15	Dual BNC to Dual BNC w/ tracer, (15')	914370
400440BB-19	Dual BNC to Dual BNC w/ tracer, (19')	914374
400440BB-20	Dual BNC to Dual BNC w/ tracer, (20')	1108 9990
400440BB-25	Dual BNC to Dual BNC w/ tracer, (25')	8725 9527
400440BB-30	Dual BNC to Dual BNC w/ tracer, (30')	8728 1688
400440BB-35	Dual BNC to Dual BNC w/ tracer, (35')	1100 7846
400440BB-37	Dual BNC to Dual BNC w/ tracer, (37')	914393
400440BB-40	Dual BNC to Dual BNC w/ tracer, (40')	8721 0473
400440BB-45	Dual BNC to Dual BNC w/ tracer, (45')	1100 7848

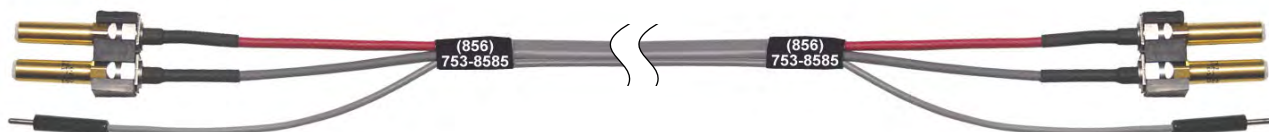

Ordering Information:

		VZ ID #
400440DD-01	Dual 440D to Dual 440D w/ tracer, (1')	8727 0227
400440DD-03	Dual 440D to Dual 440D w/ tracer, (3')	8725 8439
400440DD-05	Dual 440D to Dual 440D w/ tracer, (5')	1100 7852
400440DD-07	Dual 440D to Dual 440D w/ tracer, (7')	8725 6800
400440DD-09	Dual 440D to Dual 440D w/ tracer, (9')	5700 8378
400440DD-10	Dual 440D to Dual 440D w/ tracer, (10')	1108 9987
400440DD-15	Dual 440D to Dual 440D w/ tracer, (15')	8721 8524
400440DD-20	Dual 440D to Dual 440D w/ tracer, (20')	1108 9988
400440DD-25	Dual 440D to Dual 440D w/ tracer, (25')	8721 8527
400440DD-30	Dual 440D to Dual 440D w/ tracer, (30')	1108 9989
400440DD-35	Dual 440D to Dual 440D w/ tracer, (35')	1100 7857
400440DD-40	Dual 440D to Dual 440D w/ tracer, (40')	8726 0897
400440DD-45	Dual 440D to Dual 440D w/ tracer, (45')	1100 7859
400440DD-50	Dual 440D to Dual 440D w/ tracer, (50')	8725 4584



150 Cooper Rd. (F-15)
W. Berlin, NJ 08091

www.tagcords.com

Telephone: (856) 753-8585
Fax : (856) 768-7645

Telecom Assistance Group

Verizon

FEATURES / APPLICATION	PART #	VZ ID #	DESCRIPTION
Dual Bantam to Dual Bantam, (6')	400210DD	8702 8141	DUAL BANTAM to DUAL BANTAM 
Dual Bantam to Dual Bantam, (2')	400210DD-02	8725 6802	
Dual Bantam to Dual Bantam, (10')	400210DD-10	8725 6615	
Dual Bantam to Dual Bantam, (12')	400210DD-12	364581	
Dual Bantam to Dual Bantam, (15')	400210DD-15	1136 1856	
Dual Bantam to Dual Bantam, (20')	400210DD-20	8723 8449	
Dual Bantam to Dual Bantam, (25')	400210DD-25	8727 5015	
Dual Bantam to Dual Bantam, (30')	400210DD-30	8722 5337	
Dual Bantam to Dual Bantam, (40')	400210DD-40	8725 0208	
Dual Bantam to Dual Bantam, (50')	400210DD-50	8728 6622	
Dual Bantam to Dual Bantam, (75')	400210DD-75	8728 4587	
<ul style="list-style-type: none"> • General purpose test / patch cord 			
Bantam to Bantam, (6')	400210	8721 4240	BANTAM to BANTAM 
Bantam to Bantam, (2')	400210-02	8727 2187	
Bantam to Bantam, (4')	400210-04	8727 3292	
Bantam to Bantam, (10')	400210-10	8725 7313	
Bantam to Bantam, (12')	400210-12	8724 0825	
Bantam to Bantam, (15')	400210-15	8727 3294	
Bantam to Bantam, (20')	400210-20	8723 6197	
Bantam to Bantam, (25')	400210-25	8727 4263	
Bantam to Bantam, (30')	400210-30	8722 2495	
Bantam to Bantam, (40')	400210-40	8726 0958	
Bantam to Bantam, (50')	400210-50	1105 1326	
<ul style="list-style-type: none"> • General purpose test / patch cord 			

"Frogger" Protector Test Cord, (20')

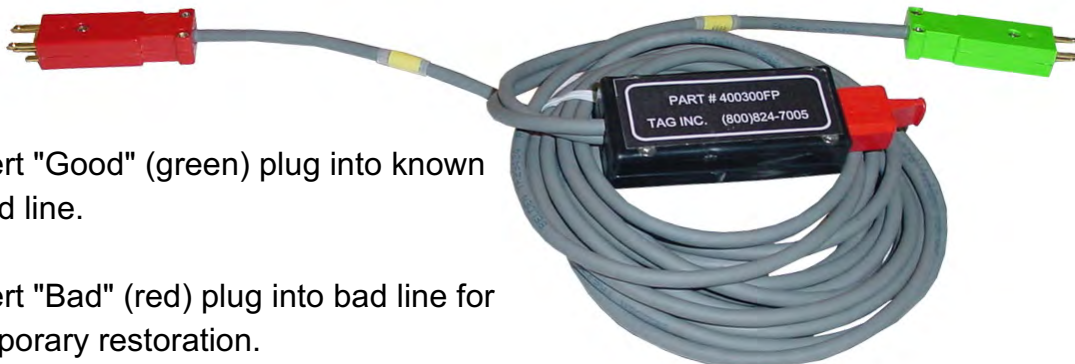

1. Insert "Good" (green) plug into known good line.
2. Insert "Bad" (red) plug into bad line for temporary restoration.

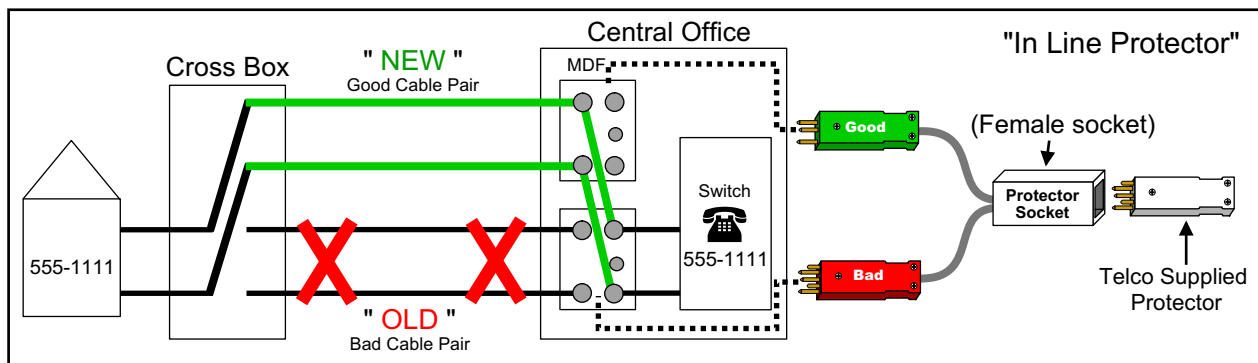

Application:

TAG's Temporary Restoral Cord (400300FP) allows you to add protection back to the telephone line when testing. TAG's test cord features a built-in protector socket that accepts any 5-pin protector module. A 5-pin module with the same specifications as the line you are testing on must be inserted before the test cord can function. Once inserted, the cord will now function and protection has been restored to the line.

In the event of a power or lightning strike, TAG's 400300FP can save thousands of dollars by eliminating dangers that can destroy expensive equipment or possibly harm a technician. One plug is Green "GOOD" & the other plug is Red "BAD". When the repair is made, the circuit can be identified as to which pair is good or bad.

Ordering Information:

		<u>VZ ID #</u>
400300FP	"Frogger" Protector Test Cord - (20')	1100 7876
400300FP-04	"Frogger" Protector Test Cord - (4')	1104 3235
400300FP-08	"Frogger" Protector Test Cord - (8')	1104 3234
400300FP-16	"Frogger" Protector Test Cord - (16')	1104 3233

150 Cooper Rd. (F-15)
W. Berlin, NJ 08091

www.tagcords.com

Telephone: (856) 753-8585
Fax : (856) 768-7645

Telecom Assistance Group



**T1/T3 Test Cord Kit for use with
VeEX MTX150-10G Test Set**

-Individual items can also be ordered-

Provides a carrying case with all the
cords that a "Tech" needs in the field

8 Pouch Carrying Case
TCC-001P

- (1) Bantam to Bantam, (8') - Red # 400210RD-08
- (1) Bantam to Bantam, (8') - Black # 400210BK-08



- (1) Bantam to Alligators, (8') - Red # 400210ARD-08
- (1) Bantam to Alligators, (8') - Black # 400210ABK-08

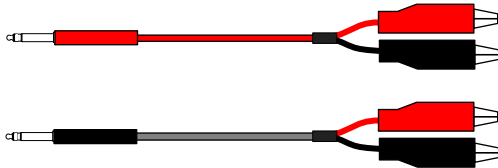

- (1) Bantam to Protector, (8') - Red # 400210SRD-08
- (1) Bantam to Protector, (8') - Black # 400210SBK-08

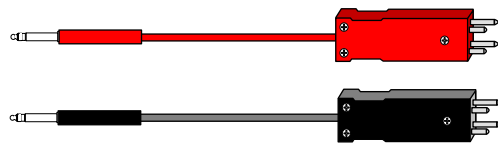

- (1) Bantam "Y" to RJ48 -T1, (8') # 400248Y



- (1) 358A to BNC, (8') - Red # 400358BRD-08
- (1) 358A to BNC, (8') - Black # 400358BBK-08

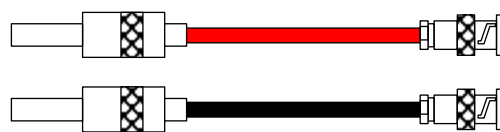

- (1) 440A to BNC (8') - Red # 400440BRD-08
- (1) 440A to BNC (8') - Black # 400440BBK-08



- (1) RJ45 to RJ45, 1Gb Ethernet Cable (10')
400445E-10

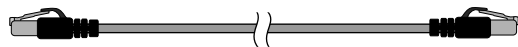

- (1) Bantam to 310 Adapter- Red # 400239RD
- (1) Bantam to 310 Adapter- Black # 400239BK

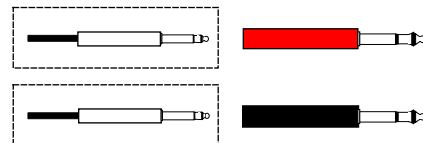

Ordering Information:

KIT-VXT1T3

T1/T3 VeEX Test Cord Kit

VZ ID #

7500 3145

150 Cooper Rd. (F-15)
W. Berlin, NJ 08091

www.tagcords.com

Telephone: (856) 753-8585
Fax : (856) 768-7645

Telecom Assistance Group

Laptop Cord Kit

KIT-LAPVZKO

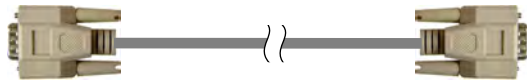

(1) # 400720MM
DB9M to DB9M, (10')
VZ ID # 1128 5350

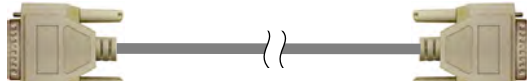

(1) # 400705
DB25M to DB25M, (6')
VZ ID # 8702 8149

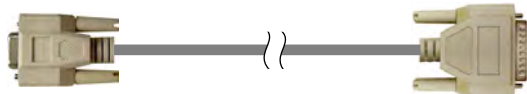

(1) # 400703
DB9F to DB25M, (6')
VZ ID # 8702 8151

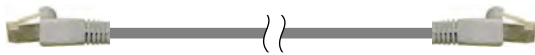

(1) # 400448-06
RJ48 to RJ48 Ethernet Cable, (6')
VZ ID # 1128 5351

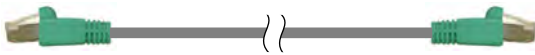

(1) # 400448XP
RJ48 to RJ48
Ethernet Crossover Cable, (10')
VZ ID # 1128 5352



(1) # 600209
Carrying Case
VZ ID # 1100 7886

Approx.
Dimensions:
5" (H) x 16" (L)



(1) # 400700
DB25F Gender Changer
VZ ID # 8722 5617



(1) # 400700N
DB25F Gender Changer (NULL)
VZ ID # 8726 2699



(1) # 400709S
DB9F Gender Changer
VZ ID # 8722 6870



(1) # 400709FN
DB9F Gender Changer (NULL)
VZ ID # 8722 6868



(1) # RJ48-C
RJ48 Coupler
VZ ID # 1128 5348



(1) # 400721USB
DB9M/RS232 to USB Adapter Cable
(includes driver software)
VZ ID # 1135 9653

Ordering Information:

KIT-LAPVZKO

Laptop Cord Kit

includes: (1) 400720MM, (1) 400705, (1) 400703, (1) 400448-06,
(1) 400448XP, (1) 400700, (1) 400700N, (1) 400709S,
(1) 400709FN, (1) RJ48-C, (1) 400721USB & (1) 600209

VZ ID # (KIT)

1128 5349

150 Cooper Rd. (F-15)
W. Berlin, NJ 08091

www.tagcords.com

Telephone: (856) 753-8585

Fax : (856) 768-7645

Telecom Assistance Group

USB-C to DB9 Pin (male) - (Android & Laptop Compatible)

400721USBC-A

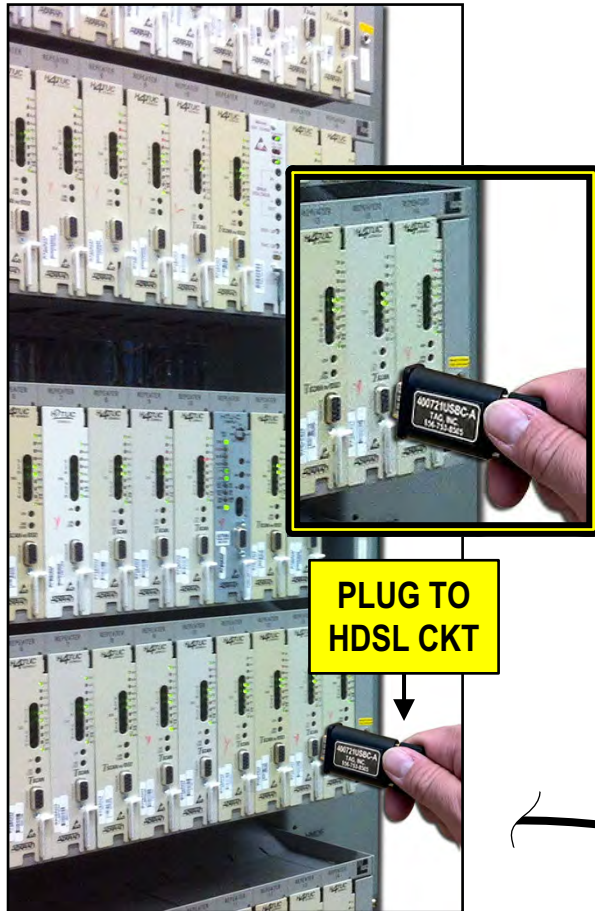

Use VZ Term Assist App to test at Pair Gain (HDSL)

PLUG TO USB-C PORT ANDROID PHONE

OR

PLUG TO USB-C PORT ON LAPTOP



Ordering Information:

400721USBC-A

USB-C to DB9 Pin (male) - (Android & Laptop Compatible), (3')

VZ ID #

7500 5061

150 Cooper Rd. (F-15)
W. Berlin, NJ 08091

www.tagcords.com

Telecom Assistance Group

Telephone: (856) 753-8585

Fax : (856) 768-7645

Simplify Network Cable Testing !!

Cable Test Features:

- Displays:**
- Short
 - Reversed
 - Miswired
 - Split Pairs

Tone Generator* Features:

- Verification of Shield Integrity
- Puts Tracer Tone on Cable

* Tone Generator function requires customer supplied Cable Tracing Probe

Additional Features:

- Specially designed Remote Unit that enables one person to test installed cables
- Easy to read Fault Display and high speed testing
- Debug mode for detailed fault identification results
- Auto Sleep Mode and Power Off Switch to decrease power consumption
- Low Battery Indicator
- Uses (4) four AAA batteries

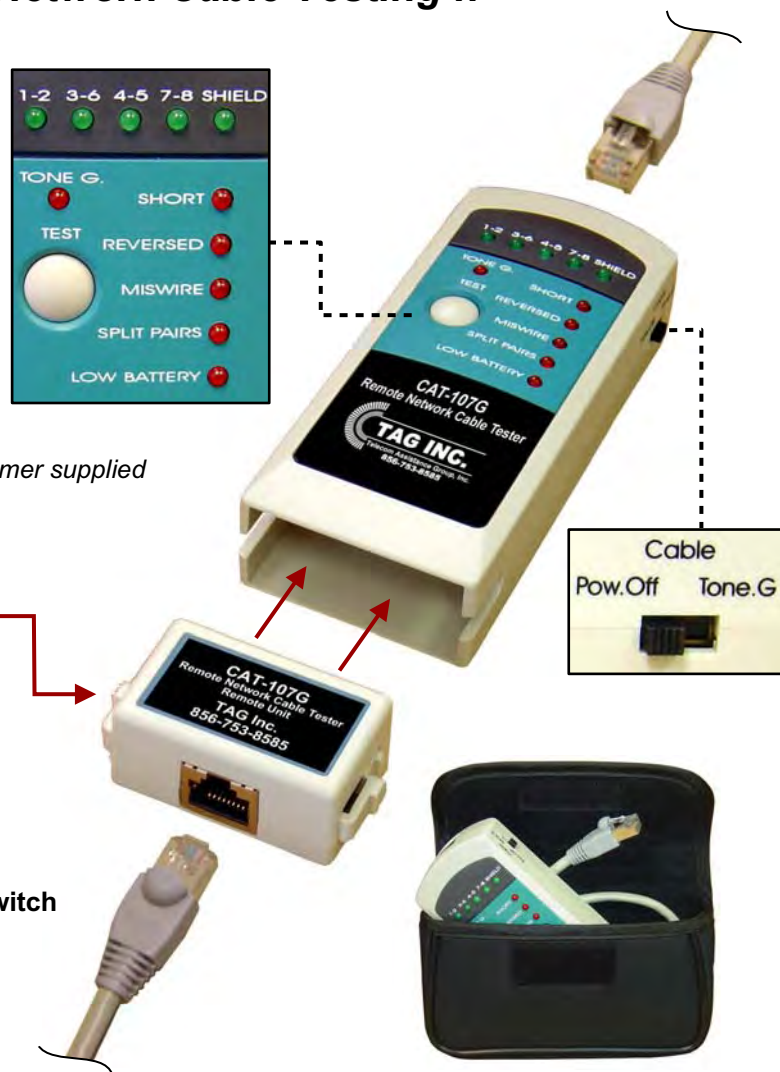

Includes: Soft Vinyl Carrying Pouch & Remote Terminating Cable

Application:

The CAT-107G is a small hand-held cable tester, which enables network professionals to quickly and easily verify the integrity of ethernet twisted pair cables for open pairs, shorted pairs, reversed pairs, crossed pairs and split pairs. Push the TEST button and the CAT-107G will automatically scan for any existing faults in your cable. The specially designed remote terminator is provided for one-person testing of installed cables. The tone generator function can be used to send a signal through installed cables which can be traced with most cable tracers on the market.

Ordering Information:

CAT-107G Remote Network Cable Tester w/ Tone Generator
includes: (1) Carrying Pouch, (1) Remote Terminating Cable & (4) AAA Batteries

VZ ID #
1132 2736

150 Cooper Rd. (F-15)
W. Berlin, NJ 08091

www.tagcords.com

Telephone: (856) 753-8585
Fax : (856) 768-7645

Telecom Assistance Group

Cat 5 Cables (RJ45 to RJ45)



CAT 5 CABLES (RJ45 to RJ45) (@ various lengths)

DESCRIPTION	PART #	VZ ID #
Cat 5 Cable (RJ45 to RJ45), (5')	RH-CAT5-05	1104 4359
Cat 5 Cable (RJ45 to RJ45), (10')	RH-CAT5-10	1104 4358
Cat 5 Cable (RJ45 to RJ45), (15')	RH-CAT5-15	1104 4357
Cat 5 Cable (RJ45 to RJ45), (20')	RH-CAT5-20	1104 4356
Cat 5 Cable (RJ45 to RJ45), (25')	RH-CAT5-25	1104 4355
Cat 5 Cable (RJ45 to RJ45), (30')	RH-CAT5-30	1104 4354
Cat 5 Cable (RJ45 to RJ45), (40')	RH-CAT5-40	1104 4353
Cat 5 Cable (RJ45 to RJ45), (45')	RH-CAT5-45	1105 7559
Cat 5 Cable (RJ45 to RJ45), (50')	RH-CAT5-50	1104 4352
Cat 5 Cable (RJ45 to RJ45), (60')	RH-CAT5-60	1105 7560
Cat 5 Cable (RJ45 to RJ45), (75')	RH-CAT5-75	1104 4351
Cat 5 Cable (RJ45 to RJ45), (80')	RH-CAT5-80	1105 7561
Cat 5 Cable (RJ45 to RJ45), (100')	RH-CAT5-100	1104 4350
Cat 5 Cable (RJ45 to RJ45), (110')	RH-CAT5-110	1105 7917
Cat 5 Cable (RJ45 to RJ45), (125')	RH-CAT5-125	1104 4349
Cat 5 Cable (RJ45 to RJ45), (150')	RH-CAT5-150	1104 4348
Cat 5 Cable (RJ45 to RJ45), (200')	RH-CAT5-200	1104 4347
Cat 5 Cable (RJ45 to RJ45), (250')	RH-CAT5-250	1104 4346
Cat 5 Cable (RJ45 to RJ45), (300')	RH-CAT5-300	1105 7557
Cat 5 Cable (RJ45 to RJ45), (350')	RH-CAT5-350	1105 7558
Cat 5 Cable (RJ45 to RJ45), (400')	RH-CAT5-400	1106 0841

150 Cooper Rd. (F-15)
W. Berlin, NJ 08091

www.tagcords.com

Telephone: (856) 753-8585
Fax : (856) 768-7645

Telecom Assistance Group

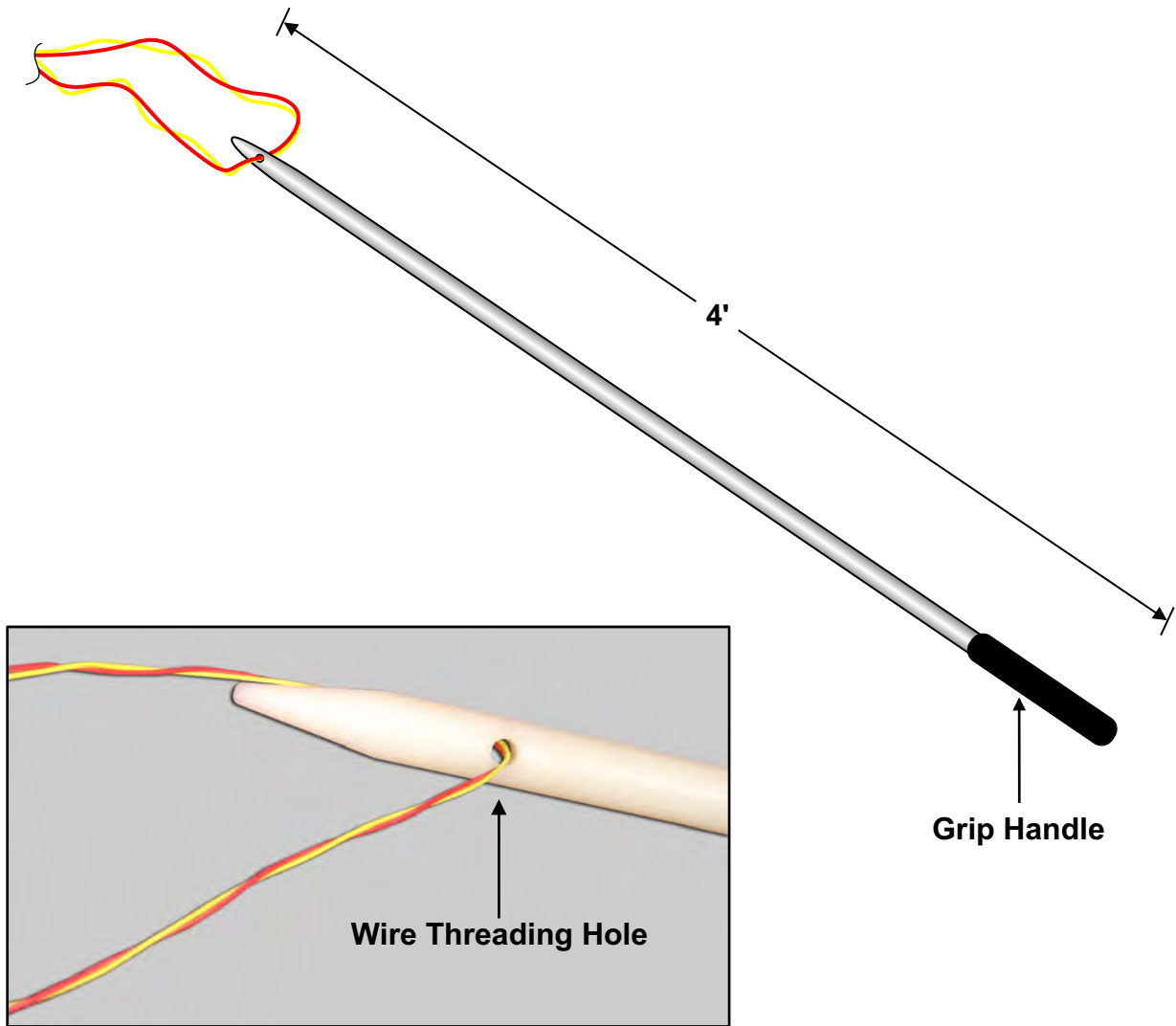

Application:

TAG's Wire Placement Pole (WPP-SF) is used to thread Frame Wire on the Main Distribution Frame (MDF) in the Central Office.

Ordering Information:

WPP-SF

Wire Placement Pole for Standard Frame

VZ ID #

1107 3239

150 Cooper Rd. (F-15)
W. Berlin, NJ 08091

www.tagcords.com

Telephone: (856) 753-8585
Fax : (856) 768-7645

Telecom Assistance Group

PUT THE BRAKES ON!!!

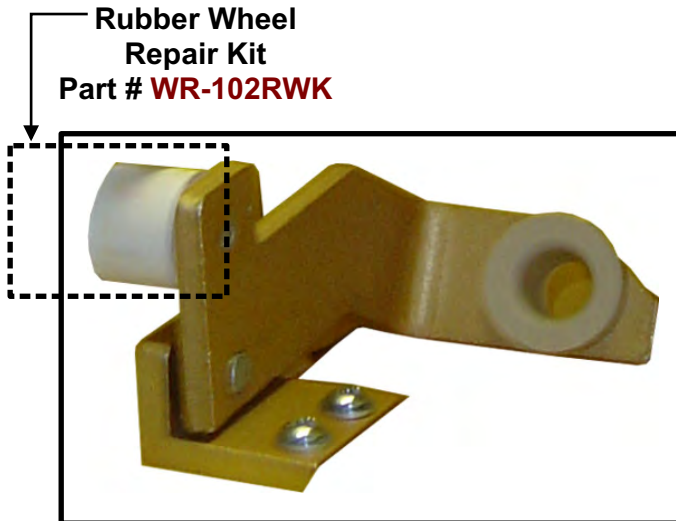

Rubber Wheel
Repair Kit
Part # **WR-102RWK**

Wire Reel Brake
Replacement
Part # **WR-102BRK**

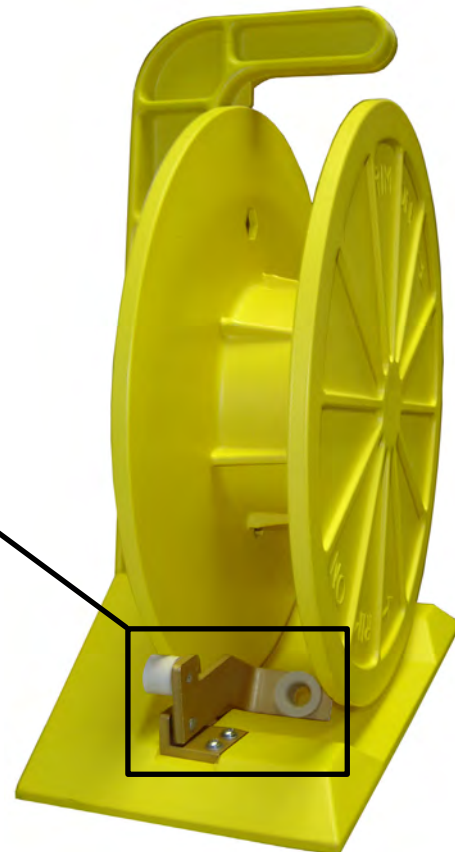

- ▶ *Avoid cross connect wire spool tangles and wasting of wire.*
- ▶ *The WR-102BRK replaces broken and/or worn-out brakes.*

Central Office Wire Reels

Ordering Information:

		<u>VZ ID #</u>
WR-102BRK	Cable Reel Brake Assembly w/ Grommet & Brake	1104 3381
WR-102RWK	Rubber Wheel Repair Kit includes (4) Rubber Wheels & (4) Retaining Spring Clips	1104 7974

150 Cooper Rd. (F-15)
W. Berlin, NJ 08091







www.tagcords.com

Telephone: (856) 753-8585
Fax : (856) 768-7645

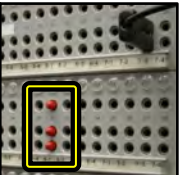
Telecom Assistance Group

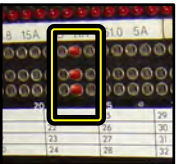
**KIT VZ Material ID #
1105 3270**

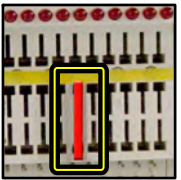

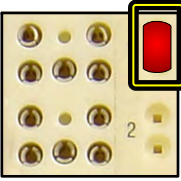
Dummy Plugs

QTY / PN # / DESC.	(not to scale)	
(20) 310DP 310 Dummy Plug	 VZ ID # 700 262 684 (QTY of 1)	
(20) 210DP Bantam Dummy Plug	 VZ ID # 1105 5520 (QTY of 1)	
(8) 800DP 800 DSX Dummy Plug	 VZ ID # 700 264 167 (QTY of 1)	
(10) 453ADP 453A Dummy Plug		

- Plugs into vacant 310 (PN # 310DP), bantam (PN # 210DP), 800 DSX (PN # 800DP) or 453A (PN # 453ADP) jacks
- Used to prevent accidental insertion / disruption of the circuit
- Identifies special circuits (i.e. SS7 circuits)





Protective Caps

Carrying Case Included

QTY / PN #	Description	(not to scale)
(50) SS7-2P	SS7 2 Pin Cap (1/2)	
(50) SS7-3P	SS7 3 Pin Cap (5/8)	
(24) SS7-6P	SS7 6 Pin Cap (1 3/8)	

- Placed over wire wrap terminals at MDF Frames
- Identifies special circuits (i.e. SS7 circuits)

Labels & Tags

PN #	Description / QTY	(approx. size)
SS7-LB1	SS7 Labels, (SM) VZ ID #: 1105 6750 (QTY of 50)	
SS7-LB2	SS7 Labels, Rectangle (SM) VZ ID #: 1110 1991 (QTY of 50)	
SS7-LB3	SS7 Labels, Rectangle (LG) VZ ID #: 1110 1992 (QTY of 25)	
SS7-LBL3B	SS7 Labels, Rectangle (XLG) VZ ID #: 1126 2947 (QTY of 25)	
SS7-TAG	SS7 Threaded Tag VZ ID #: 1128 0030 (QTY of 50)	

150 Cooper Rd. (F-15)
W. Berlin, NJ 08091

www.tagcords.com

Telecom Assistance Group

Telephone: (856) 753-8585

Fax : (856) 768-7645

BUTT-SET MULTI-CORDS

PART # 2-ADE-5

471A Jack to Alligator Clips / 463A Protector / 453A, (5')

VZ ID # 1106 2881

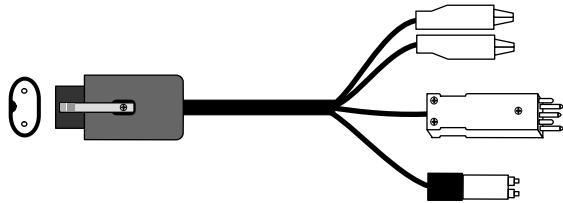

- Mates with 346 plug (Butt-Sets)

PART # 2-ACH-4

471A Jack to Alligator Clips / Wire Wraps / 526A, (4')

VZ ID # 1125 8426

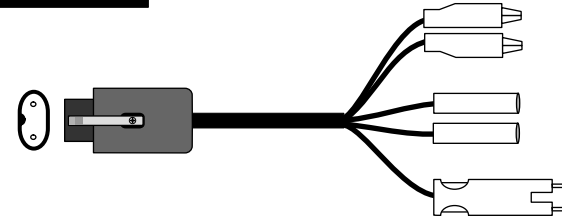

- Mates with 346 plug (Butt-Sets)

PART # 2-ACGH-4

471A Jack to Alligator Clips / Wire Wraps / 310 / 526A, (4')

VZ ID # 1125 8425

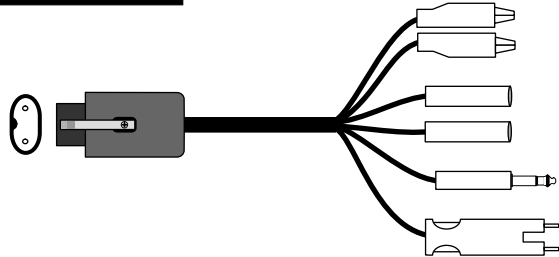

- Mates with 346 plug (Butt-Sets)

PART # 2-ACEHP-4

471A Jack to Alligator Clips / Wire Wraps / 453A / 526A / 310 MDF, (4')

VZ ID # 1125 8427

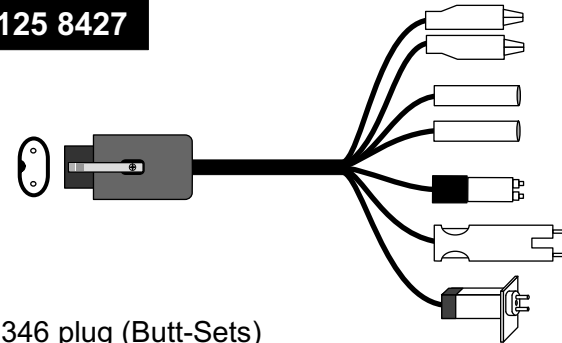

- Mates with 346 plug (Butt-Sets)

**TAG CAN MAKE BUTT-SET MULTI-CORDS
SPECIFICALLY TO YOUR DESIGN**
*PLEASE CALL 856-753-8585 FOR MORE INFORMATION
OR VISIT WWW.TAGCORDS.COM*

PART # 400471WP

471A Jack to Wire Wraps, (3')

VZ ID # 700 264 311



- Mates with 346 plug (Butt-Sets)

Need a CMC 5151 Channel Chek Unit ?

***TAG has a
Replacement Model for this
previously discontinued part....***

**DISCONTINUED
CMC 5151
CHANNEL CHEK UNIT
(YELLOW BOX)**



PN # T-D4CC
D4 Channel Check Unit



Application:

TAG's PN # T-D4CC replaces defective CMC 5151 Chek Units which are currently discontinued by the manufacturer.

Ordering Information:

T-D4CC

D4 Channel Check Unit

VZ ID #

1136 9551

150 Cooper Rd. (F-15)
W. Berlin, NJ 08091

www.tagcords.com

Telephone: (856) 753-8585
Fax : (856) 768-7645

Telecom Assistance Group

Portable "R" - HDSL Test Unit Kit

RHDSL-BST01

RHDSL-BST01
Portable "R" -
HDSL Test Unit Kit

VZ ID # (KIT)
1137 1496



(1) # 600509
 Carrying Case

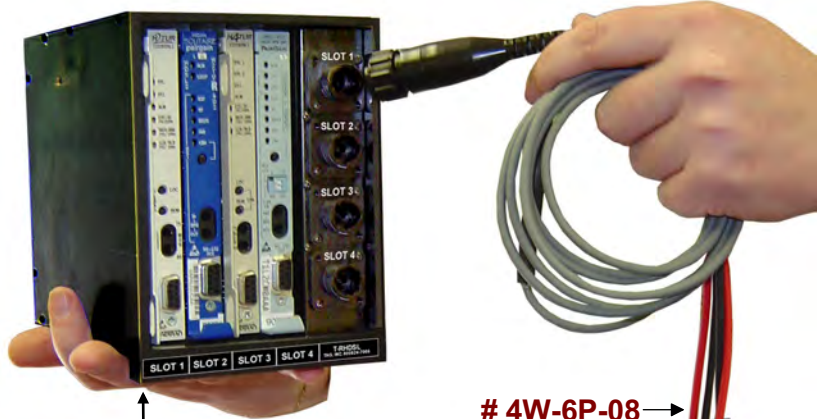

(cards not included)

4W-6P-08

- ▶ **4 Slots for 200/400 Mech. HDSL "R" Cards**
- ▶ **Rugged Connectors**
- ▶ **Various Test Cords**

(1) # 4W-6P-08
 Female Lock Plug to
 (4) 6P Alligator Clips, (8')

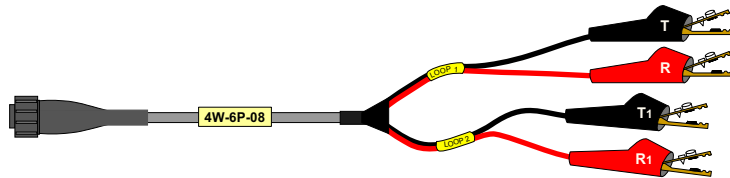

(1) # 4W-463Y-08
 Female Lock Plug to
 5 Pin "Y" Protector, (8')

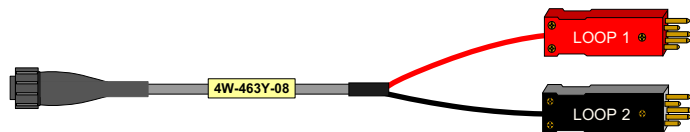

Ordering Information:

RHDSL-BST01 Portable "R" - HDSL Test Unit Kit (w/ 6P Alligators)
 includes: (1) T-RHDSL, (1) 4W-6P-08, (1) 4W-463Y-08 & (1) 600509

VZ ID #
1137 1496

T-RHDSL	Portable "R" - HDSL Test Unit (requires test cords)	1104 3643
4W-463Y-08	Female Lock Plug to 5 Pin "Y" Protector, (8')	1104 3645
600509	Carrying Case	1104 3641
4W-6P-16	Female Lock Plug to (4) 6P Alligator Clips, (16')	1131 4133
4W-A-08	Female Lock Plug to (4) Std Alligator Clips, (8')	1104 3644
RHDSL-KIT4	Portable "R" - HDSL Test Unit Kit (w/ Standard Alligators) includes: (1) T-RHDSL, (1) 4W-A-08, (1) 4W-463Y-08 & (1) 600509	1104 3646

150 Cooper Rd. (F-15)
 W. Berlin, NJ 08091

www.tagcords.com

Telephone: (856) 753-8585
 Fax : (856) 768-7645

Telecom Assistance Group

Portable "C" - HDSL Powering Test Unit Kit

PHTUC-KIT01VZ



PHTUC-KIT01VZ
Portable "C" - HDSL Powering Test Unit Kit

VZ ID # (KIT) 1104 3635

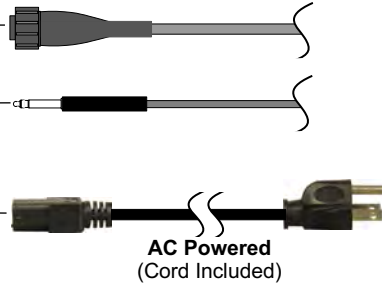

AC Powered
(Cord Included)



(card not included)

(1) PHTUC-01
Portable "C" - HDSL Powering Test Unit
w/ AC Power Cord

VZ ID # 1104 3636

(1) 4C-6P-08
Male Lock Plug to
(4) 6P Alligator Clips, (8')

VZ ID #
1104 3637

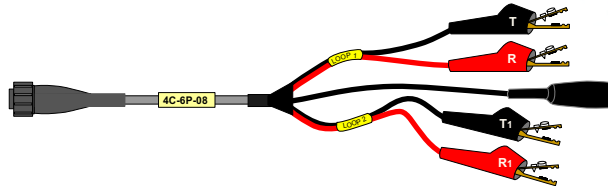

(1) 600510
Carrying Case

VZ ID #
1105 4904

Ordering Information:

PHTUC-KIT01VZ

Portable "C" - HDSL Powering Test Unit Kit

Includes: (1) PHTUC-01, (1) 4C-6P-08 & (1) 600510- Carrying Case

VZ ID # (KIT)
1104 3635

Additional Accessories Available

4C-463Y-08
Male Lock Plug to
5 Pin "Y" Protector, (8')

VZ ID #
1104 3638

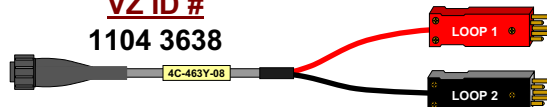

400210BK
Bantam to Bantam - Black, (6')

VZ ID #
1104 3639

4C-PORTY-08
Male Lock Plug to
Porta "Y", (8')

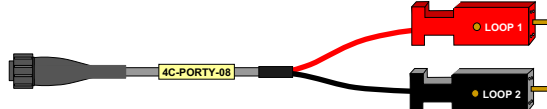

400210RD
Bantam to Bantam - Red, (6')

VZ ID #
1104 3640

4C-412Y-08
Male Lock Plug to
412 "Y", (8')

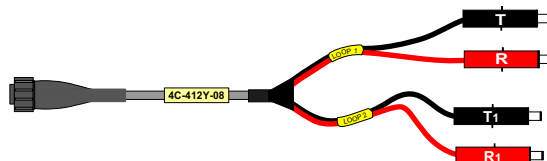

150 Cooper Rd. (F-15)
W. Berlin, NJ 08091

www.tagcords.com

Telephone: (856) 753-8585

Fax : (856) 768-7645

Telecom Assistance Group

TAG Fiber Streakers (2.5mm & 1.25mm)

**Fiber Streakers
for 2.5mm (TFS-208)
& 1.25mm (TFS-210)
Connectors - Including
SC, ST, FC & LC**

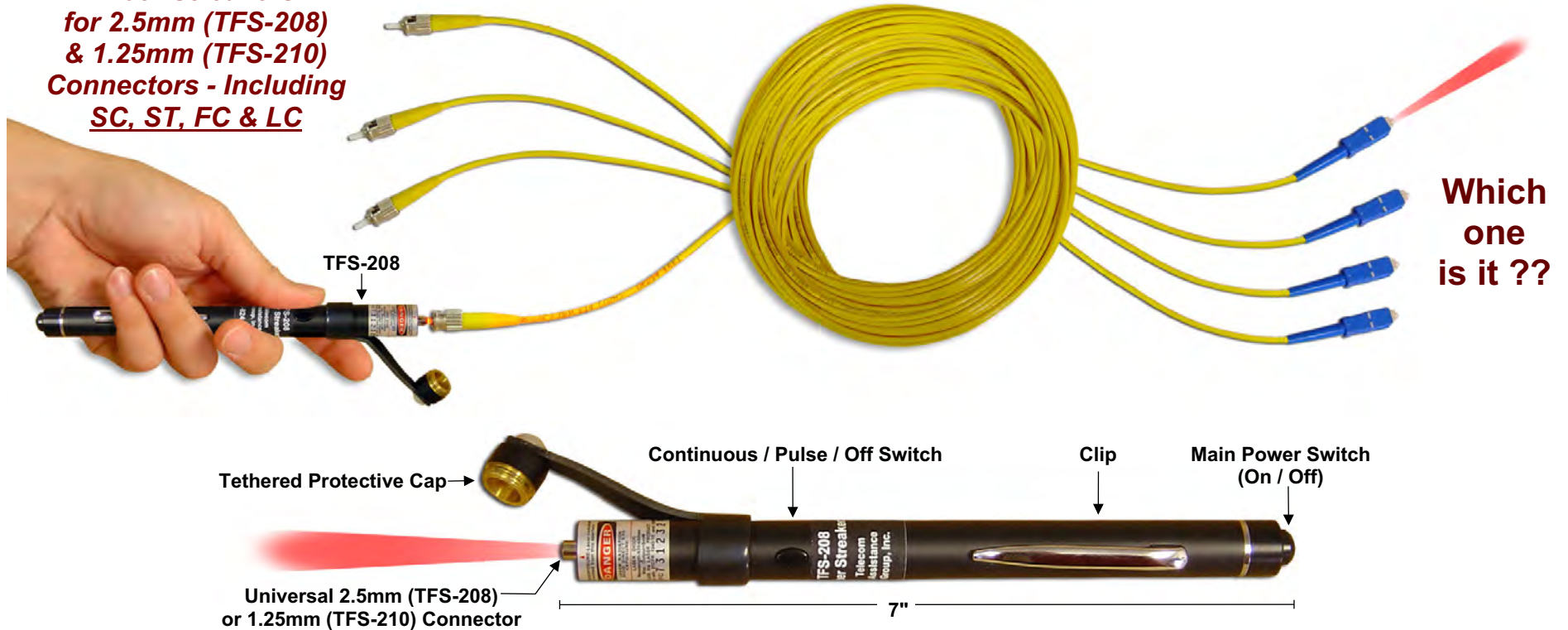

**Which
one
is it ??**

- ▶ Available with 2.5mm (TFS-208) & 1.25mm (TFS-210) receptacles for singlemode and multimode fibers
- ▶ The TFS-208 accepts any connector with a 2.5mm ferrule including SC, ST & FC connectors
- ▶ The TFS-210 accepts any connector with a 1.25mm ferrule including LC connectors
- ▶ Continuous and pulsed operation modes ▶ High visibility up to 3 km ▶ 650 nm laser output

Ordering Information:

		<u>VZ ID #</u>
TFS-208	Tag Fiber Streaker (2.5mm) - includes: (1) carrying case & (2) AAA batteries	1105 1182
TFS-210	Tag Fiber Streaker (1.25mm) - includes: (1) carrying case & (2) AAA batteries	1105 2921

150 Cooper Rd. (F-15)
W. Berlin, NJ 08091

www.tagcords.com

Telecom Assistance Group

Telephone: (856) 753-8585
Fax: (856) 768-7645

Fiber Optic Test Cords Included in Kit:

Carrying Case included with Kit



(2) 430773UAM-03
SC/APC to LC/UPC, Singlemode Simplex, 3.0mm yellow,
Test Cord, 3 Meters



(2) 430766AAM-03
SC/APC to SC/APC, Singlemode Simplex, 3.0mm yellow,
Test Cord, 3 Meters



(2) 430773AAM-03
SC/APC to LC/APC, Singlemode Simplex, 3.0mm yellow,
Test Cord, 3 Meters



(2) 430766AM-03
SC/APC to SC/UPC, Singlemode Simplex, 3.0mm yellow,
Test Cord, 3 Meters



(2) 430779AM-03
SC/APC to ST/UPC, Singlemode Simplex, 3.0mm yellow,
Test Cord, 3 Meters



(2) 430770AM-03
SC/APC to FC/UPC, Singlemode Simplex, 3.0mm yellow,
Test Cord, 3 Meters



(2) 430778AM-03
SC/APC to D4/UPC, Singlemode Simplex, 3.0mm yellow,
Test Cord, 3 Meters

Fiber Optic Adapters Included in Kit:

- | | | | |
|--|---|--|---|
| (1) 400766C
SC to SC
Simplex
UPC Coupler | (1) 400766AC
SC to SC
Simplex
APC Coupler | (1) 400781C
LC to LC
Simplex
UPC Coupler | (1) 400781AC
LC to LC
Simplex
APC Coupler |
| | | | |
| (1) 400758C
ST to ST
Simplex
UPC Coupler | (1) 400752C
FC to FC
Simplex
UPC Coupler | (1) 400756C
D4 to D4
Simplex
UPC Coupler | |
| | | | |

Ordering Information:

FOTC-KIT2
Fiber Optic Test Cord Kit 2

includes: (14) Test Cords, (7) Adapters & (1) Carrying Case (not shown)

VZ ID #
1136 7387