

TT-DCAPCE Quick Guide

QUICK GUIDE FOR 5ESS (DUAL SESSION) SWITCH ACCESS TERMINALS

CONTENTS:

5ESS SWITCH ACCESS TERMINAL CONFIGURATION	Page	1
TERMINAL COMMAND KEYS	Page	2
GENERAL SETTINGS NOTE	Page	3
TERMINAL SETUP	Page	4
CHANGING THE SERIAL PORT SETTINGS	Page	5
CHANGING THE HOST SETTINGS	Page	6
CHANGING THE SCREEN DISPLAY TO FULL OR SPLIT SCREEN	Page	7
PROGRAMMING FUNCTION KEYS	Page	8
CHANGING THE SCREEN TITLE	Page	9
5ESS DEFAULT SETUP	Page	10
STP-ALU DEFAULT SETTINGS	Page	11
DEX600 DEFAULT SETTINGS	Page	11
NOTES & TIPS	Pgs.	12-15
5ESS INSTALLATION NOTES	Pgs.	13-15



TT-DCAPCE Quick Guide

5ESS SWITCH ACCESS TERMINAL CONFIGURATION

FIGURE 1

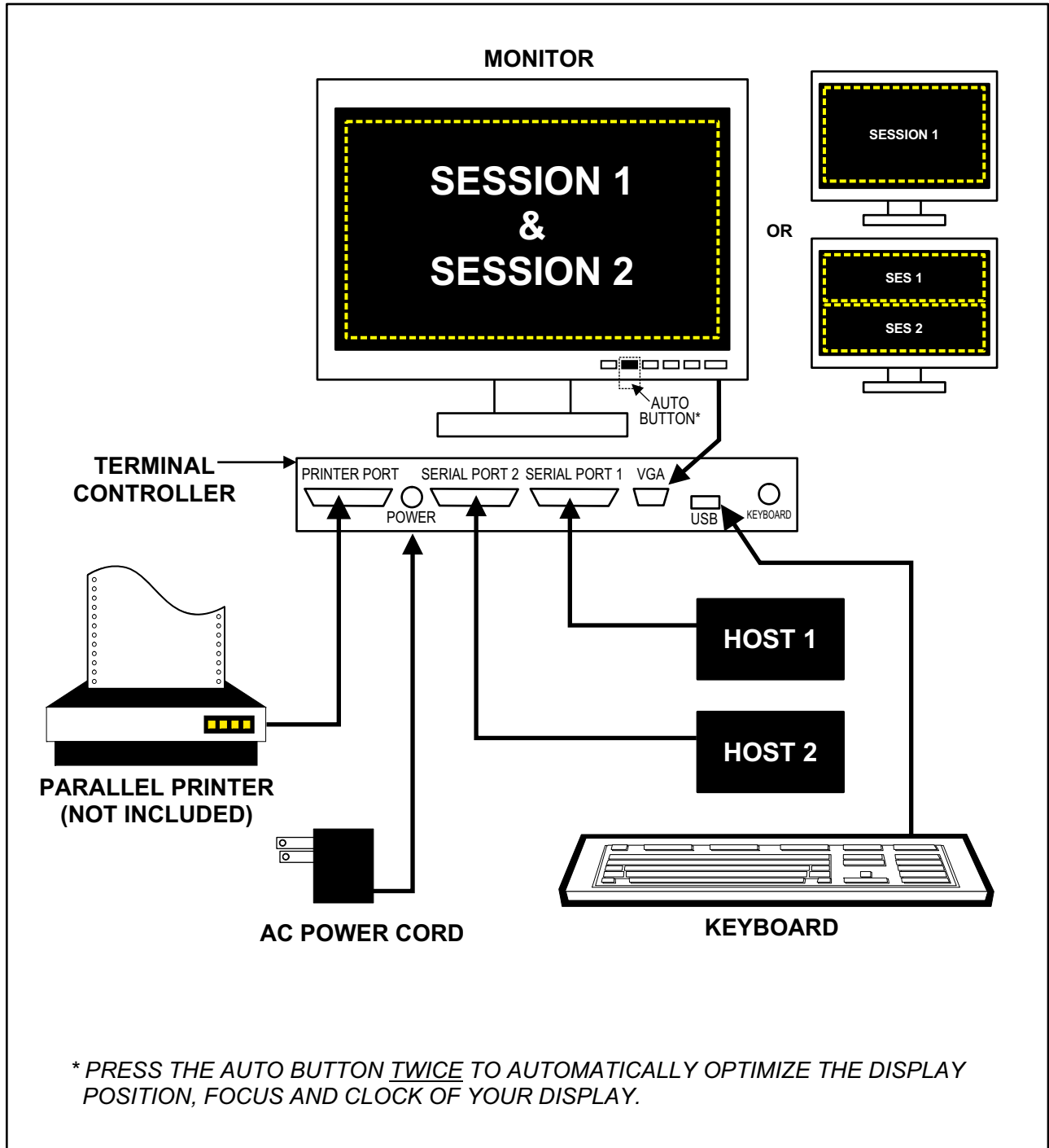



** PRESS THE AUTO BUTTON TWICE TO AUTOMATICALLY OPTIMIZE THE DISPLAY POSITION, FOCUS AND CLOCK OF YOUR DISPLAY.*

TT-DCAPCE Quick Guide

TERMINAL COMMAND KEYS

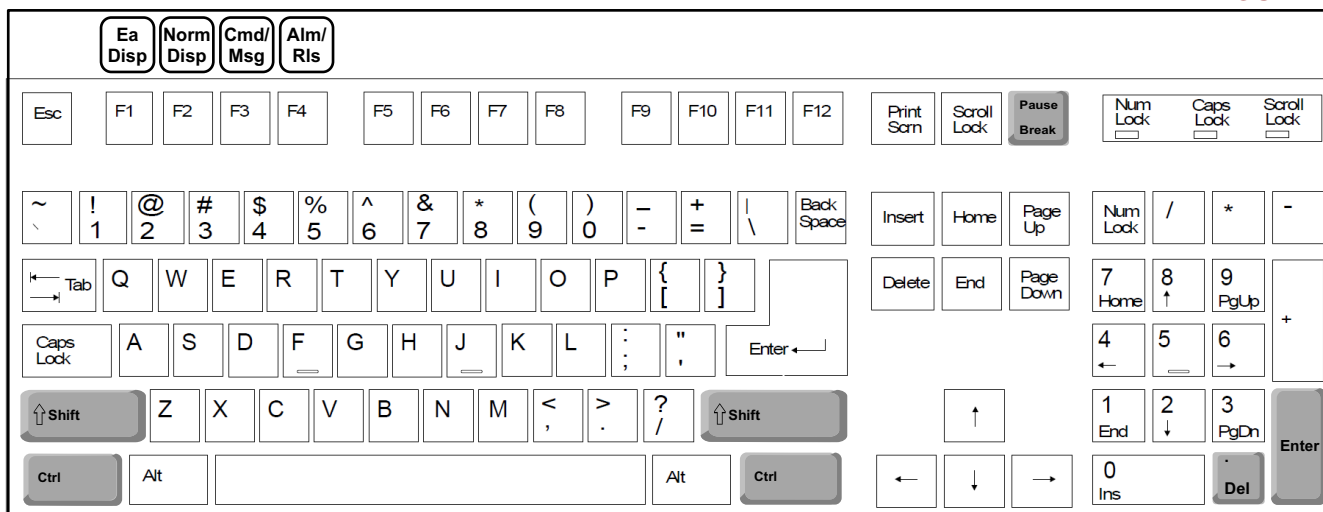
FIGURE 2

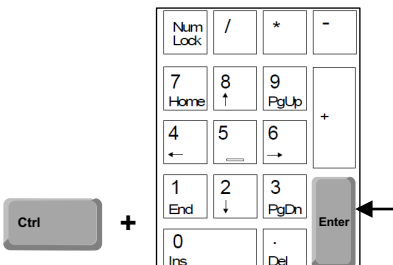
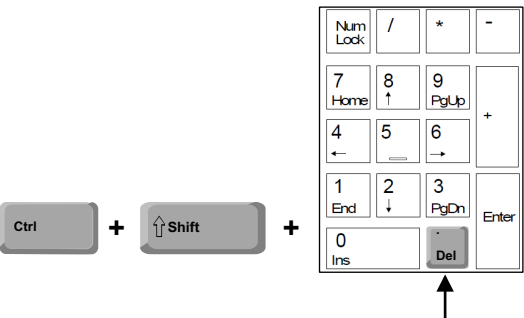

<p>SWITCH SESSIONS (for dual sessions only)</p>	<p>Press Ctrl + Enter (Enter on the Number Pad)</p> 
<p>PRINT</p>	<p>Press Ctrl + Shift + . (Decimal on the Number Pad)</p> 
<p>SEND BREAK</p>	<p>Press Ctrl + Pause/Break Key</p> 

TT-DCAPCE Quick Guide

GENERAL SETTINGS NOTE

Terminals are supplied pre-configured for your 5ESS switch. Some local settings may need to be adjusted. Example: Baud Rate, Function Keys etc.

The following pages show how to make adjustments to the terminal when required.

TT-DCAPCE Quick Guide

TERMINAL SETUP

FIGURE 3

Parameters Save all? (Y/N)

Emulation=VT-100
Comm Mode=Full Duplex
Enhanced=On
Host/Printer=SER1/Para

SER1 Baud Rate = 4800
SER2 Baud Rate=4800
Language=U.S.

SER1 Data Format=7/1/E
SER2 Data Format=7/1/E
Sessions=Two

Choices

300 600 1200 2400 **4800** 9600 19200

Select

↑ → ↓ ← : Parameter Enter/S-Enter : Next/Prev Choice Exit : Pause Key

Session 1 Press <Control> <EnterKpd> to Toggle Session

FIGURE 4

ENTER SETUP SCREEN	Press Ctrl + Scroll Lock
SELECT MENU	Press F1 - Prt Scn <i>(see pg. 10 for 5ESS Default Setup)</i> <i>(see pg. 11 for STP-ALU Default Setup)</i>
NAVIGATE PARAMETERS	Press the Arrow Keys
NAVIGATE CHOICES	Press Enter or Spacebar (moves forward)
	Press Shift + Enter (moves backward)
EXIT SETUP SCREEN	Press the Pause Key (when prompted to "Save all", press Y key to Save or N key to discard)

TT-DCAPCE Quick Guide

CHANGING THE SERIAL PORT SETTINGS*

***Note:** Port settings must be set for both sessions.

FIGURE 5A

F1 Quick	F2 Genrl	F3 Displ	F4 Kybd	F5 Keys	F6 Ports	F7 Host	F8 Print	F9 Emul	F10 Tabs	F11 AnsBk	F12 Prog	PrtSc Exec	
Emulation=VT-100 Comm Mode=Full Duplex Enhanced=On Host/Printer=SER1/Para				Parameters				SER1 Baud Rate = 4800 SER2 Baud Rate=4800 Language=U.S.		SER1 Data Format=7/1/E SER2 Data Format=7/1/E Sessions=Two			
Choices													
300 600 1200 2400 4800 9600 19200													
Select													
↑→↓← : Parameter				Enter/S-Enter : Next/Prev Choice				Exit : Pause Key					
Session 1						Press <Control> <EnterKpd> to Toggle Session							

1. Press the **F1** button
2. Use the **Arrow Keys** to move to **SER1 Baud Rate (SER1 = Serial Port 1)**
3. Press **Enter** or **Spacebar** until the correct **Choice** is highlighted (4800 for 5ESS, 9600 for STP-ALU)
4. Use the **Arrow Keys** to move over to **SER1 Data Format**
5. Press **Enter** or **Spacebar** until the correct **Choice** is highlighted (7/1/E for 5ESS, 8/1/N for STP-ALU)
6. Press **<Control> <EnterKpd>** to **Toggle to Session 2** (see page 2 - "Switching Sessions")

FIGURE 5B

F1 Quick	F2 Genrl	F3 Displ	F4 Kybd	F5 Keys	F6 Ports	F7 Host	F8 Print	F9 Emul	F10 Tabs	F11 AnsBk	F12 Prog	PrtSc Exec	
Emulation=VT-100 Comm Mode=Full Duplex Enhanced=On Host/Printer=SER1/Para				Parameters				SER1 Baud Rate = 4800 SER2 Baud Rate=4800 Language=U.S.		SER1 Data Format=7/1/E SER2 Data Format=7/1/E Sessions=Two			
Choices													
300 600 1200 2400 4800 9600 19200													
Select													
↑→↓← : Parameter				Enter/S-Enter : Next/Prev Choice				Exit : Pause Key					
Session 2						Press <Control> <EnterKpd> to Toggle Session							

7. Use the **Arrow Keys** to move to **SER2 Baud Rate (SER2 = Serial Port 2)**
8. Press **Enter** or **Spacebar** until the correct **Choice** is highlighted (4800 for 5ESS, 9600 for STP-ALU)
9. When finished, press the **Pause Key** at the top right of the keyboard
10. When prompted with "**Save all?**", click **Y** to save the new **Parameters**

TT-DCAPCE Quick Guide

CHANGING THE HOST SETTINGS

FIGURE 6A

F1	F2	F3	F4	F5	F6	F7	F8	F9	F10	F11	F12	PrtSc
Quick	Genrl	Displ	Kybd	Keys	Ports	Host	Print	Emul	Tabs	AnsBk	Prog	Exec
Parameters												
Comm Mode=Full Duplex				Local=Off				Recv <CR>=<CR>				
Recv =Ignore				Null Suppress=On				Send Block Term=None				
Send Region=Screen				Send End=Region								
Choices												
Full Duplex				Half Duplex				Full Block		Half Block		
Select												
↑→↓← : Parameter				Enter/S-Enter : Next/Prev Choice				Exit : Pause Key				
Session 1 Press <Control> <EnterKpd> to Toggle Session												

1. Press the **F7** button
2. Use the **Arrow Keys** to move over to **Comm Mode**
3. Press **Enter** or **Spacebar** until the correct **Choice** is highlighted (Full Duplex for 5ESS)
Note: The common setting for 5ESS is either Full Duplex or Full Block
4. Press **<Control> <EnterKpd>** to **Toggle to Session 2** (see page 2 - "Switching Sessions")

FIGURE 6B

F1	F2	F3	F4	F5	F6	F7	F8	F9	F10	F11	F12	PrtSc
Quick	Genrl	Displ	Kybd	Keys	Ports	Host	Print	Emul	Tabs	AnsBk	Prog	Exec
Parameters											Save all? (Y/N)	
Comm Mode=Full Duplex				Local=Off				Recv <CR>=<CR>				
Recv =Ignore				Null Suppress=On				Send Block Term=None				
Send Region=Screen				Send End=Region								
Choices												
Full Duplex				Half Duplex				Full Block		Half Block		
Select												
↑→↓← : Parameter				Enter/S-Enter : Next/Prev Choice				Exit : Pause Key				
Session 2 Press <Control> <EnterKpd> to Toggle Session												

5. Use the **Arrow Keys** to move over to **Comm Mode** in session 2
6. Press **Enter** or **Spacebar** until the correct **Choice** is highlighted (Full Duplex for 5ESS)
Note: The common setting for 5ESS is either Full Duplex or Full Block
7. When finished, press the **Pause Key** at the top right of the keyboard
8. When prompted with "**Save all?**", click **Y** to save the new **Parameters**

TT-DCAPCE Quick Guide

CHANGING THE SCREEN DISPLAY TO FULL OR SPLIT SCREEN*

*Note: Applies to dual sessions only.

FIGURE 7

F1 Quick	F2 Genrl	F3 Displ	F4 Kybd	F5 Keys	F6 Ports	F7 Host	F8 Print	F9 Emul	F10 Tabs	F11 AnsBk	F12	PrtSc
Parameters												
Emulation=VT-100 Screen Saver=5-min Warning Bell=On Host/Printer=SER1/Para				Enhanced=On Auto Page=Off Bell Length=350 ms Sessions=Two				Auto Wrap=Off Auto Scroll=On Bell Volume=0 Session Display=Full				
Choices												
Full		Split										
Select												
↑ → ↓ ← : Parameter				Enter/S-Enter : Next/Prev Choice				Exit : Pause Key				
Session 1 Press <Control> <EnterKpd> to Toggle Session												

1. Press the **F2** button
2. Use the **Arrow Keys** to move over to **Session Display**
3. Press **Enter** or **Spacebar** until the correct **Choice** is highlighted (Full / Split)

FIGURE 8

F1 Quick	F2 Genrl	F3 Displ	F4 Kybd	F5 Keys	F6 Ports	F7 Host	F8 Print	F9 Emul	F10 Tabs	F11 AnsBk	F12 Prog	PrtSc Exec
Parameters											Save all? (Y/N)	
Page Length=24 Display Cursor=On Columns=80				Screen Length=26 Lines				Screen Video=Normal Auto Adjust Cursor=On Scroll Speed=Full				
Choices												
26 Lines		49 Lines										
Select												
↑ → ↓ ← : Parameter				Enter/S-Enter : Next/Prev Choice				Exit : Pause Key				
Session 1 Press <Control> <EnterKpd> to Toggle Session												

4. Press the **F3** button
5. Use the **Arrow Keys** to move over to **Screen Length**
6. Press **Enter** or **Spacebar** until the correct **Choice** is highlighted (26 Lines for Full Screen)
(49 Lines for Split Screen)
7. When finished, press the **Pause Key** at the top right of the keyboard
8. When prompted with "Save all?", click **Y** to save the new **Parameter**

TT-DCAPCE Quick Guide

PROGRAMMING FUNCTION KEYS*

*Each function key has (4) programmable registers per session such as **F/key**, **sh-F/key**, **ctrl-F/key** & **ctrl-sh-F/key**
 (These can be selected from the "Choices" located in the **"Program"** Parameter)

FIGURE 9

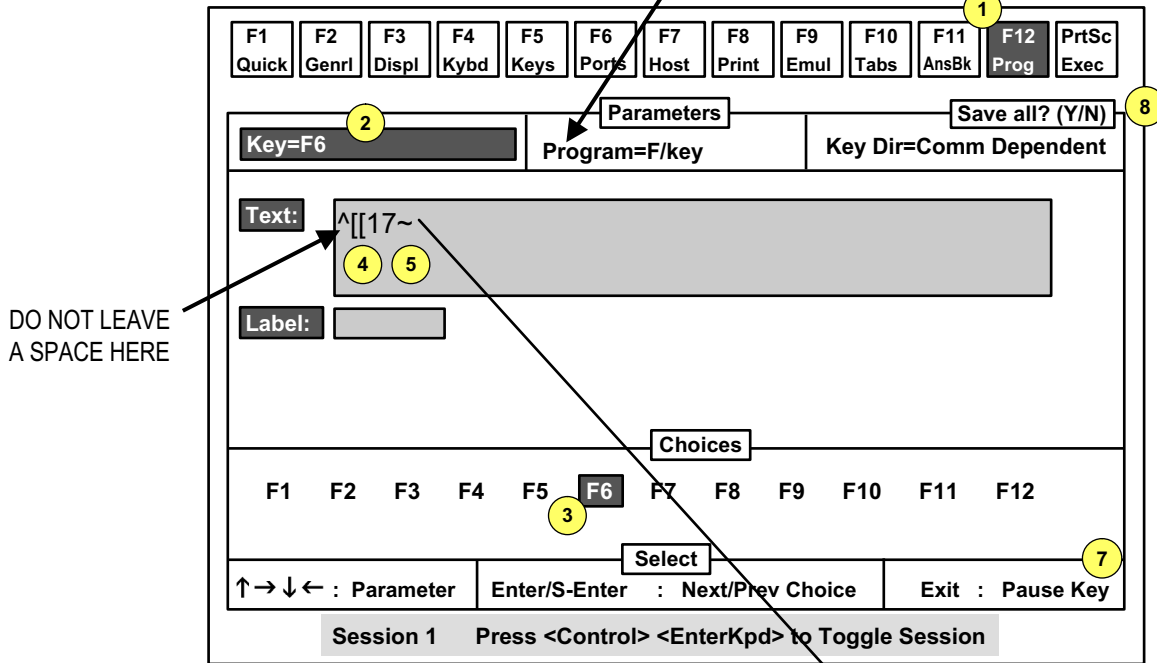

DO NOT LEAVE
A SPACE HERE

1. Press the **F12** button
2. The cursor will appear in the "Key" Field with F1 as the default (**DO NOT** change F1-F4)
3. Select a new function key to program by pressing **Enter** or **Spacebar** until the correct **Choice** is highlighted (for example choose F6)
4. Arrow down to move to the "Text" Field
5. Type in the "Function" for the key. *CAUTION: The first character in the Text Field cannot be left blank*
Example: To program **ESC[17~** Type: **Shift+6** **[[17** **Shift+`** = **(^[[17~)**
6. To program another function, arrow back up to the "Key" Field & repeat steps 3-5
7. When finished, press the **Pause Key** at the top right of the keyboard
8. When prompted with "Save all?", click **Y** to save the new **Parameter**

DO NOT CHANGE THE FUNCTIONS OF F1, F2, F3 & F4

TT-DCAPCE Quick Guide

CHANGING THE SCREEN TITLE

Note: This will change the title at the top of each Session.

FIGURE 10A

F1 Quick	F2 Genrl	F3 Displ	F4 Kybd	F5 Keys	F6 Ports	F7 Host	F8 Print	F9 Emul	F10 Tabs	F11 AnsBk	F12 Prog	PrtSc Exec
Parameters												
Answerback Mode=Off				Answerback Conceal								
Answerback Message: <input style="width: 100%;" type="text"/>												
Screen Title: <input style="width: 100%;" type="text" value="TT-DCAPCE 1_"/>												
Choices												
<Backspace> : Delete Character <Shift><Backspace> : Default Field												
Select												
↑→↓← : Parameter				Enter/S-Enter : Next/Prev Choice				Exit : Pause Key				
Session 1 Press <Control> <EnterKpd> to Toggle Session												

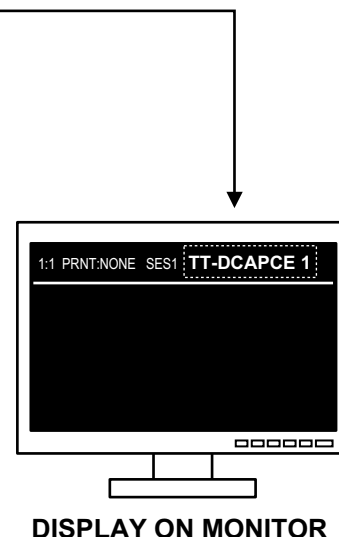

1. Press the **F11** button
- FOR SESSION 1**
2. Use the **Arrow Keys** to move the cursor down to **Screen Title**
3. Type in a Title for Session 1 (Example: TT-DCAPCE 1)
4. Press **<Control> <EnterKpd>** to Toggle to Session 2 (see page 2 - "Switching Sessions")

FIGURE 10B

F1 Quick	F2 Genrl	F3 Displ	F4 Kybd	F5 Keys	F6 Ports	F7 Host	F8 Print	F9 Emul	F10 Tabs	F11 AnsBk	F12 Prog	PrtSc Exec
Parameters											Save all? (Y/N)	
Answerback Mode=Off				Answerback Conceal								
Answerback Message: <input style="width: 100%;" type="text"/>												
Screen Title: <input style="width: 100%;" type="text" value="TT-DCAPCE 2_"/>												
Choices												
<Backspace> : Delete Character <Shift><Backspace> : Default Field												
Select												
↑→↓← : Parameter				Enter/S-Enter : Next/Prev Choice				Exit : Pause Key				
Session 2 Press <Control> <EnterKpd> to Toggle Session												

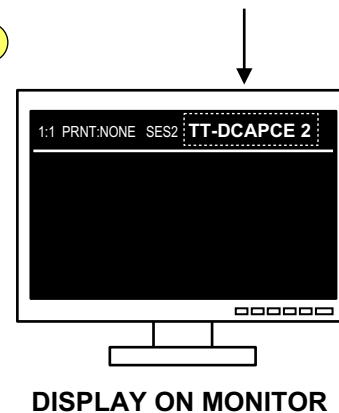

- FOR SESSION 2**
5. Use the **Arrow Keys** to move the cursor down to **Screen Title**
6. Type in a Title for Session 2 (Example: TT-DCAPCE 2)
7. When finished, press the **Pause Key** at the top right of the keyboard
8. When prompted with "Save all?", click **Y** to save the new **Parameters**

TT-DCAPCE Quick Guide

5ESS DEFAULT SETTINGS*

**Note: When using Dual Sessions, parameters must be set for both sessions.*

Note: Items in **Bold** may require Local Settings.

FIGURE 11

Menu	Key	Parameters Available (Not all will display for a given emulation, keyboard, or video mode)		
Quick	F1	Emulation = VT-100 Comm Mode = Full Duplex Enhanced = On Host/Printer = SER1/Para SER2/Para	SER1 Baud Rate = 4800 SER2 Baud Rate = 4800 Language = U.S.	SER1 Data Format = 7/1/E SER2 Data Format = 7/1/E Sessions = Two
General	F2	Emulation = VT-100 Screen Saver = Off Warning Bell = On Host/Printer = SER1/Para SER2/Para	Enhanced = On Auto Page = Off Bell Length = 350 ms Sessions = Two	Auto Wrap = On Auto Scroll = On Bell Volume = 0 Session Display = Full
Display	F3	Page Length = 24 Display Cursor = On Columns = 80	Screen Length = 26 Lines Cursor = Blink Block Erase Color = Black	Screen Video = Normal Auto Adjust Cursor = On Scroll Speed = Full
Keyboard	F4	Language = U.S. Key Click = On Num Lock = Toggle	Char Set Mode = ANSI Key Repeat = Off Key Lock = Reverse	Margin Bell = Off Key Rate = 20 cps Caps Lock = Toggle
Keys	F5	Enter Key = <CR> Alt Key = Compose UDKS = Emul Dependent	Return Key = <CR> Disconnect = Pause	Backspace = <BS>/<BS> Return Key Repeat = Off
Ports	F6	SER1 Baud Rate = 4800 SER2 Baud Rate = 4800 SER1 Xmt = Xon-Xoff SER2 Xmt = Xon-Xoff SER1 Break = 250 ms SER2 Break = 250 ms	SER1 Data Format = 7/1/E SER2 Data Format = 7/1/E SER1 Recv = Xon-Xoff(XPC) SER2 Recv = Xon-Xoff(XPC) SER1 Modem Control = Off SER2 Modem Control = Off	SER1 Parity Check = Off SER2 Parity Check = Off SER1 Xmt Pace = Baud SER2 Xmt Pace = Baud SER1 Disconnect = 2 sec SER2 Disconnect = 2 sec
Host	F7	Comm Mode = Full Duplex Recv = Ignore Send Region = Screen	Local = Off Null Suppress = On Send End = Region	Recv <CR> = <CR> Send Block Term = None
Print	F8	Prnt Mode = Normal	Prnt Region = Screen	Prnt Block = None
Emulation	F9	Numeric Kpd = Numeric ANSI-ID = VT220 Status Line = Indicator	Cursor Kpd = Cursor Feature Lock = Off	Send Data = All Function Key Lock = Off
Tabs	F10	Auto Init Tabs = Off	Default Tabs	
Answerback	F11	Answerback Mode = Off	Answerback Conceal	
Program	F12	Key = F6 Text: rst:aivlc	Program = F/Key	Key Dir = Comm Dependent
Execute	Prt Sc	Save Terminal Save Session Reset Terminal Clear Screen Terminal Version	Recall Terminal Recall Session Reset Session Default Session UDKS	Default Terminal Default Session Reset Ports Update Terminal
Exit Setup	Pause	Save all? (Y/N)		

SER1 = SERIAL PORT 1

SER2 = SERIAL PORT 2

TT-DCAPCE Quick Guide

STP-ALU DEFAULT SETTINGS*

DEX600 DEFAULT SETTINGS*

***Note:** When using Dual Sessions, parameters must be set for both sessions.

Note: Items in **Bold** may require Local Settings.

FIGURE 12

Menu	Key	Parameters Available (Not all will display for a given emulation, keyboard, or video mode)		
Quick	F1	Emulation = VT-100 Comm Mode = Full Duplex Enhanced = On Host/Printer = SER1/Para SER2/Para	SER1 Baud Rate = 9600 SER2 Baud Rate = 9600 Language = U.S.	SER1 Data Format = 8/1/N SER2 Data Format = 8/1/N Sessions = Two
General	F2	Emulation = VT-100 Screen Saver = Off Warning Bell = On Host/Printer = SER1/Para SER2/Para	Enhanced = On Auto Page = Off Bell Length = 350 ms Sessions = Two	Auto Wrap = On Auto Scroll = On Bell Volume = 0 Session Display = Full
Display	F3	Page Length = 24 Display Cursor = On Columns = 80	Screen Length = 26 Lines Cursor = Blink Block Erase Color = Black	Screen Video = Normal Auto Adjust Cursor = On Scroll Speed = Full
Keyboard	F4	Language = U.S. Key Click = On Num Lock = Toggle	Char Set Mode = ANSI Key Repeat = Off Key Lock = Reverse	Margin Bell = Off Key Rate = 20 cps Caps Lock = Toggle
Keys	F5	Enter Key = <CR> Alt Key = Compose UDKS = Emul Dependent	Return Key = <CR> Disconnect = Pause	Backspace = <BS>/<BS> Return Key Repeat = Off
Ports	F6	SER1 Baud Rate = 9600 SER2 Baud Rate = 9600 SER1 Xmt = Xon-Xoff SER2 Xmt = Xon-Xoff SER1 Break = 250 ms SER2 Break = 250 ms	SER1 Data Format = 8/1/N SER2 Data Format = 8/1/N SER1 Recv = Xon-Xoff(XPC) SER2 Recv = Xon-Xoff(XPC) SER1 Modem Control = Off SER2 Modem Control = Off	SER1 Parity Check = Off SER2 Parity Check = Off SER1 Xmt Pace = Baud SER2 Xmt Pace = Baud SER1 Disconnect = 2 sec SER2 Disconnect = 2 sec
Host	F7	Comm Mode = Full Duplex Recv = Ignore Send Region = Scroll	Local = Off Null Suppress = On Send End = Region	Recv <CR> = <CR> Send Block Term = None
Print	F8	Prnt Mode = Normal	Prnt Region = Screen	Prnt Block = None
Emulation	F9	Numeric Kpd = Numeric ANSI-ID = VT-100 Status Line = Indicator	Cursor Kpd = Cursor Feature Lock = Off	Send Data = All Function Key Lock = Off
Tabs	F10	Auto Init Tabs = Off	Default Tabs	
Answerback	F11	Answerback Mode = Off	Answerback Conceal	
Program	F12	Key = F6 Text: rst:aivlc	Program = F/Key	Key Dir = Comm Dependent
Execute	Prt Sc	Save Terminal Save Session Reset Terminal Clear Screen Terminal Version	Recall Terminal Recall Session Reset Session Default Session UDKS	Default Terminal Default Session Reset Ports Update Terminal
Exit Setup	Pause	Save all? (Y/N)		

SER1 = SERIAL PORT 1

SER2 = SERIAL PORT 2

TT-DCAPCE Quick Guide

NOTES & TIPS

5ESS INSTALLATION NOTES Pgs. 13-15

NOTES & TIPS**5ESS INSTALLATION NOTES**

A. WHEN THE TERMINAL IS FIRST INSTALLED, THE SCROLLING REGION IS NOT ESTABLISHED.

1. RE-ESTABLISH THE SCROLLING REGION BY ENTERING PAGE 120 (NOTES).
2. GO TO THE TOP ZONE TO CLEAR THE SCREEN.
3. THEN EXIT PAGE 120 BACK TO THE PAGE YOU WERE ON (PAGE 100 FOR EXAMPLE).

B. THE EMERGENCY ACTION KEY (F1) MAY BE DISABLED IN THE SWITCH -

THE TERMINAL SENDS THE PROPER EA CODE BUT THE 5ESS DOES NOT RESPOND BECAUSE EA IS DISABLED AT THE TERMINAL.

NOTES & TIPS

5ESS INSTALLATION NOTES

IF YOU HAVE:

- 25 PIN MALE (RS-232) CONNECTOR FROM THE SWITCH, PLUG IT TO THE TERMINAL AS SHOWN (SEE FIGURE 13)
- 25 PIN FEMALE (RS-232) CONNECTOR FROM THE SWITCH, USE THE INCLUDED GENDER CHANGERS & PLUG IT TO THE TERMINAL

FIGURE 13

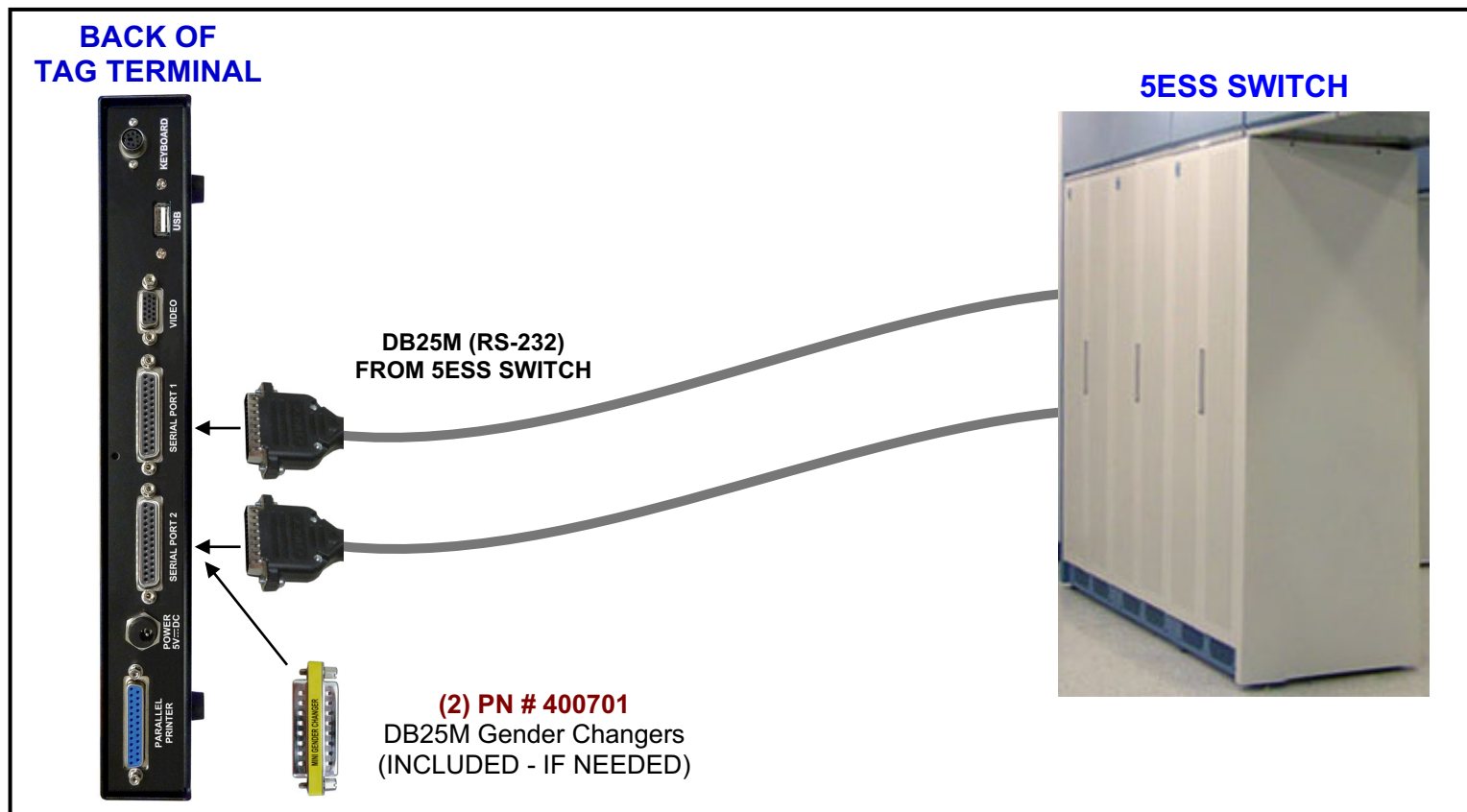

150 Cooper Rd. (F-15)
W. Berlin, NJ 08091

www.tagcords.com
Telecom Assistance Group

Telephone: (856) 753-8585
Fax : (856) 768-7645

NOTES & TIPS

5ESS INSTALLATION NOTES

IF YOU HAVE:

- OPTO ADAPTER WITH SMA 906 MULTIMODE FIBER CORDS FROM THE SWITCH, PLUG IT TO THE TERMINAL
- CHECK THE SETTINGS AS SHOWN (SEE FIGURE 15)

FIGURE 14

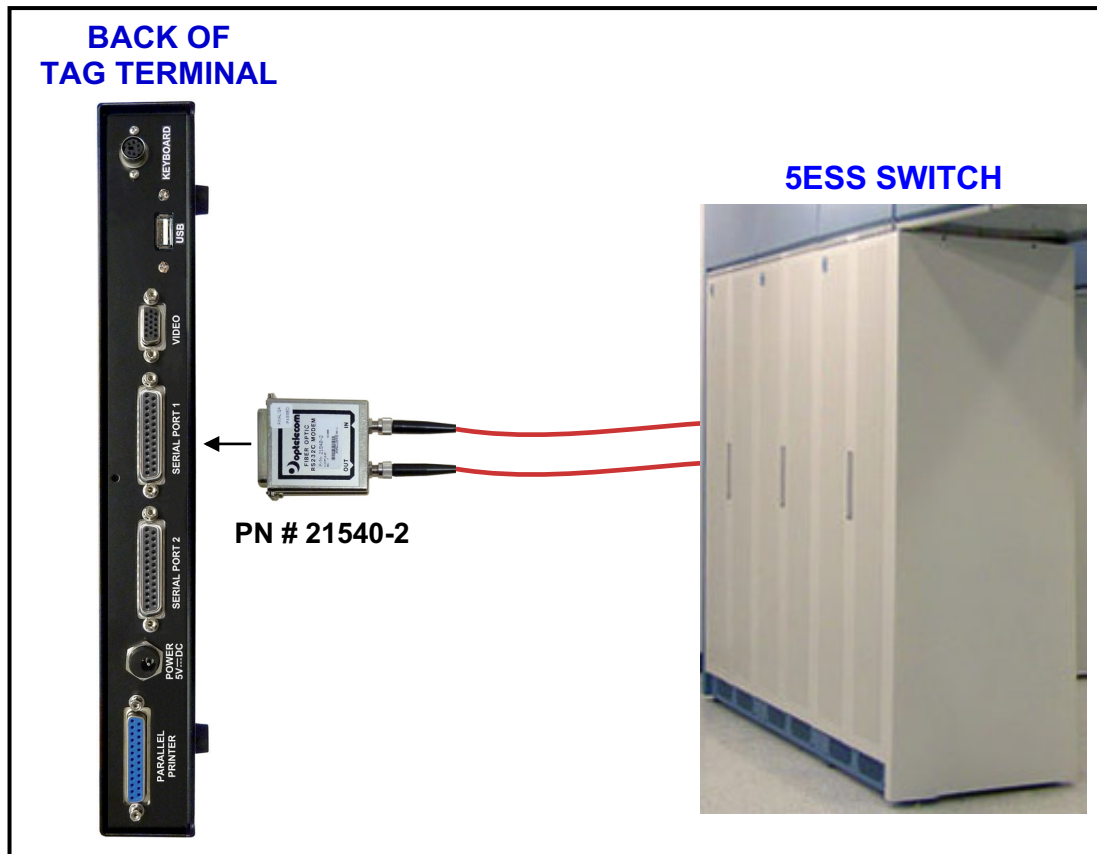
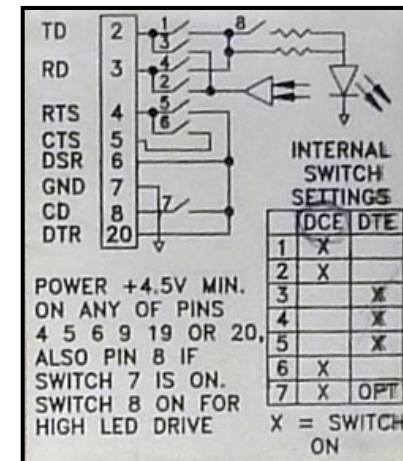

FIGURE 15

BACK LABEL OF PN # 21540-2



SETTINGS:

- MODEL OPTELECOM FIBER OPTIC RS232C MODEM (PN # 21540-2) OUT PUTS ON DB25 MALE.
- SET UP PER BACK LABEL "DCE", OUT ON PIN 3, IN ON PIN 20 TO 8 & 6 & 4.