

TT-DCAG5 Quick Guide

QUICK GUIDE FOR GTD 5 (DUAL SESSION) SWITCH ACCESS TERMINALS

CONTENTS:

GTD 5 SWITCH ACCESS TERMINAL CONFIGURATION Page 1

TERMINAL COMMAND KEYS Page 2

NUMERIC KEYPAD FUNCTIONS Page 3

GENERAL SETTINGS NOTE Page 4

TERMINAL SETUP Page 5

CHANGING THE SERIAL PORT SETTINGS Page 6

**CHANGING THE SCREEN DISPLAY TO FULL
OR SPLIT SCREEN Page 7**

PROGRAMMING FUNCTION KEYS Page 8

CHANGING THE SCREEN TITLE Page 9

GTD 5 DEFAULT SETTINGS Page 10



TT-DCAG5 Quick Guide

GTD 5 SWITCH ACCESS TERMINAL CONFIGURATION

FIGURE 1

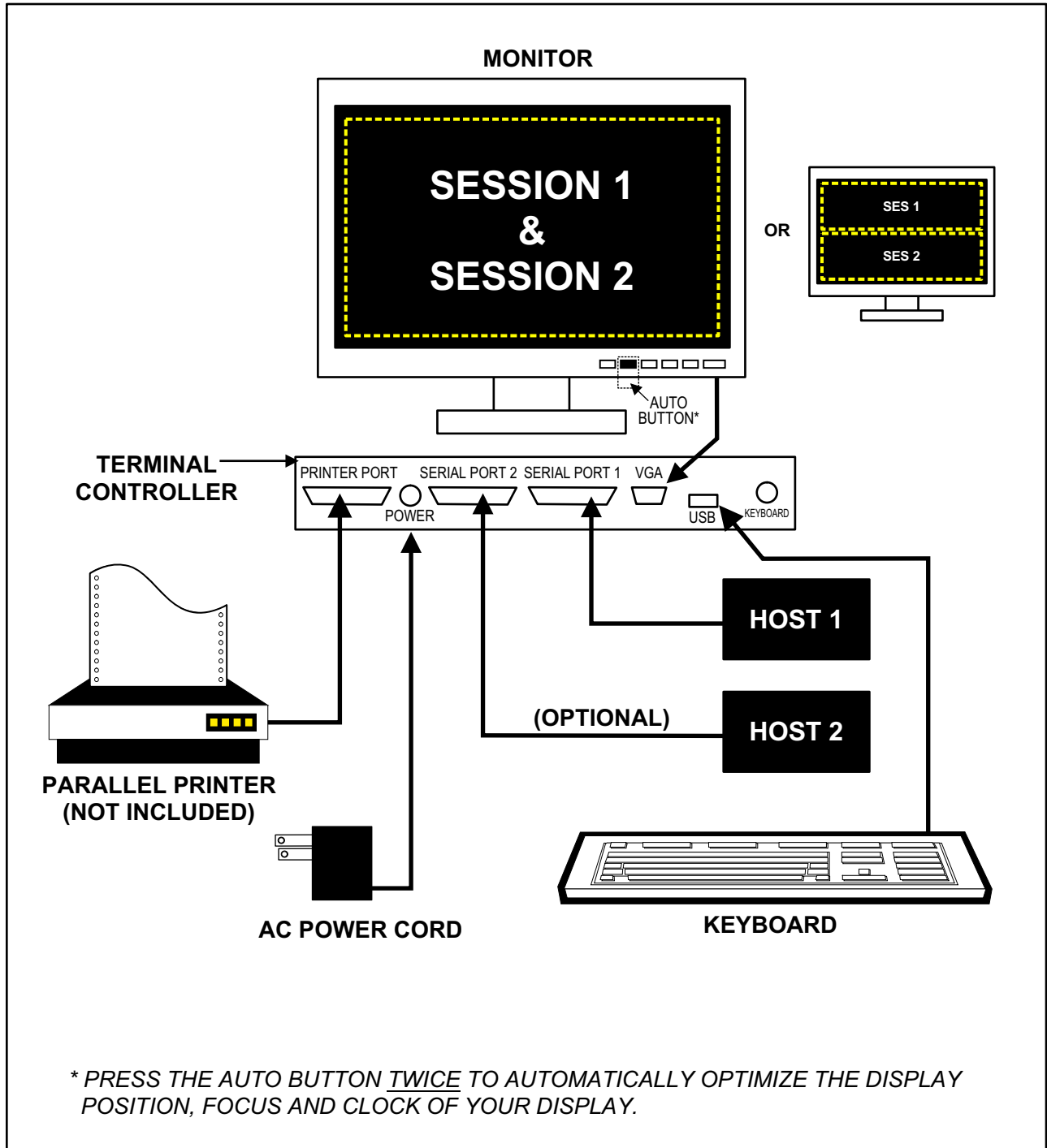



TT-DCAG5 Quick Guide

TERMINAL COMMAND KEYS

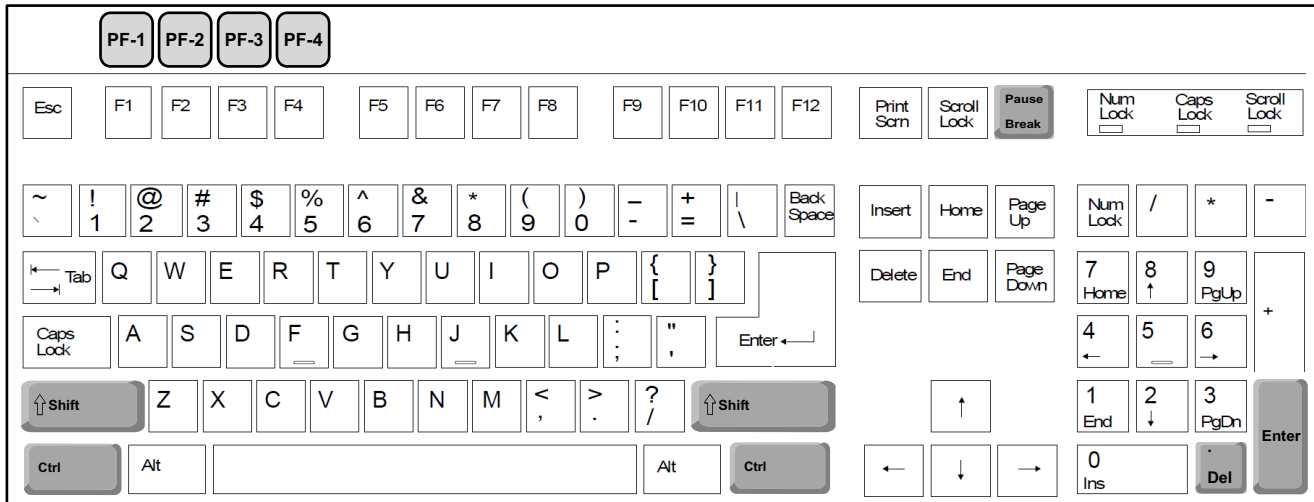
FIGURE 2

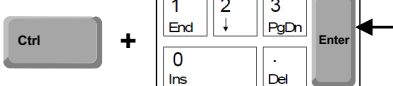
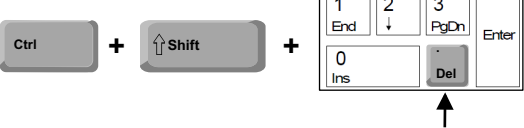

SWITCH SESSIONS (for dual sessions only)	<p>Press Ctrl + Enter (Enter on the Number Pad)</p> <div style="text-align: right; margin-top: 20px;">  </div>
PRINT	<p>Press Ctrl + Shift + . (Decimal on the Number Pad)</p> <div style="text-align: right; margin-top: 20px;">  </div>
SEND BREAK	<p>Press Ctrl + Pause/Break Key</p> <div style="text-align: right; margin-top: 20px;">  </div>

PF-1	The PF-1 key displays the ACDC Main Menu on the lower half of the ACDC terminal screen.
PF-2	The PF-2 key causes the system to accept the input characters.
PF-3	The PF-3 key cancels the current menu.
PF-4	The PF-4 key at both the local and remote ACDC terminal toggles control between terminals. If the terminal is inactive, the PF-4 key activates it; if it is active, pressing the PF-4 key deactivates it. Using this key overrides the remote transfer feature.

TT-DCAG5 Quick Guide

NUMERIC KEYPAD KEY FUNCTIONS

FIGURE 3

K0	Acknowledge Alarms
K1	Refresh Static Display
K2	Performance Monitor Display 2
K3	Performance Monitor Display 3
K4	Performance Monitor Display 4
K5	ACDC Configuration Menu
K6	Print This Help Panel
K7	Toggle IOM Mode
K8	Enter ScratchPad Mode
K9	Leave ScratchPad Mode

NOTE:

Some of the keys listed in FIGURE 3 are affected when a menu is in progress. PF2* and PF3* are valid only during menu processing, while PF1*, K5, K7, K8 and K9 are valid only when no menu is processing. The other keys - K0, K1, K2, K3, K4, K6 and PF4* are valid at all times.

**PF functions are on the previous page.*

TT-DCAG5 Quick Guide

GENERAL SETTINGS NOTE

Terminals are supplied pre-configured for your GTD 5 switch. Some local settings may need to be adjusted. Example: Baud Rate, Function Keys etc.

The following pages show how to make adjustments to the terminal when required.

TT-DCAG5 Quick Guide

TERMINAL SETUP

FIGURE 4

PARAMETERS →

CHOICES →

SESSION →

FIGURE 5

ENTER SETUP SCREEN	Press Ctrl + Scroll Lock
SELECT MENU	Press F1 - Prt Scn <small>(see pg. 10 for GTD 5 Default Setup)</small>
NAVIGATE PARAMETERS	Press the Arrow Keys
NAVIGATE CHOICES	Press Enter or Spacebar (moves forward)
	Press Shift + Enter (moves backward)
EXIT SETUP SCREEN	Press the Pause Key (when prompted to "Save all", press Y key to Save or N key to discard)

TT-DCAG5 Quick Guide

CHANGING THE SERIAL PORT SETTINGS

FIGURE 6A

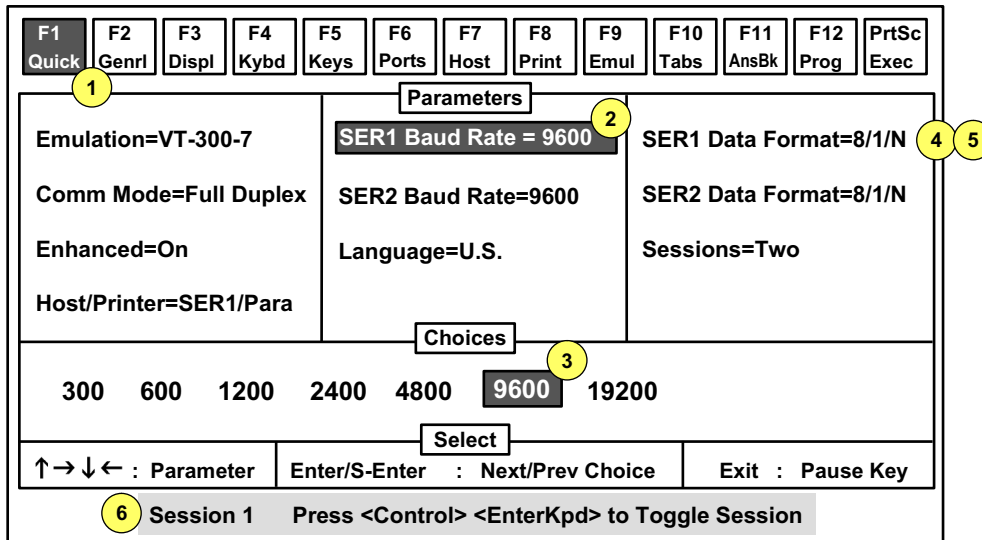

1. Press the **F1** button

FOR SESSION 1

2. Use the **Arrow Keys** to move to **SER1 Baud Rate (SER1 = Serial Port 1)**
3. Press **Enter** or **Spacebar** until the correct **Choice** is highlighted (9600 for GTD 5)
4. Use the **Arrow Keys** to move over to **SER1 Data Format**
5. Press **Enter** or **Spacebar** until the correct **Choice** is highlighted (8/1/N for GTD 5)
6. Press **<Control> <EnterKpd> to Toggle to Session 2** (see page 2 - "Switching Sessions")

FIGURE 6B

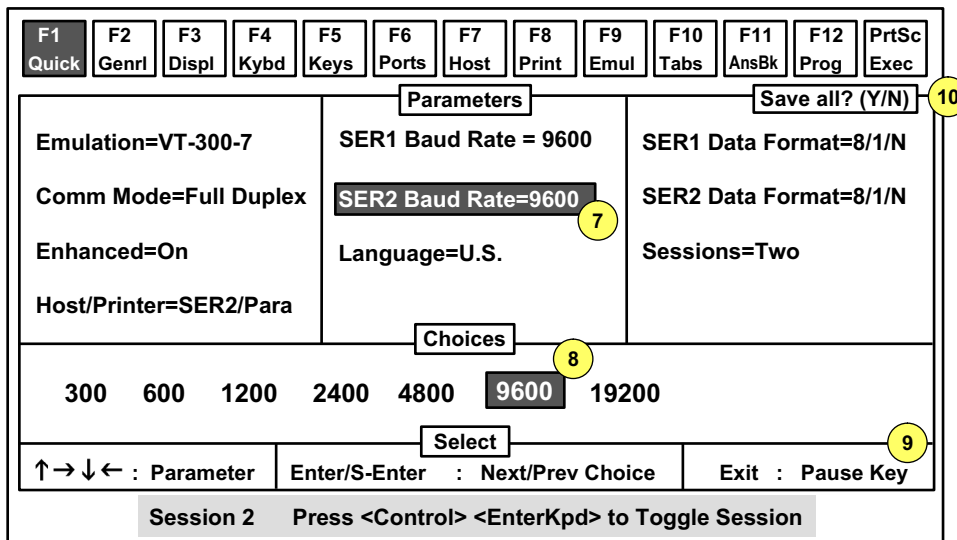

FOR SESSION 2

7. Use the **Arrow Keys** to move to **SER2 Baud Rate (SER2 = Serial Port 2)**
8. Press **Enter** or **Spacebar** until the correct **Choice** is highlighted (9600 for GTD 5)
9. When finished, press the **Pause Key** at the top right of the keyboard
10. When prompted with **"Save all?"**, click **Y** to save the new **Parameters**

TT-DCAG5 Quick Guide

CHANGING THE SCREEN DISPLAY TO FULL OR SPLIT SCREEN*

**Note: Applies to dual sessions only (see session setting in figures 6A & 6B).*

FIGURE 7

F1 Quick	F2 Genrl	F3 Displ	F4 Kybd	F5 Keys	F6 Ports	F7 Host	F8 Print	F9 Emul	F10 Tabs	F11 AnsBk	F12 Prog	PrtSc Exec
Parameters												
Emulation=VT-300-7 Screen Saver=5-min Warning Bell=On Host/Printer=SER1/Para				Enhanced=On Auto Page=Off Bell Length=350 ms Sessions=Two				Auto Wrap=Off Auto Scroll=On Bell Volume=5 Session Display=Full				
Choices												
Full				Split								
Select												
↑ → ↓ ← : Parameter				Enter/S-Enter : Next/Prev Choice				Exit : Pause Key				
Session 1 Press <Control> <EnterKpd> to Toggle Session												

1. Press the **F2** button
2. Use the **Arrow Keys** to move over to **Session Display**
3. Press **Enter** or **Spacebar** until the correct **Choice** is highlighted (Full / Split)

FIGURE 8

F1 Quick	F2 Genrl	F3 Displ	F4 Kybd	F5 Keys	F6 Ports	F7 Host	F8 Print	F9 Emul	F10 Tabs	F11 AnsBk	F12 Prog	PrtSc Exec
Parameters												Save all? (Y/N)
Page Length=24 Display Cursor=On Columns=80				Screen Length=26 Lines				Screen Video=Normal Auto Adjust Cursor=On Scroll Speed=Full				
Choices												
26 Lines				49 Lines								
Select												
↑ → ↓ ← : Parameter				Enter/S-Enter : Next/Prev Choice				Exit : Pause Key				
Session 1 Press <Control> <EnterKpd> to Toggle Session												

4. Press the **F3** button
5. Use the **Arrow Keys** to move over to **Screen Length**
6. Press **Enter** or **Spacebar** until the correct **Choice** is highlighted (26 Lines for Full Screen)
(49 Lines for Split Screen)
7. When finished, press the **Pause Key** at the top right of the keyboard
8. When prompted with "**Save all?**", click **Y** to save the new **Parameter**

TT-DCAG5 Quick Guide

PROGRAMMING FUNCTION KEYS*

*Each function key has (4) programmable registers per session such as **F/key**, **sh-F/key**, **ctrl-F/key** & **ctrl-sh-F/key** (These can be selected from the "Choices" located in the "Program" Parameter)

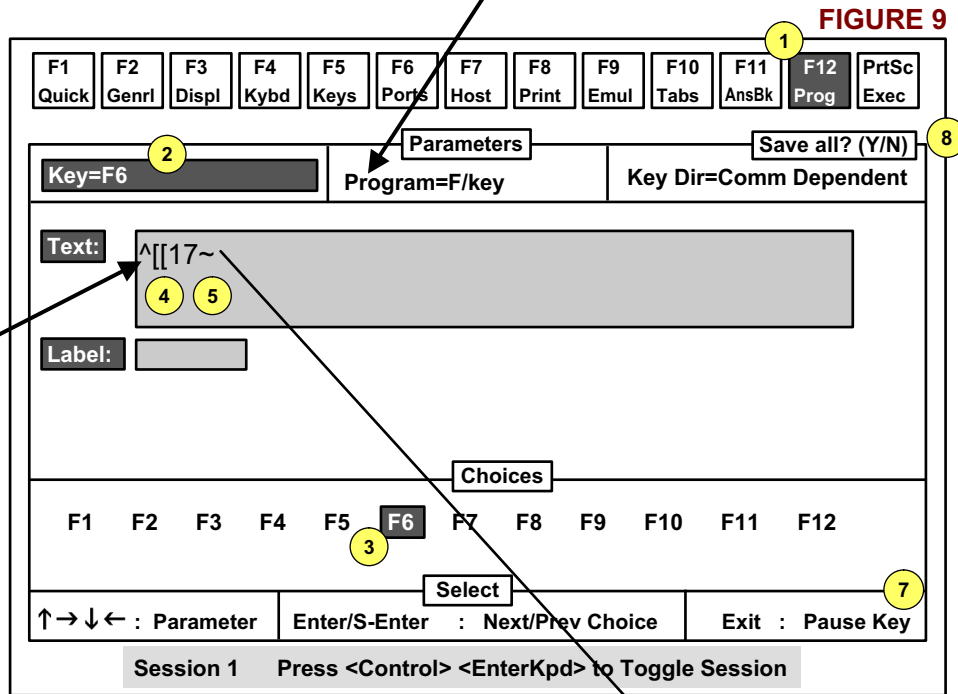
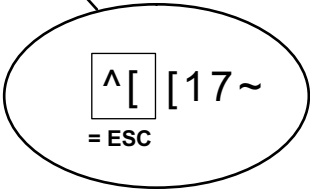

FIGURE 9

DO NOT LEAVE A SPACE HERE



Note:
For ^ press Shift+6

1. Press the **F12** button
2. The cursor will appear in the "Key" Field with F1 as the default (**DO NOT** change F1-F4)
3. Select a new function key to program by pressing **Enter** or **Spacebar** until the correct **Choice** is highlighted (for example choose F6)
4. Arrow down to move to the "Text" Field
5. Type in the "Function" for the key. **CAUTION:** The first character in the Text Field cannot be left blank

Example: To program **ESC[17~** Type: **Shift+6** **[[17** **Shift+`** = (**^[[17~**)

6. To program another function, arrow back up to the "Key" Field & repeat steps 3-5
7. When finished, press the **Pause Key** at the top right of the keyboard
8. When prompted with "Save all?", click **Y** to save the new **Parameter**

DO NOT CHANGE THE FUNCTIONS OF F1, F2, F3 & F4

TT-DCAG5 Quick Guide

CHANGING THE SCREEN TITLE

Note: This will change the title at the top of each Session.

FIGURE 10A

F1 Quick	F2 Genrl	F3 Displ	F4 Kybd	F5 Keys	F6 Ports	F7 Host	F8 Print	F9 Emul	F10 Tabs	F11 AnsBk	F12 Prog	PrtSc Exec
Parameters												
Answerback Mode=On				Answerback Conceal								
Answerback Message: /VT-100/												
Screen Title: TT-DCAG5 1_												
Choices												
<Backspace> : Delete Character <Shift><Backspace> : Default Field												
Select												
↑→↓← : Parameter				Enter/S-Enter : Next/Prev Choice				Exit : Pause Key				
4 Session 1 Press <Control> <EnterKpd> to Toggle Session												

DISPLAY ON MONITOR

1. Press the **F11** button
- FOR SESSION 1**
2. Use the **Arrow Keys** to move the cursor down to **Screen Title**
3. Type in a Title for Session 1 (Example: TT-DCAG5 1)
4. Press **<Control> <EnterKpd>** to Toggle to Session 2 (see page 2 - "Switching Sessions")

FIGURE 10B

F1 Quick	F2 Genrl	F3 Displ	F4 Kybd	F5 Keys	F6 Ports	F7 Host	F8 Print	F9 Emul	F10 Tabs	F11 AnsBk	F12 Prog	PrtSc Exec
Parameters												
Answerback Mode=On				Answerback Conceal								
Save all? (Y/N)												
Answerback Message: /VT-100/												
Screen Title: TT-DCAG5 2_												
Choices												
<Backspace> : Delete Character <Shift><Backspace> : Default Field												
Select												
↑→↓← : Parameter				Enter/S-Enter : Next/Prev Choice				Exit : Pause Key				
Session 2 Press <Control> <EnterKpd> to Toggle Session												

DISPLAY ON MONITOR

- FOR SESSION 2**
5. Use the **Arrow Keys** to move the cursor down to **Screen Title**
6. Type in a Title for Session 2 (Example: TT-DCAG5 2)
7. When finished, press the **Pause Key** at the top right of the keyboard
8. When prompted with "Save all?", click **Y** to save the new **Parameters**

TT-DCAG5 Quick Guide

GTD 5 DEFAULT SETTINGS*

***Note:** When using Dual Sessions, parameters must be set for both sessions.

Note: Items in **Bold** may require Local Settings.

FIGURE 11

Menu	Key	Parameters Available (Not all will display for a given emulation, keyboard, or video mode)		
Quick	F1	Emulation = VT-300-7 Comm Mode = Full Duplex Enhanced = On Host/Printer = SER1/Para SER2/Para	SER1 Baud Rate = 9600 SER2 Baud Rate = 9600 Language = U.S.	SER1 Data Format = 8/1/N SER2 Data Format = 8/1/N Sessions = Two
General	F2	Emulation = VT-300-7 Screen Saver = 5-min Warning Bell = On Host/Printer = SER1/Para SER2/Para	Enhanced = On Auto Page = Off Bell Length = 350 ms Sessions = Two	Auto Wrap = Off Auto Scroll = Off Bell Volume = 5 Session Display=Full
Display	F3	Page Length = 24 Display Cursor = On Columns = 80	Screen Length = 26 Lines Cursor = Blink Block Erase Color = Black	Screen Video = Normal Auto Adjust Cursor = On Scroll Speed = Full
Keyboard	F4	Language = U.S. Key Click = Off Num Lock = Toggle	Char Set Mode = ANSI Key Repeat = On Key Lock = Reverse	Margin Bell = Off Key Rate = 20 cps Caps Lock = Toggle
Keys	F5	Enter Key = <CR> Alt Key = Compose UDKS = Emul Dependent	Return Key = <CR> Disconnect = Pause	Backspace = <BS>/ Return Key Repeat = Off
Ports	F6	SER1 Baud Rate = 9600 SER2 Baud Rate = 9600 SER1 Xmt = Xon-Xoff SER2 Xmt = Xon-Xoff SER1 Break = 250 ms SER2 Break = 250 ms	SER1 Data Format = 8/1/N SER2 Data Format = 8/1/N SER1 Recv = Xon-Xoff(XPC) SER2 Recv = Xon-Xoff(XPC) SER1 Modem Control = Off SER2 Modem Control = Off	SER1 Parity Check = Off SER2 Parity Check = Off SER1 Xmt Pace = Baud SER2 Xmt Pace = Baud SER1 Disconnect = 2 sec SER2 Disconnect = 2 sec
Host	F7	Comm Mode = Full Duplex Recv = Ignore Send Region = Screen	Local = Off Null Suppress = On Send End = Region	Recv <CR> = <CR> Send Block Term = None
Print	F8	Prnt Mode = Normal	Prnt Region = Screen	Prnt Block = None
Emulation	F9	Numeric Kpd = Application ANSI-ID = VT320 Status Line = Indicator	Cursor Kpd = Application Feature Lock = Off	Send Data = All Function Key Lock = Off
Tabs	F10	Auto Init Tabs = Off	Default Tabs	
Answerback	F11	Answerback Mode = On Answerback Message: /VT-100/	Answerback Conceal	
Program	F12	Key = F6 Text: ^[[17~	Program = F/Key	Key Dir = Comm Dependent
Execute	Prt Sc	Save Terminal Save Session Reset Terminal Clear Screen Terminal Version	Recall Terminal Recall Session Reset Session Default Session UDKS	Default Terminal Default Session Reset Ports Update Terminal
Exit Setup	Pause	Save all? (Y/N)		

SER1 = SERIAL PORT 1

SER2 = SERIAL PORT 2