

AT&T C&E Test Tools / Kits

Hi-Cap / HDSL Acceptance Testing

REF: ATT-TELCO-620-000-230

KIT-RHPCR, AT&T PID # ATT.100035181

(1) # PHTUC-01
Portable "C" - HDSL Powering Test Unit

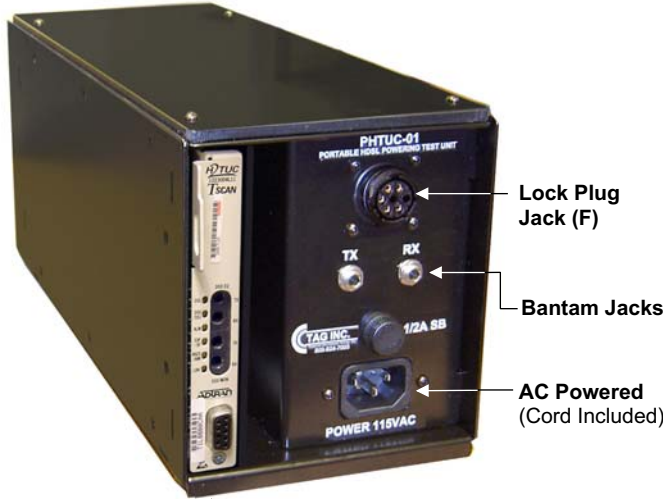

(card not included)

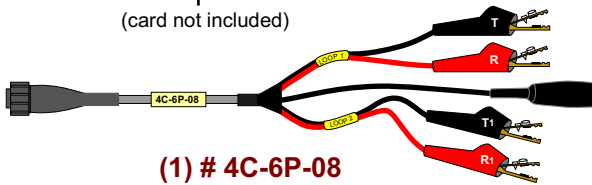

(1) # 4C-6P-08

Male Lock Plug to (4) 6P Alligator Clips w/ GND, (8')

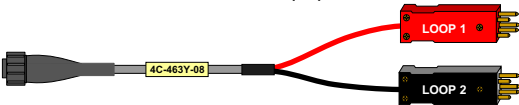

(1) # 4C-463Y-08

Male Lock Plug to 5 Pin "Y" Protector, (8')

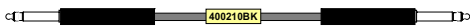

(1) # 400210BK

Bantam to Bantam Test Set Cord - Black, (6')

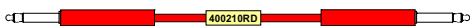

(1) # 400210RD

Bantam to Bantam Test Set Cord - Red, (6')

(1) # T-RHDSL
Portable "R" - HDSL Test Unit

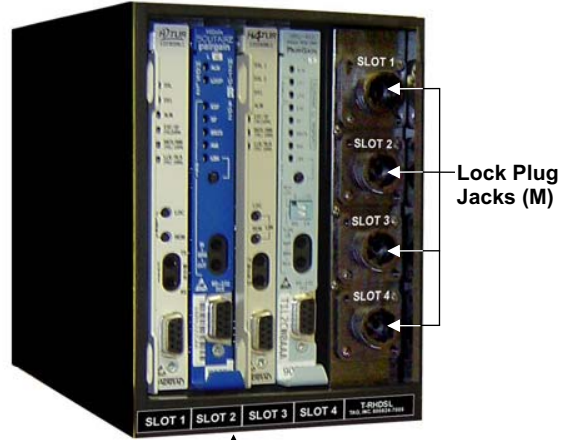

(cards not included)

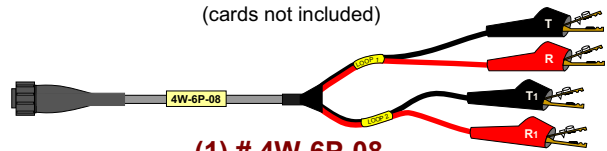

(1) # 4W-6P-08

Female Lock Plug to (4) 6P Alligator Clips, (8')

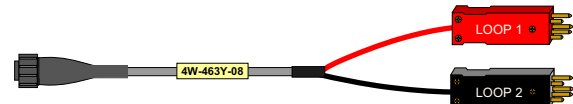

(1) # 4W-463Y-08

Female Lock Plug to 5 Pin "Y" Protector, (8')



Ordering Information:

KIT-RHPCR **Portable "C" HDSL Powering Unit & Portable "R" Unit Kit**
 includes: (1) PHTUC-01, (1) T-RHDSL, (1) 4C-6P-08,
 (1) 4C-463Y-08, (1) 400210RD, (1) 400210BK,
 (1) 4W-6P-08, (1) 4W-463Y-08 & (2) Carrying Cases

AT&T PID # (KIT)
ATT.100035181

150 Cooper Rd. (F-15)
 W. Berlin, NJ 08091

www.tagcords.com

Telephone: (856) 753-8585
 Fax : (856) 768-7645

Telecom Assistance Group

AT&T - "OSP T1 / HDSL Test Acceptance Tools" (Testing Diagram)

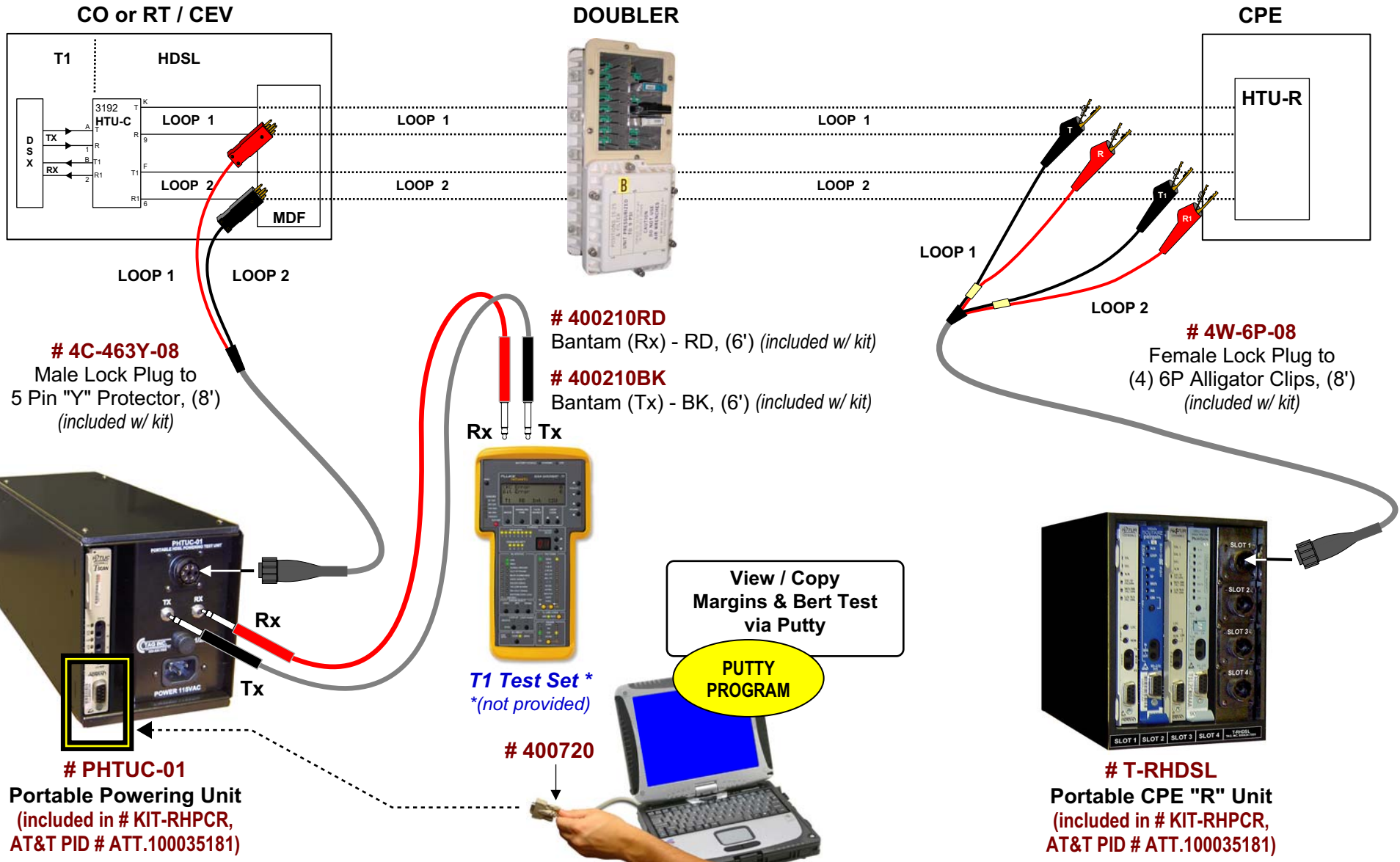

150 Cooper Rd. (F-15)
W. Berlin, NJ 08091

www.tagcords.com

Telecom Assistance Group

Telephone: (856) 753-8585

Fax : (856) 768-7645

AT&T - "OSP T1 / HDSL Test Acceptance Tools" (Testing Diagram)

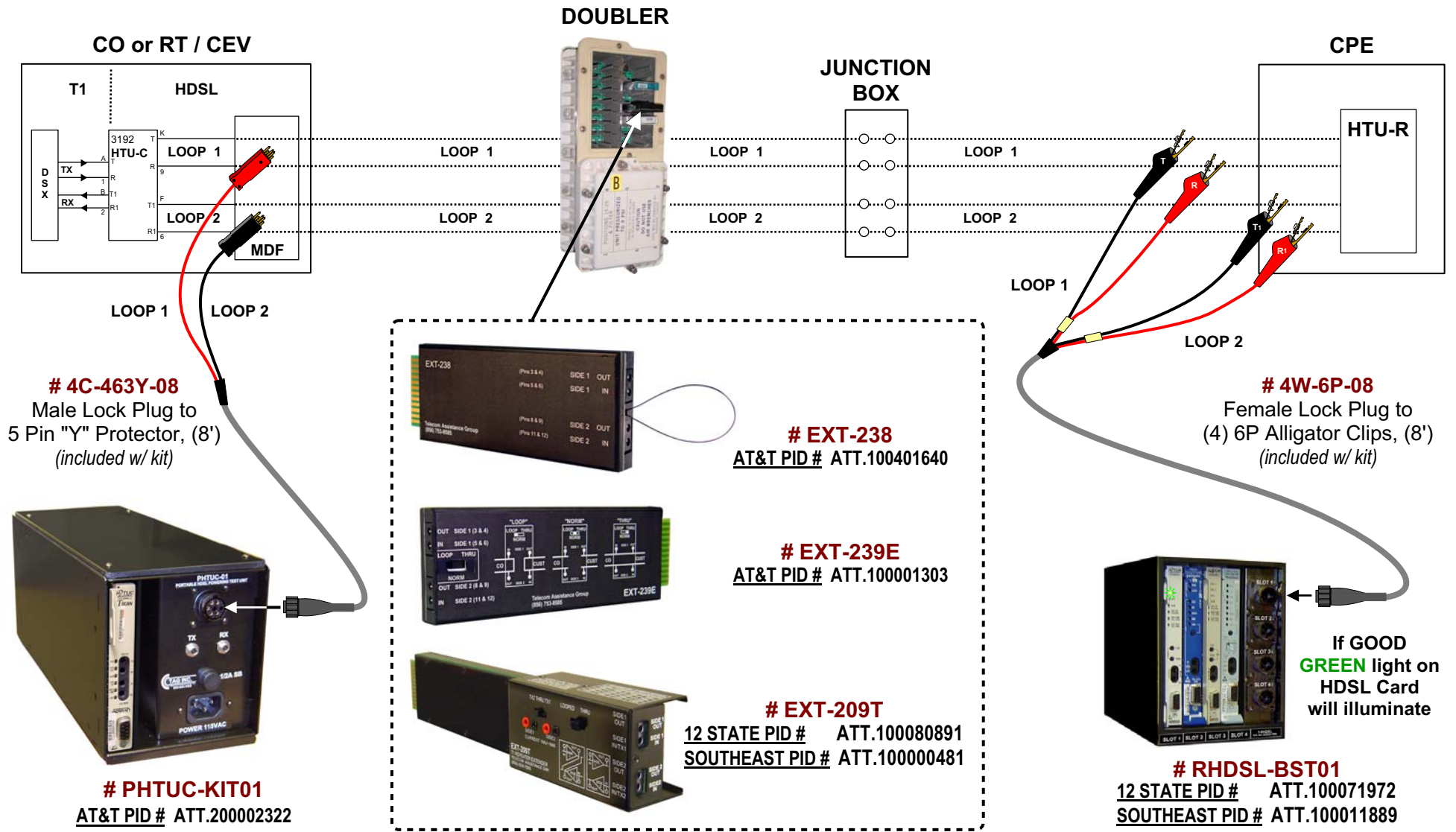

150 Cooper Rd. (F-15)
W. Berlin, NJ 08091

www.tagcords.com

Telecom Assistance Group

Telephone: (856) 753-8585
Fax : (856) 768-7645

AT&T - "OSP T1 / HDSL Test Acceptance Tools"

RHDSL-BST01 Portable "R" - HDSL Test Unit Kit

12 STATE (KIT)
ATT.100071972

SOUTHEAST (KIT)
ATT.100011889



(1) 600509
Carrying Case



(cards not included)

4W-6P-08 →

- ▶ **4 Slots for 200/400 Mech. HDSL "R" Cards**
- ▶ **Rugged Connectors**
- ▶ **Various Test Cords**

(1) 4W-6P-08
Female Lock Plug to
(4) 6P Alligator Clips, (8')

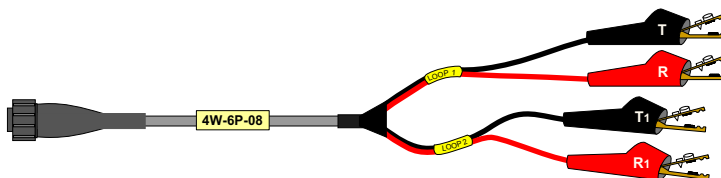

(1) 4W-463Y-08
Female Lock Plug to
5 Pin "Y" Protector, (8')

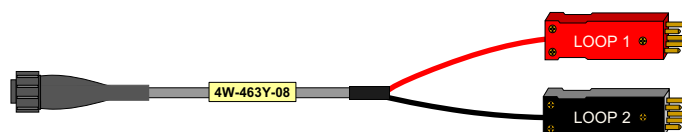

Ordering Information:

RHDSL-BST01 Portable "R" - HDSL Test Unit Kit
includes: (1) T-RHDSL, (1) 4W-6P-08,
(1) 4W-463Y-08 & (1) 600509

12 STATE (KIT)
ATT.100071972

SOUTHEAST (KIT)
ATT.100011889

T-RHDSL	Portable "R" HDSL Test Unit <i>(requires test cords)</i>	ATT.100071981	ATT.100011557
4W-463Y-08	Lock Plug (F) to 5 Pin "Y" Protector, (8')	ATT.100039928	ATT.100011859
4W-6P-08	Lock Plug (F) to (4) 6P Alligator Clips, (8')	AT&T PID #	
600509	Carrying Case	ATT.100022122	ATT.100001661

**** Cords are Required for Testing ****

150 Cooper Rd. (F-15)
W. Berlin, NJ 08091

www.tagcords.com

Telephone: (856) 753-8585
Fax : (856) 768-7645

Telecom Assistance Group

AT&T - "OSP T1 / HDSL Test Acceptance Tools"

20' - 4W Frame Cords for Portable "R" HDSL Test Unit

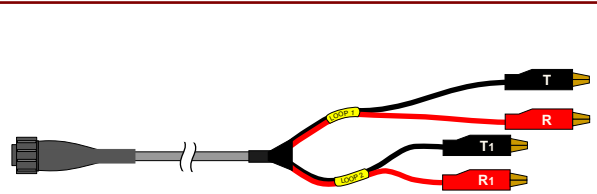

4W-A-20
Female Lock Plug to
(4) Std Alligator Clips, (20')

AT&T PID # ATT.100090481

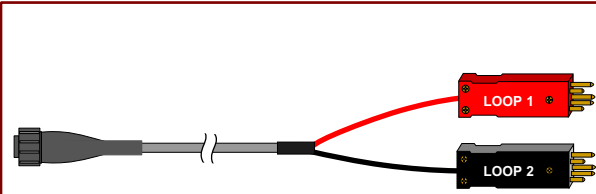

4W-463Y-20
Female Lock Plug to
Protector "Y", (20')

AT&T PID # ATT.100090482

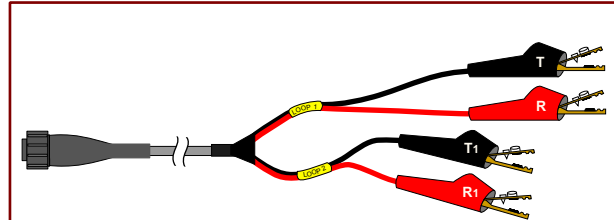

4W-6P-20
Female Lock Plug to
(4) 6P Alligator Clips, (20')

AT&T PID # ATT.100090483

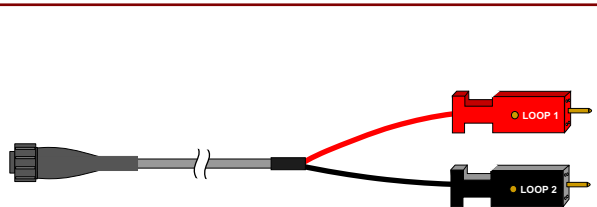

4W-PORTY-20
Female Lock Plug to
Porta "Y", (20')

AT&T PID # ATT.100090484

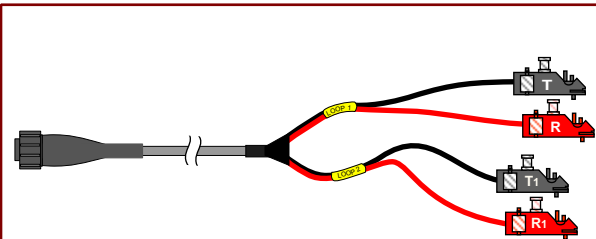

4W-252Y-20
Female Lock Plug to
252 "Y" Plugs, (20')

AT&T PID # ATT.100090485

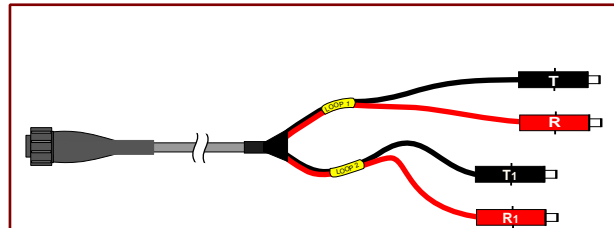

4W-412Y-20
Female Lock Plug to
412 "Y" Plugs, (20')

AT&T PID # ATT.100090486

- All Cords are available in other lengths -

AT&T - "OSP T1 / HDSL Test Acceptance Tools"

The Kit Includes: (1) # PHTUC-01
 Portable "C" -
 HDSL Powering Test Unit
 w/ AC Power Cord

PN # PHTUC-KIT01
 Portable "C" -
 HDSL Powering Test Unit Kit

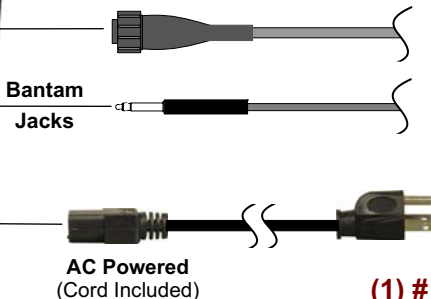

1 Slot (2 & 4 Wire)
 (3192 Mech. Card not included)

(1) # 600510
 Carrying Case
 AT&T PID # ATT.200002321
 (carrying case only)

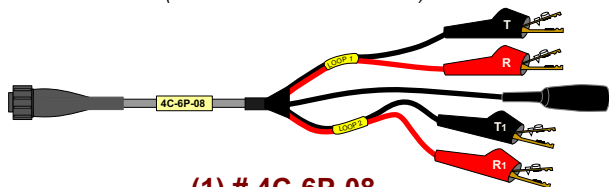

(1) # 4C-6P-08
 Male Lock Plug to (4) 6P Alligator Clips w/ GND, (8')
 AT&T PID # ATT.200002327 (cord only)

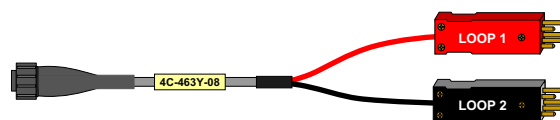

(1) # 4C-463Y-08
 Male Lock Plug to 5 Pin "Y" Protector, (8')
 AT&T PID # ATT.200002325 (cord only)



(1) # 400210BK
 Bantam to Bantam Test Cord - Black, (6')



(1) # 400210RD
 Bantam to Bantam Test Cord - Red, (6')

HDSL APPLICATION DIAGRAM

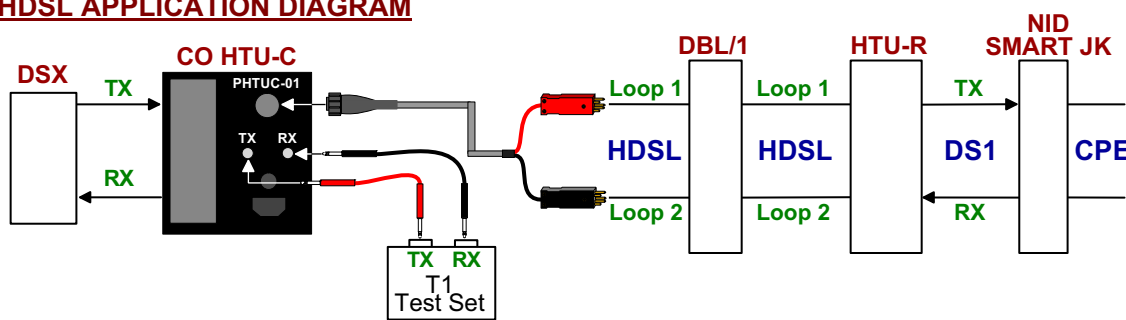

Ordering Information:

PHTUC-KIT01 Portable "C" - HDSL Powering Test Unit Kit
 includes: (1) PHTUC-01, (1) 4C-6P-08, (1) 4C-463Y-08,
 (1) 400210RD, (1) 400210BK & (1) 600510

AT&T PID # (KIT)
ATT.200002322

150 Cooper Rd. (F-15)
 W. Berlin, NJ 08091

www.tagcords.com

Telephone: (856) 753-8585
 Fax : (856) 768-7645

Telecom Assistance Group

AT&T - "OSP T1 / HDSL Test Acceptance Tools"

20' - 4C Frame Cords for Portable "C" HDSL Test Unit

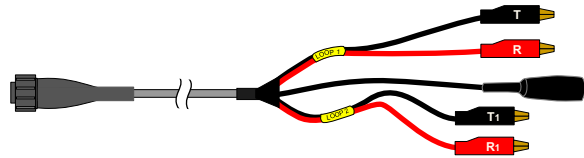

4C-A-20

Male Lock Plug to
(4) Std Alligator Clips w/ GND, (20')

AT&T PID # ATT.200002328

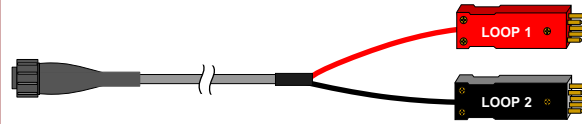

4C-463Y-20

Male Lock Plug to
Protector "Y", (20')

AT&T PID # ATT.200002330

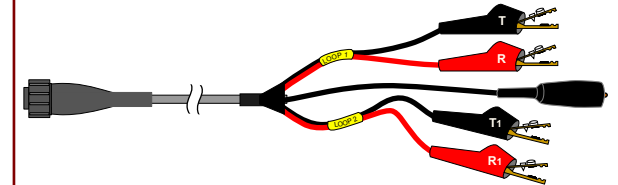

4C-6P-20

Male Lock Plug to
(4) 6P Alligator Clips w/ GND, (20')

AT&T PID # ATT.200002329

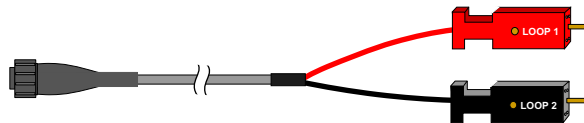

4C-PORTY-20

Male Lock Plug to
Porta "Y", (20')

AT&T PID # ATT.200002331

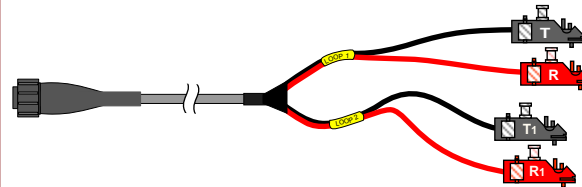

4C-252Y-20

Male Lock Plug to
252 "Y" Plugs, (20')

AT&T PID # ATT.200002332

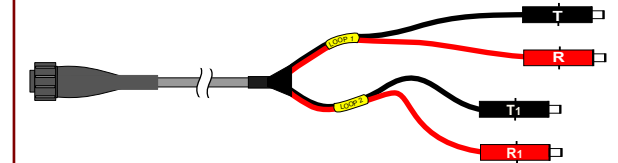

4C-412Y-20

Male Lock Plug to
412 "Y" Plugs, (20')

AT&T PID # ATT.200002333

- All Cords are available in other lengths -

150 Cooper Rd. (F-15)
W. Berlin, NJ 08091

www.tagcords.com

Telecom Assistance Group

Telephone: (856) 753-8585

Fax: (856) 768-7645

AT&T - "OSP T1 / HDSL Test Acceptance Tools"

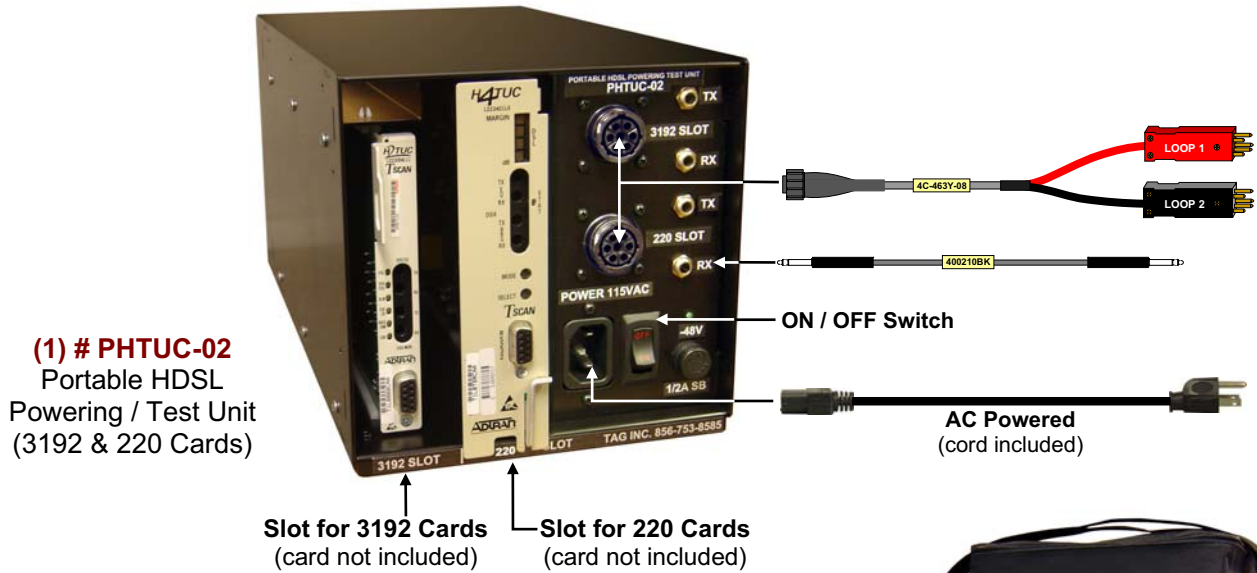

- ▶ 2 Slots (3192 & 220)
- ▶ Bantam Jacks for T1 Test Sets
- ▶ Isolates Troubles
- ▶ New Installs



(1) # 600510
 Carrying Case
AT&T PID # ATT.200002321
 (carrying case only)

Approx. Dimensions:
 14" (H) x 9" (L) x 7" (D)

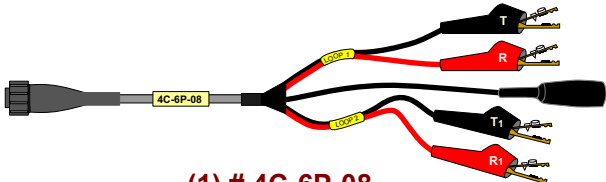

(1) # 4C-6P-08
 Male Lock Plug to (4) 6P Alligator Clips w/ GND, (8')
AT&T PID # ATT.200002327 (cord only)

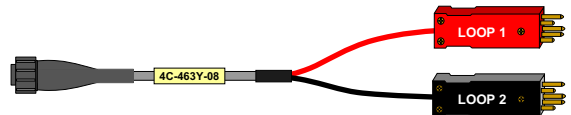

(1) # 4C-463Y-08
 Male Lock Plug to 5 Pin "Y" Protector, (8')
AT&T PID # ATT.200002325 (cord only)



(1) # 400210BK
 Bantam to Bantam Test Cord - Black, (6')



(1) # 400210RD
 Bantam to Bantam Test Cord - Red, (6')

Ordering Information:

PHTUC02-KIT01 Portable "C"- HDSL Test Unit Kit (3192 & 220)
 includes: (1) PHTUC-02, (1) 4C-463Y-08, (1) 4C-6P-08,
 (1) 400210RD, (1) 400210BK & (1) 600510 - Carrying Case

AT&T PID # (KIT)
ATT.100035182

150 Cooper Rd. (F-15)
 W. Berlin, NJ 08091

www.tagcords.com

Telecom Assistance Group

Telephone: (856) 753-8585
 Fax: (856) 768-7645

AT&T - "OSP T1 / HDSL Test Acceptance Tools"

The EXT-238K3 Kit is designed for technicians who test at T1 Line Repeater Housings, such as 818 apparatus cases. (see Fig. 1) The Kit Includes:

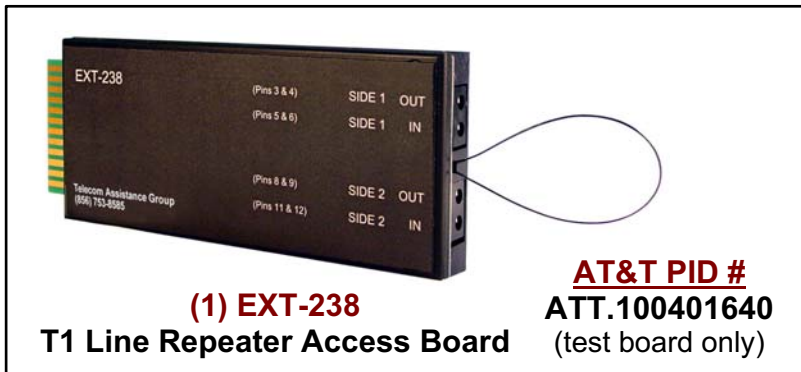
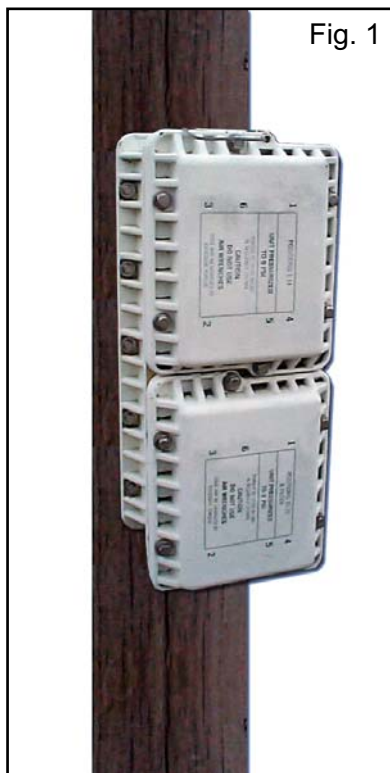

(1) 400210RD-03
Bantam to Bantam - Red, (3')



(1) 400210ARD-03
Bantam to Alligator Clips - Red, (3')



(1) 400210BK-03
Bantam to Bantam - Black, (3')



(1) 400210ABK-03
Bantam to Alligator Clips - Black, (3')

Ordering Information:

EXT-238K3

T1 Repeater Access Kit

includes: (1) EXT-238, (1) 400210RD-03,
(1) 400210BK-03, (1) 400210ARD-03,
(1) 400210ABK-03 & (1) 600209 - carrying case

AT&T PID # (KIT)

ATT.100001313

150 Cooper Rd. (F-15)
W. Berlin, NJ 08091

www.tagcords.com

Telephone: (856) 753-8585
Fax : (856) 768-7645

Telecom Assistance Group

AT&T - "OSP T1 / HDSL Test Acceptance Tools"

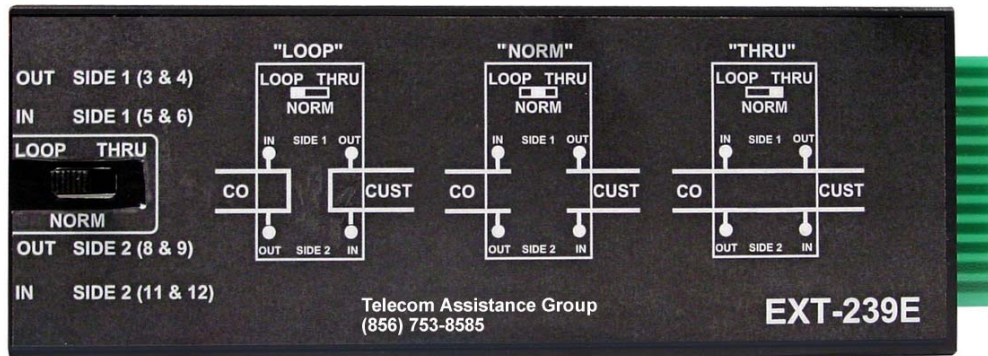

EXT-239E

Plugs into T1, 56KB, HDSL, ISDN Apparatus Cases

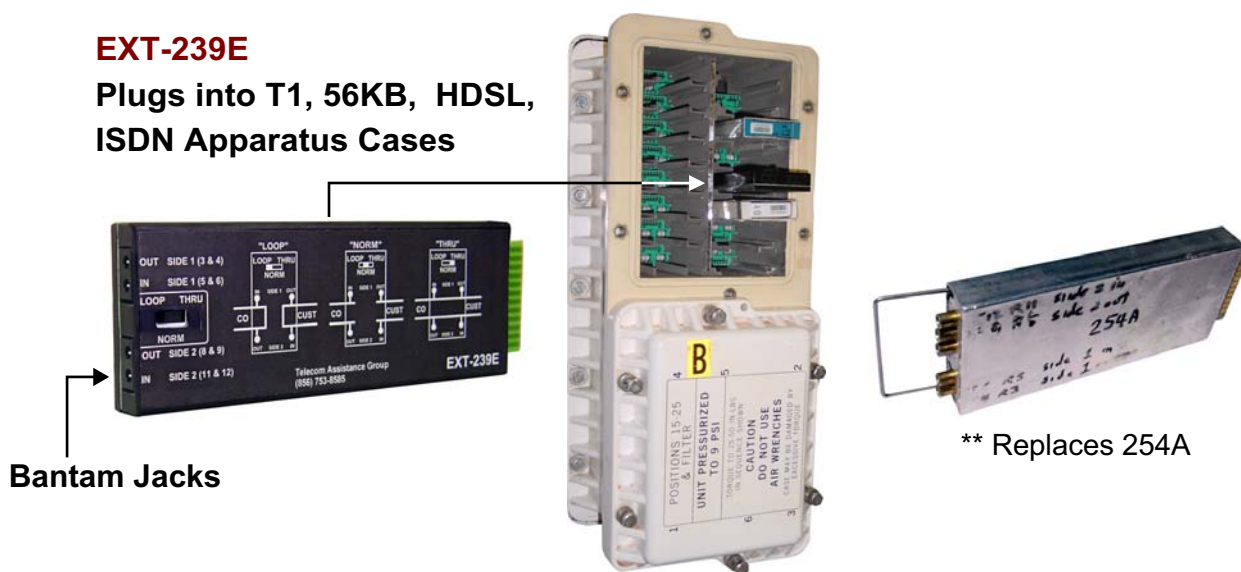

Bantam Jacks

Features:

- Enhanced switch settings for Thru, Norm, and Loop testing at T1 line repeater apparatus cases
- Metallic access at T1 line repeater slots
- Use with test sets to perform Cable Loss, Resistance, or TDR test set to locate load coils

Ordering Information:

EXT-239E

T1 Wiring Access Board

AT&T PID

ATT.100001303

400210A

Bantam to Alligator Clips, (6')

12 STATE

ATT.100038299

SOUTHEAST

ATT.100000681

600100C

Test Board Carrying Case

ATT.100038527

ATT.100001273

150 Cooper Rd. (F-15)
W. Berlin, NJ 08091

www.tagcords.com

Telephone: (856) 753-8585
Fax: (856) 768-7645

Telecom Assistance Group

AT&T - "OSP T1 / HDSL Test Acceptance Tools"

Ordering Information:

Part # EXT-209B

12 STATE SOUTHEAST
ATT.100070054 ATT.100001207

Description: T1 Loopback Extender

- Universal interface to all test sets
- Loops signal and simplex current
- Isolates trouble to repeater or cable
- Bantam Jack access eliminates special probes and cables
- Direct metallic bridging allows current, voltage and loop resistance measurements



Part # EXT-209T

12 STATE SOUTHEAST
ATT.100080891 ATT.100000481

Description: T1 Repeater Extender

- Span current test points
- Loops signal and simplex current
- Test repeaters in the field
- Bantam Jack access to monitor/transmit QRSS, 3 in 24 from test sets
- Direct metallic bridging allows current, voltage and loop resistance measurements



Part # 600100C

12 STATE SOUTHEAST
ATT.100038527 ATT.100001273

Description: Test Board Carrying Case



150 Cooper Rd. (F-15)
W. Berlin, NJ 08091

www.tagcords.com

Telecom Assistance Group

Telephone: (856) 753-8585
Fax : (856) 768-7645

AT&T - "OSP T1 / HDSL Test Acceptance Tools"

**Kit Designed for
CopperPro* Test Set &
Far End Device**



****Fluke TN2100
& CopperPro
not included****



**INCLUDES
CARRYING
CASE**

8 Pouch Carrying Case
Part # TCC-001

**12 STATE
ATT.100071979**

**SOUTHEAST
ATT.100001659**

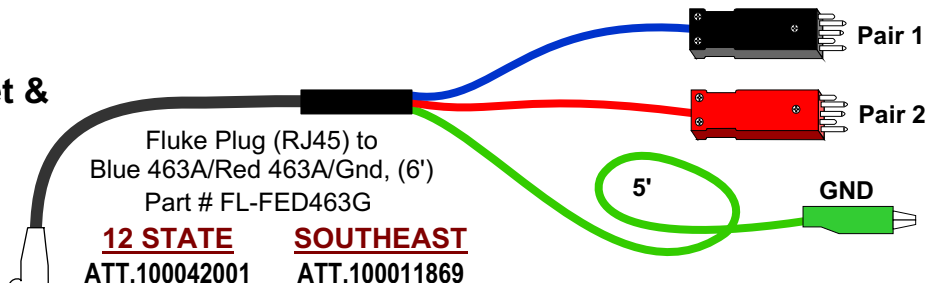

<p>Fluke to 463A Protector (Blue), (6') Part # FL-400100SBY</p> <p>12 STATE: ATT.100041997 SOUTHEAST: ATT.100011855</p>
<p>Fluke to 463A Protector (Red), (6') Part # FL-400100SRD</p> <p>12 STATE: ATT.100041998 SOUTHEAST: ATT.100011857</p>
<p>Fluke to Wire Wraps (Blue), (6') Part # FL-400100WPBY</p> <p>12 STATE: ATT.100040056 SOUTHEAST: ATT.100011845</p>
<p>Fluke to Wire Wraps (Red), (6') Part # FL-400100WPRD</p> <p>12 STATE: ATT.100041999 SOUTHEAST: ATT.100011847</p>
<p>Fluke to Bantam (Blue), (6') Part # FL-400100BBY</p> <p>12 STATE: ATT.100041996 SOUTHEAST: ATT.100011849</p>
<p>Fluke to Bantam (Red), (6') Part # FL-400100BRD</p> <p>12 STATE: ATT.100041995 SOUTHEAST: ATT.100011851</p>
<p>Ground Cord, (8') Part # FL-400409</p> <p>12 STATE: ATT.100042000 SOUTHEAST: ATT.100011811</p>

Ordering Information:

KIT-CP990-BST Fluke CopperPro 990* Cord Kit

includes: (1) FL-FED463G, (1) FL-400100SBY, (1) FL-400100SRD,
(1) FL-400100WPBY, (1) FL-400100WPRD, (1) FL-400100BBY,
(1) FL-400100BRD, (1) FL-400409 & (1) TCC-001

**12 STATE (KIT)
ATT.100071967**

**SOUTHEAST (KIT)
ATT.100011835**

150 Cooper Rd. (F-15)
W. Berlin, NJ 08091

www.tagcords.com

Telecom Assistance Group

Telephone: (856) 753-8585
Fax : (856) 768-7645

AT&T - "OSP T1 / HDSL Test Acceptance Tools"

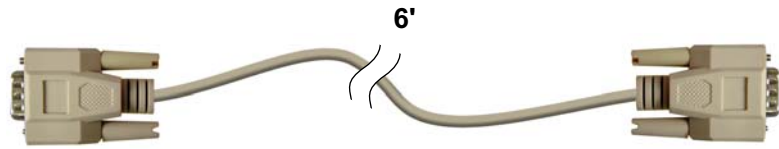

PN # 400720
DB9 Pin (male) to DB9 Pin (female), (6')

12 STATE **SOUTHEAST**
ATT.100041957 ATT.100000571

```
Adtran HDSL2 Main Menu
1. HDSL2 Unit Information
2. Provisioning
3. Span Status
4. Loopbacks and Test
5. Performance History
6. Scratch Pad, Ckt ID, Time/Date
7. Terminal Modes
8. Alarm History
9. Event History
10. System PM/Screen Report
11. Clear PM and Alarm Histories
12. Troubleshooting
13. Virtual Terminal Control
```



9 Pin connector on HDSL ckt



• Commonly used from Laptop to test at Pair Gain (HDSL) • Wired straight

Ordering Information:

400720 **DB9 Pin (male) to DB9 Pin (female), (6')**

400720USB* **DB9 Pin (male) / RS232 to USB Adapter Cable, (6')**
Supports Windows® 2000 / XP / Server 2008 / Vista / 7 / 8 / 10, Linux, Mac os V8.6 or higher
** (for laptops that don't have a serial port)*

12 STATE **SOUTHEAST**
ATT.100041957 ATT.100000571

AT&T PID #
ATT.100000993

150 Cooper Rd. (F-15)
W. Berlin, NJ 08091

www.tagcords.com
Telecom Assistance Group

Telephone: (856) 753-8585
Fax: (856) 768-7645

AT&T - "OSP T1 / HDSL Test Acceptance Tools"



**KIT
INCLUDES
CARRYING
CASE**

(1) 8 Pouch Carrying Case
TCC-001

TFS Cord Kit

(for Test Sets w/ Bantam Jacks)

(1) Bantam to Alligator Clips (8') Red, # 400210ARD-08
(1) Bantam to Alligator Clips (8') Black, # 400210ABK-08

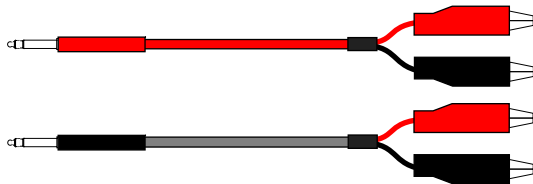

(1) Bantam to Wire Wraps (8') Red, # 400210WPR-08
(1) Bantam to Wire Wraps (8') Black, # 400210WPB-08

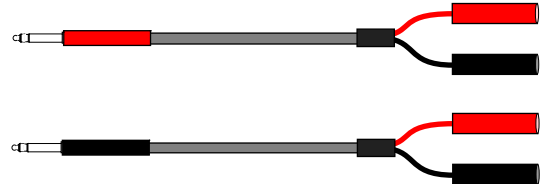

(1) RJ48 to RJ48 (T1), (6')
400448



(1) Bantam "Y" to RJ48S (DDS), (8')
400248SY



(1) Bantam to Bantam (8') Red, # 400210RD-08
(1) Bantam to Bantam (8') Black, # 400210BK-08



(1) Bantam "Y" to RJ48 (T1), (8')
400248Y



(1) Bantam to 310 (8'), Red
400310MRD-08



(1) Bantam to 310 (8'), Black
400310MBK-08



Ordering Information:

KIT-BANT TFS Cord Kit

includes: (1) 400210ARD-08, (1) 400210ABK-08, (1) 400210WPR-08,
(1) 400210WPB-08, (1) 400448, (1) 400248SY, (1) 400248Y, (1) 400210RD-08,
(1) 400210BK-08, (1) 400310MRD-08, (1) 400310MBK-08 & (1) TCC-001

12 STATE **SOUTHEAST**
ATT.100071966 ATT.100000967

150 Cooper Rd. (F-15)
W. Berlin, NJ 08091

www.tagcords.com

Telephone: (856) 753-8585
Fax : (856) 768-7645

Telecom Assistance Group

AT&T - "OSP T1 / HDSL Test Acceptance Tools"



400300S

Protector (non-bridging) to Alligator Clips, (8')

AT&T PID # ATT.100001291



400300SP-03

Porta (non-bridging) to Alligator Clips, (3')

AT&T PID # ATT.100001293



400526A

526A Plug to Alligator Clips, (6')

12 STATE # ATT.100035489

SOUTHEAST # ATT.100001789



400210ARD

Bantam to Alligator Clips - Red, (6')



400210ABK

Bantam to Alligator Clips - Black, (6')



400210A

Bantam to Alligator Clips, (6')

12 STATE # ATT.100038299

SOUTHEAST # ATT.100000681



400210RD

Bantam to Bantam - Red, (6')

AT&T PID # ATT.100068132



400210BK

Bantam to Bantam - Black, (6')

AT&T PID # ATT.100408970

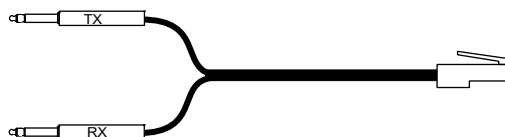

400248-08

Bantam "Y" (Tx & Rx) to RJ48C- (T1), (8')

AT&T PID # ATT.100000707

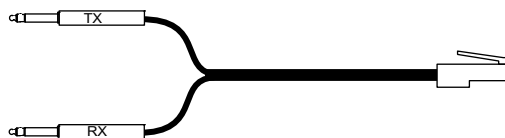

400248S

Bantam "Y" (Tx & Rx) to RJ48S - (DDS), (8')

AT&T PID # ATT.100000735

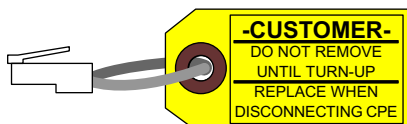

400448LP

Temporary RJ48 Looping Plug

AT&T PID # ATT.100000561

150 Cooper Rd. (F-15)
W. Berlin, NJ 08091

www.tagcords.com

Telecom Assistance Group

Telephone: (856) 753-8585

Fax : (856) 768-7645

AT&T - "OSP T1 / HDSL Test Acceptance Tools"



TB-86B

"DDM Plus" Office Repeater
Test Board w/ Bantam Jacks

12 STATE **SOUTHEAST**
ATT.100071977 ATT.100012819



TB-3192B

3190/3192 Office Repeater
Test Board w/ Bantam Jacks

12 STATE **SOUTHEAST**
ATT.100069270 ATT.100000553



TB-231B

220 (Kentrox size) Office Repeater
Test Board w/ Bantam Jacks

12 STATE **SOUTHEAST**
ATT.100071973 ATT.100001307



TB-TA3000-ORB

Adtran Total Access 3000 Test Board
w/ Bantam Jacks

12 STATE **SOUTHEAST**
ATT.100070282 ATT.100001305



TB-400B

HDSL Remote HRU-200/400
Mechanics w/ Bantam Jacks

12 STATE **SOUTHEAST**
ATT.100071975 ATT.100001301



EXT-239E

T1 Line Repeater Access Board
w/ Bantam Jacks

AT&T PID #
ATT.100001303

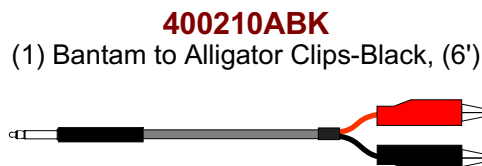
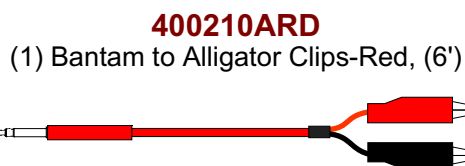

600209N
Carrying Case
AT&T PID #
ATT.100001277

Ordering Information:

KIT-TBORB-B02 ORB Test Kit

includes: (1) TB-86B, (1) TB-231B, (1) TB-3192B,
(1) TB-400B, (1) TB-TA3000-ORB, (1) EXT-239E,
(1) 400210ARD, (1) 400210ABK & (1) 600209N - carrying case

12 STATE (KIT)
ATT.100071970

SOUTHEAST (KIT)
ATT.100011891

150 Cooper Rd. (F-15)
W. Berlin, NJ 08091

www.tagcords.com

Telephone: (856) 753-8585
Fax : (856) 768-7645

Telecom Assistance Group

AT&T - "OSP T1 / HDSL Test Acceptance Tools"



TB-86B

"DDM Plus" Office Repeater
Test Board w/ Bantam Jacks

12 STATE
ATT.100071977

SOUTHEAST
ATT.100012819

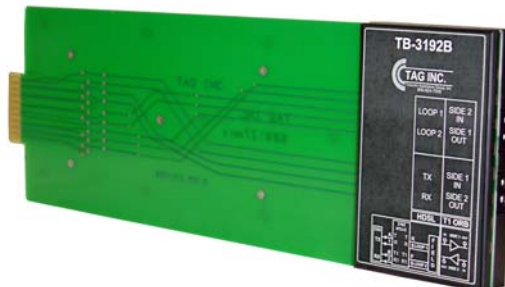

TB-3192B

3190/3192 Office Repeater
Test Board w/ Bantam Jacks

12 STATE
ATT.100069270

SOUTHEAST
ATT.100000553



TB-231B

220 (Kentrox size) Office Repeater
Test Board w/ Bantam Jacks

12 STATE
ATT.100071973

SOUTHEAST
ATT.100001307



TB-400B

HDSL Remote HRU-200/400
Mechanics w/ Bantam Jacks

12 STATE
ATT.100071975

SOUTHEAST
ATT.100001301



EXT-239E

T1 Line Repeater Access Board
w/ Bantam Jacks

AT&T PID #
ATT.100001303

400210ARD

(1) Bantam to Alligator Clips-Red, (6')



400210ABK

(1) Bantam to Alligator Clips-Black, (6')



600209N

Carrying Case

AT&T PID #
ATT.100001277

Ordering Information:

KIT-TBORB-B

ORB Test Kit

includes: (1) TB-86B, (1) TB-231B, (1) TB-3192B,
(1) TB-400B, (1) EXT-239E, (1) 400210ARD,
(1) 400210ABK & (1) 600209N - carrying case

12 STATE (KIT)
ATT.100071969

SOUTHEAST (KIT)
ATT.100001199

150 Cooper Rd. (F-15)
W. Berlin, NJ 08091

www.tagcords.com

Telecom Assistance Group

Telephone: (856) 753-8585

Fax : (856) 768-7645