





# Frontier Patch Cords

FEATURES / APPLICATION	FTR UPN #	DESCRIPTION
<p>Bantam to Bantam - Black, (3')                      Bantam to Bantam, (6')                      Bantam to Bantam - Black, (8')                      Bantam to Bantam - Red, (8')                      Bantam to Bantam, (20')</p> <ul style="list-style-type: none"> <li>• General purpose test / patch cord</li> </ul>	<p>400210BK-03                      400210                      400210BK-08                      400210RD-08                      400210-20</p>	<p>BANTAM to BANTAM</p> 
<p>Dual Bantam to Dual Bantam, (25')                      Dual Bantam to Dual Bantam, (30')</p> <ul style="list-style-type: none"> <li>• General purpose test / patch cord</li> </ul>	<p>400210DD-25                      400210DD-30</p>	<p>DUAL BANTAM to DUAL BANTAM</p> 
<p>310 to 310, (6')</p> <ul style="list-style-type: none"> <li>• General purpose test / patch cord</li> </ul>	<p>400310</p>	<p>310 to 310</p> 
<p>Bantam to 310 Conversion Plug                      Bantam to 310 Conversion Plug, Red</p> <ul style="list-style-type: none"> <li>• Slides over bantam plug converting it to a 310</li> </ul>	<p>400239BST                      400239RD</p>	<p>BANTAM TO 310 CONVERSION PLUG</p>  <p>BANTAM # 400239BST                      # 400239RD (RED)</p>
<p>310 (female) to Bantam Conversion Cord, (12")</p> <ul style="list-style-type: none"> <li>• 310 Plugs into adapter converting to bantam</li> </ul>	<p>400238-12</p>	<p>310 to BANTAM CONVERSION CORD</p>  <p>310 # 400238-12</p>
<p>Bantam Terminating Plug                      310 Terminating Plug</p> <ul style="list-style-type: none"> <li>• 100 ohm</li> </ul>  <p># 400210TP-1</p>  <p># 400310TP-1</p>	<p>Bantam Looping Plug</p> <ul style="list-style-type: none"> <li>• 3 conductor looping plug</li> </ul> 	<p>310 Looping Plug</p> <ul style="list-style-type: none"> <li>• 3 conductor looping plug</li> </ul> 

# DSX-1

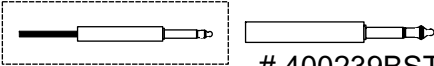
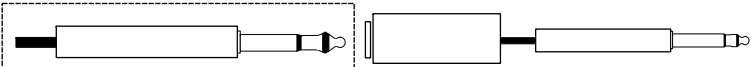
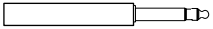
# Color Coded Patch / Test Cords

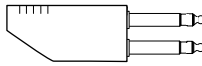
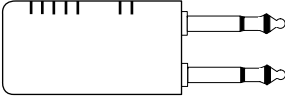
## Bantam to Bantam

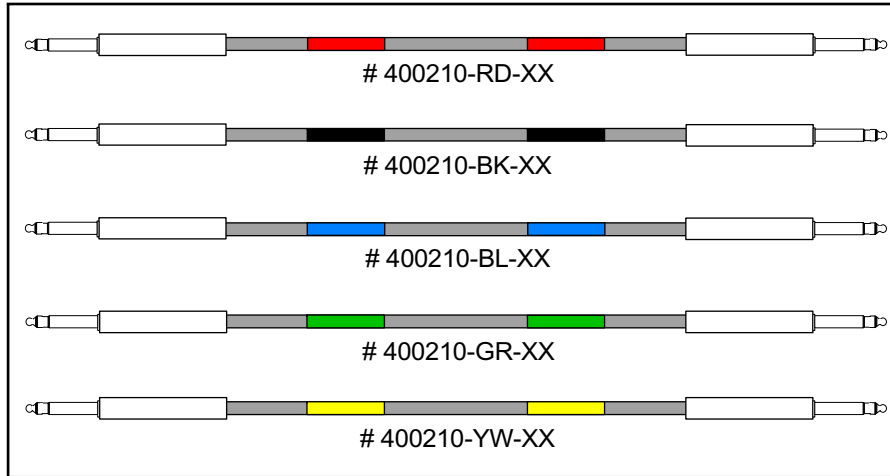

## 310 to 310

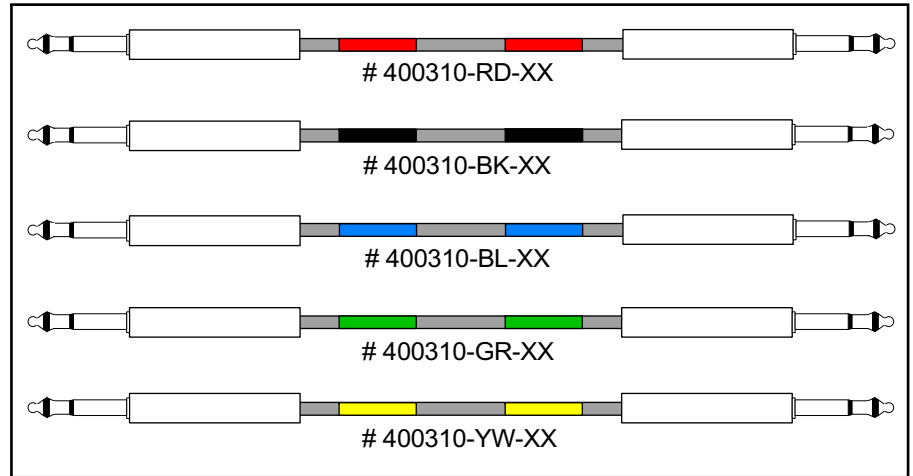

## Dual Bantam to Dual Bantam

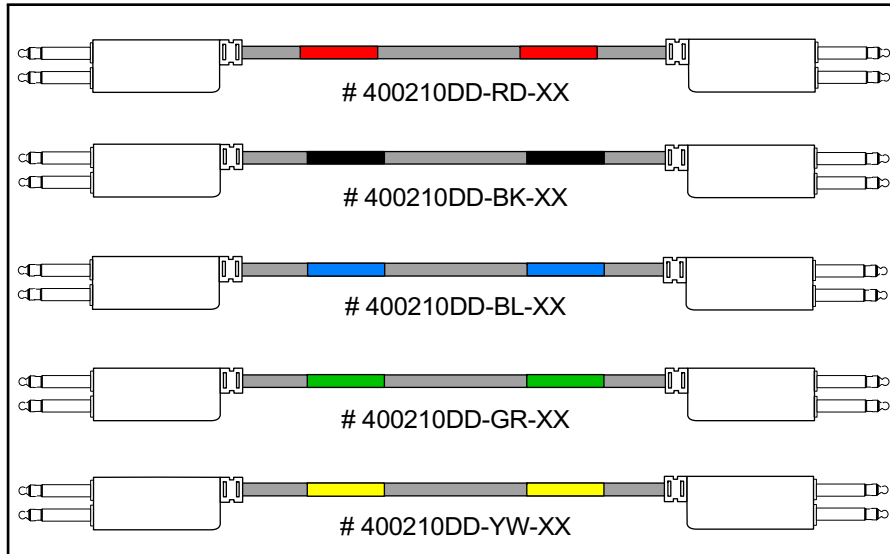

## Dual 310 to Dual 310

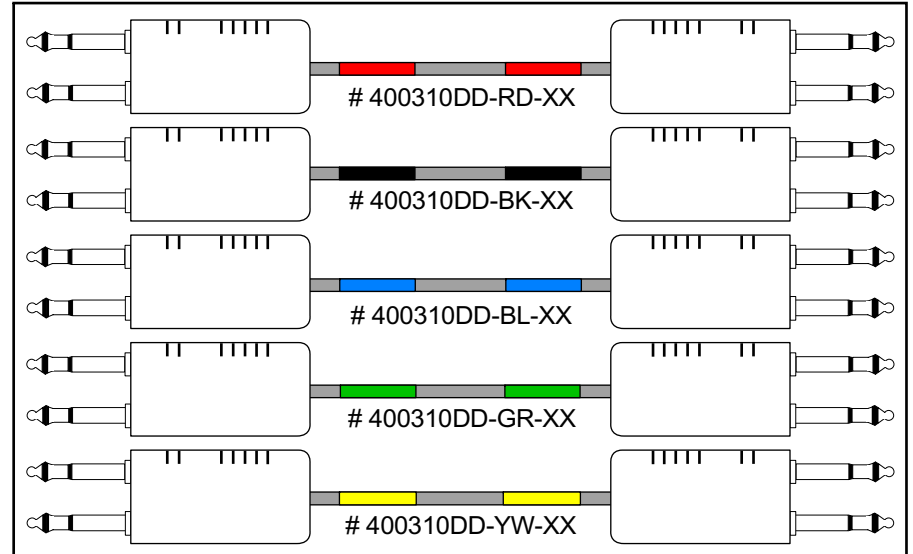

\* XX represents the numeric digits that correspond with the **desired length** of cord. Cords available in **ANY** length.

**EXAMPLE:** # 400210-BL-06 (Bantam to Bantam **BLUE 6'** long)

150 Cooper Rd. (F-15)  
W. Berlin, NJ 08091

[www.tagcords.com](http://www.tagcords.com)

**Telecom Assistance Group**

Telephone: (856) 753-8585

Fax: (856) 768-7645