













# Verizon Patch Cords

FEATURES / APPLICATION	PART #	VZ ID #	DESCRIPTION
<b>Bantam to Bantam - Red, (6')</b> <b>Bantam to Bantam - Red, (3')</b> <b>Bantam to Bantam - Red, (8')</b> <b>Bantam to Bantam - Red, (13')</b> <ul style="list-style-type: none"> <li>• General purpose test / patch cord</li> </ul>	<b>400210RD</b> <b>400210RD-03</b> <b>400210RD-08</b> <b>400210RD-13</b>	<b>1104 3640</b> <b>1100 7946</b> <b>1100 7947</b> <b>1125 8962</b>	<b>BANTAM to BANTAM - RED</b> 
<b>Bantam to Bantam - Black, (6')</b> <b>Bantam to Bantam - Black, (3')</b> <b>Bantam to Bantam - Black, (8')</b> <b>Bantam to Bantam - Black, (13')</b> <ul style="list-style-type: none"> <li>• General purpose test / patch cord</li> </ul>	<b>400210BK</b> <b>400210BK-03</b> <b>400210BK-08</b> <b>400210BK-13</b>	<b>1104 3639</b> <b>1100 7943</b> <b>1100 7944</b> <b>1125 8963</b>	<b>BANTAM to BANTAM - BLACK</b> 
<b>Bantam to Bantam, (6')</b> <b>Bantam to Bantam, (2')</b> <b>Bantam to Bantam, (4')</b> <b>Bantam to Bantam, (10')</b> <b>Bantam to Bantam, (12')</b> <b>Bantam to Bantam, (15')</b> <b>Bantam to Bantam, (20')</b> <b>Bantam to Bantam, (25')</b> <b>Bantam to Bantam, (30')</b> <b>Bantam to Bantam, (40')</b> <b>Bantam to Bantam, (50')</b> <ul style="list-style-type: none"> <li>• General purpose test / patch cord</li> </ul>	<b>400210</b> <b>400210-02</b> <b>400210-04</b> <b>400210-10</b> <b>400210-12</b> <b>400210-15</b> <b>400210-20</b> <b>400210-25</b> <b>400210-30</b> <b>400210-40</b> <b>400210-50</b>	<b>8721 4240</b> <b>8727 2187</b> <b>8727 3292</b> <b>8725 7313</b> <b>8724 0825</b> <b>8727 3294</b> <b>8723 6197</b> <b>8727 4263</b> <b>8722 2495</b> <b>8726 0958</b> <b>1105 1326</b>	<b>BANTAM to BANTAM</b> 
<b>Right Angle Bantam to Right Angle Bantam, (2')</b> <b>Right Angle 310 to Right Angle 310, (2')</b> <ul style="list-style-type: none"> <li>• "Right Angle" test cord for "Patching" T1 circuits inside SLC Series 5 or SLC-96 cabinets</li> </ul>	<b>400210R</b> <b>400310R</b>	<b>363418</b> <b>8703 1754</b>	<b>RIGHT ANGLE PATCH CORD</b> 

# Verizon Patch Cords

FEATURES / APPLICATION	PART #	VZ ID #	DESCRIPTION
<b>Bantam to 310, (6')</b> <b>Bantam to 310, (10')</b> <b>Bantam to 310, (12')</b> <b>Bantam to 310, (20')</b> <b>Bantam to 310, (25')</b> <b>Bantam to 310, (40')</b> <ul style="list-style-type: none"> <li>• General purpose test / patch cord</li> </ul>	<b>400310M</b> <b>400310M-10</b> <b>400310M-12</b> <b>400310M-20</b> <b>400310M-25</b> <b>400310M-40</b>	<b>8702 8145</b> <b>8726 1459</b> <b>8725 6116</b> <b>8724 7963</b> <b>1104 1392</b> <b>8726 0960</b>	<b>BANTAM to 310</b> 
<b>310 to 310 - RED, (13')</b> <ul style="list-style-type: none"> <li>• General purpose test / patch cord</li> </ul>	<b>400310RD-13</b>	<b>1125 8964</b>	<b>310 to 310 - RED</b> 
<b>310 to 310 - BLACK, (13')</b> <ul style="list-style-type: none"> <li>• General purpose test / patch cord</li> </ul>	<b>400310BK-13</b>	<b>1125 8965</b>	<b>310 to 310 - BLACK</b> 
<b>310 to 310, (6')</b> <b>310 to 310, (30')</b> <b>310 to 310, (40')</b> <ul style="list-style-type: none"> <li>• General purpose test / patch cord</li> </ul>	<b>400310</b> <b>400310-30</b> <b>400310-40</b>	<b>8702 8133</b> <b>8727 8046</b> <b>8726 0959</b>	<b>310 to 310</b> 
<b>Dual 310 to Dual 310, (6')</b> <ul style="list-style-type: none"> <li>• Patch cord</li> <li>• Available in various lengths</li> </ul>	<b>400310DD</b>	<b>8702 8107</b>	<b>DUAL 310 to DUAL 310</b> 
<b>Dual Bantam to Dual Bantam, (6')</b> <b>Dual Bantam to Dual Bantam, (2')</b> <b>Dual Bantam to Dual Bantam, (10')</b> <b>Dual Bantam to Dual Bantam, (12')</b> <b>Dual Bantam to Dual Bantam, (15')</b> <b>Dual Bantam to Dual Bantam, (20')</b> <b>Dual Bantam to Dual Bantam, (25')</b> <b>Dual Bantam to Dual Bantam, (30')</b> <b>Dual Bantam to Dual Bantam, (40')</b> <b>Dual Bantam to Dual Bantam, (50')</b> <b>Dual Bantam to Dual Bantam, (75')</b> <ul style="list-style-type: none"> <li>• General purpose test / patch cord</li> </ul>	<b>400210DD</b> <b>400210DD-02</b> <b>400210DD-10</b> <b>400210DD-12</b> <b>400210DD-15</b> <b>400210DD-20</b> <b>400210DD-25</b> <b>400210DD-30</b> <b>400210DD-40</b> <b>400210DD-50</b> <b>400210DD-75</b>	<b>8702 8141</b> <b>8725 6802</b> <b>8725 6615</b> <b>364581</b> <b>1136 1856</b> <b>8723 8449</b> <b>8727 5015</b> <b>8722 5337</b> <b>8725 0208</b> <b>8728 6622</b> <b>8728 4587</b>	<b>DUAL BANTAM to DUAL BANTAM</b> 

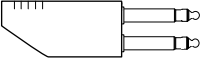
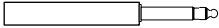
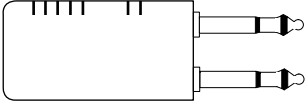
# Verizon Patch Cords

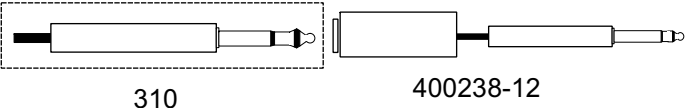
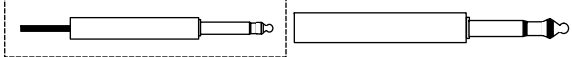
FEATURES / APPLICATION	PART #	DESCRIPTION
<p><b>Bantam Looping Plug</b></p> <ul style="list-style-type: none"> <li>3 conductor looping plug</li> </ul>	<p>400210LP</p> <p><b>VZ ID # 1100 7945</b></p>	<p><b>BANTAM LOOPING PLUG</b></p> 
<p><b>Bantam Terminating Plug</b></p> <ul style="list-style-type: none"> <li>100 ohm terminating plug</li> </ul>	<p>400210TP-1</p> <p><b>VZ ID # 8721 3871</b></p>	<p><b>BANTAM TERMINATING PLUG</b></p> 
<p><b>310 Looping Plug</b></p> <ul style="list-style-type: none"> <li>3 conductor looping plug</li> </ul>	<p>400310LP</p> <p><b>VZ ID # 8702 8137</b></p>	<p><b>310 LOOPING PLUG</b></p> 
<p><b>310 Terminating Plug</b></p> <ul style="list-style-type: none"> <li>100 ohm terminating plug</li> </ul>	<p>400310TP-1</p> <p><b>VZ ID # 8702 8095</b></p>	<p><b>310 TERMINATING PLUG</b></p> 
<p><b>310 (female) to Bantam Conversion Cord, (12")</b></p> <ul style="list-style-type: none"> <li>310 Plugs into adapter converting to Bantam</li> </ul>	<p>400238-12</p> <p><b>VZ ID # 8702 8140</b></p>	<p><b>310 to BANTAM CONVERSION CORD</b></p> 
<p><b>Bantam to 310 Conversion Plug</b>  <b>Bantam to 310 Conversion Plug, Black</b>  <b>Bantam to 310 Conversion Plug, Red</b></p> <ul style="list-style-type: none"> <li>Slides over Bantam Plug converting it to a 310</li> </ul>	<p><b>PART #</b>  400239  400239BK  400239RD</p> <p><b>VZ ID #</b>  8703 1594  1105 3690 - Bk  1105 3689 - Rd</p>	<p><b>BANTAM TO 310 CONVERSION PLUG</b></p>  <p>BANTAM</p> <p>400239, 400239RD or 400239BK</p>

# DSX-1

# Color Coded Patch / Test Cords

## Bantam to Bantam

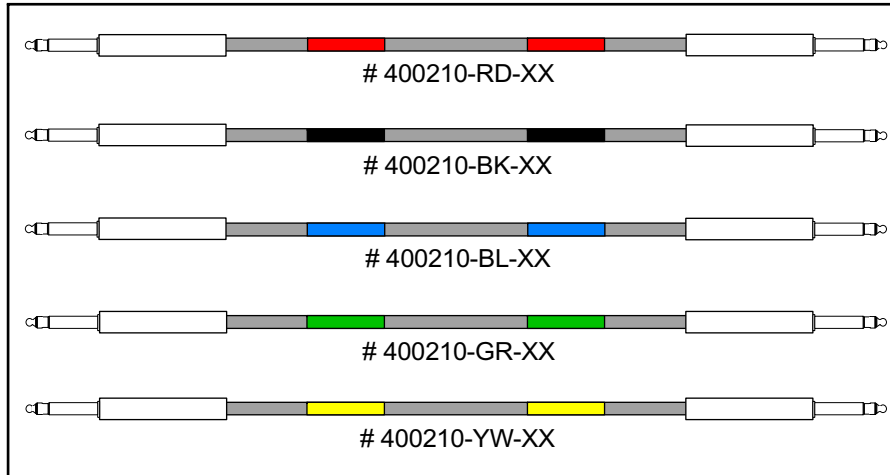

## 310 to 310

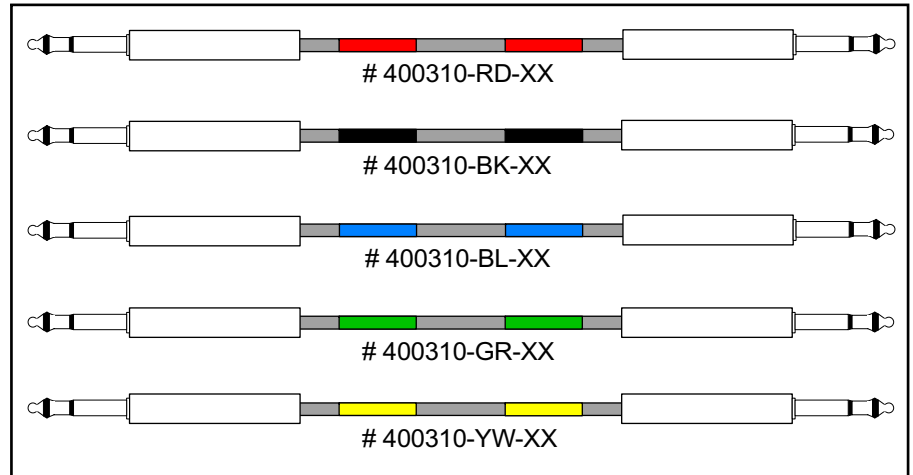

## Dual Bantam to Dual Bantam

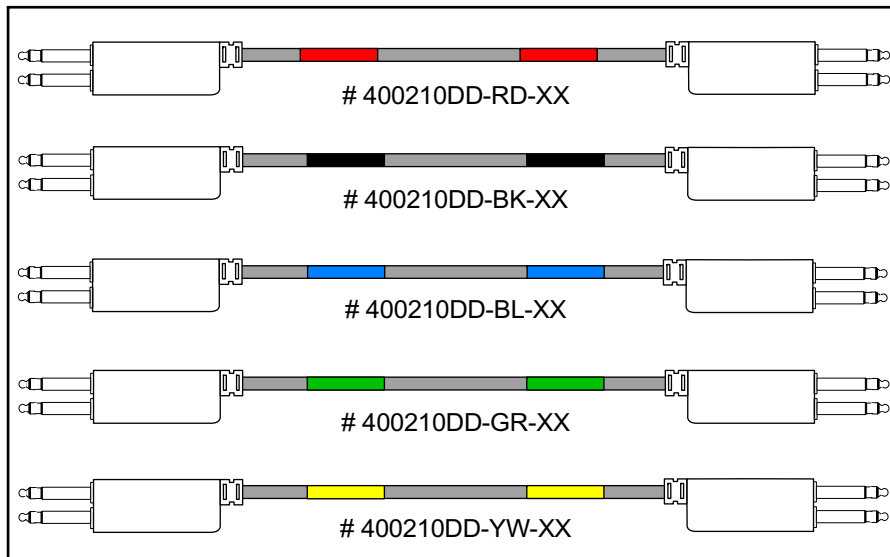

## Dual 310 to Dual 310

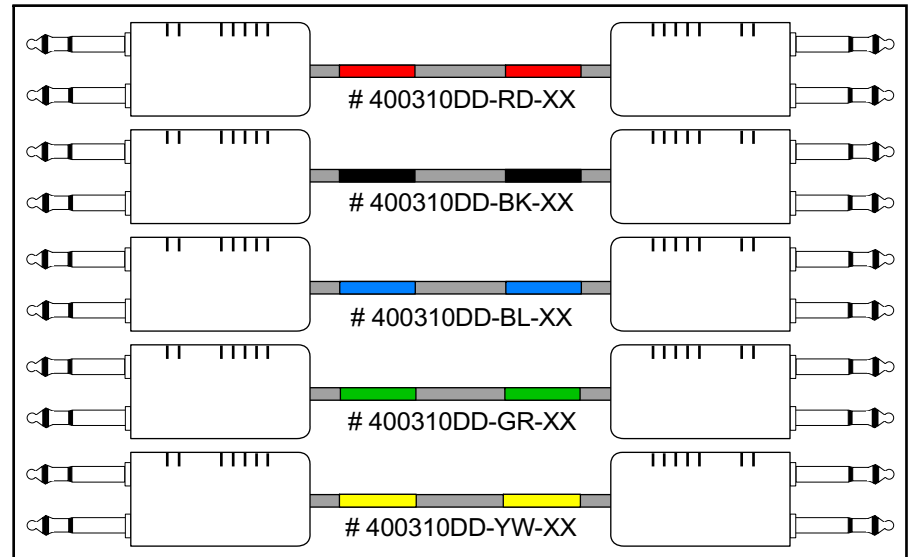

\* XX represents the numeric digits that correspond with the *desired length* of cord. Cords available in **ANY** length.

**EXAMPLE: # 400210-BL-06** (Bantam to Bantam **BLUE** 6' long)

150 Cooper Rd. (F-15)  
W. Berlin, NJ 08091

[www.tagcords.com](http://www.tagcords.com)

**Telecom Assistance Group**

Telephone: (856) 753-8585

Fax: (856) 768-7645