

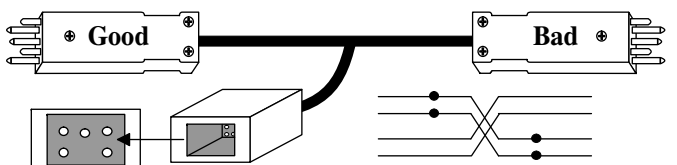





Frame Cords for Lumen / CenturyLink

FEATURES / APPLICATION	PART #	DESCRIPTION
<p>463A Plug to Alligator Clips, (2') 463A Plug to Alligator Clips, (6')</p> <ul style="list-style-type: none"> • Long pins wired to Alligator clips • Non-bridging - Flip to look both ways 463A type plug (protector) to alligator clips • Similar to W2GL 	<p>ST400300S-02 ST400300S-06</p>	<p>463A PLUG to ALLIGATOR CLIPS</p>  <p>2' MAT # 1157465 6' MAT # 1157466</p>
<p>Protector to Protector "Frogger" with "In Line Protection", (20')</p> <ul style="list-style-type: none"> • Frogger with In-Line Protection • Ideal for quick temporary restoral with "protection" 	<p>400300FP</p>	<p>"FROGGER" w/ IN-LINE PROTECTION</p>  <p>MAT # 1157486</p>
<p>Protector to (4) Alligator Clips, (8')</p> <ul style="list-style-type: none"> • Access at (coils) both cable and equipment 	<p>400300S-4</p>	<p>PROTECTOR to (4) ALLIGATOR CLIPS</p>  <p>MAT # 1157485</p>
<p>526A plug to Alligator Clips, (2')</p> <ul style="list-style-type: none"> • Monitor access to Protectors via test points without pulling Protector • Equivalent to P2FL 	<p>400526A-02</p>	<p>526A PLUG to ALLIGATOR CLIPS</p>  <p>MAT # 1157469</p>

Frame Cords for Lumen / CenturyLink

FEATURES / APPLICATION	PART #	DESCRIPTION
<p>Dual Push Pins (310 MDF) to Alligator Clips, (3')</p> <ul style="list-style-type: none"> Used to short the tip and ring or to ground the tip and/or ring Plugs to recessed terminals on 310 series connectors Equivalent to P2FM 	400426	<p>DUAL PUSH PINS to ALLIGATOR CLIPS</p>  <div style="text-align: right; background-color: black; color: white; padding: 2px 5px; font-weight: bold;">MAT # 1157484</div>
<p>453A plug to Alligator Clips, (3')</p> <ul style="list-style-type: none"> Used to short the tip and ring or to ground the tip and/or ring Plugs to recessed terminals on 300 series connectors (except 310) Equivalent to P2EF 	400430	<p>453A PLUG to ALLIGATOR CLIPS</p>  <div style="text-align: right; background-color: black; color: white; padding: 2px 5px; font-weight: bold;">MAT # 1157481</div>
<p>Bantam to 800 DSX, (6')</p> <ul style="list-style-type: none"> Test equipment access to 800 DSX 	408210	<p>BANTAM to 800 DSX</p>  <div style="text-align: right; background-color: black; color: white; padding: 2px 5px; font-weight: bold;">MAT # 1157181</div>
<p>310 to 800 DSX, (12')</p> <ul style="list-style-type: none"> Test equipment access to 800 DSX 	408310-12	<p>310 to 800 DSX</p>  <div style="text-align: right; background-color: black; color: white; padding: 2px 5px; font-weight: bold;">MAT # 1183104</div>
<p>800 DSX Looping Plug</p> <ul style="list-style-type: none"> Loops both directions 	408800LD	<p>800 DSX LOOPING PLUG</p>  <div style="text-align: right; background-color: black; color: white; padding: 2px 5px; font-weight: bold;">MAT # 1157470</div>
<p>800 DSX Terminating Plug</p> <ul style="list-style-type: none"> Available in 100 ohm 	408800TP-1	<p>800 DSX TERMINATING PLUG</p>  <div style="text-align: right; background-color: black; color: white; padding: 2px 5px; font-weight: bold;">MAT # 1335085</div>

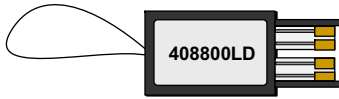
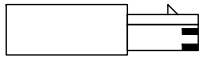
"Frogger" Protector Test Cord, (20')

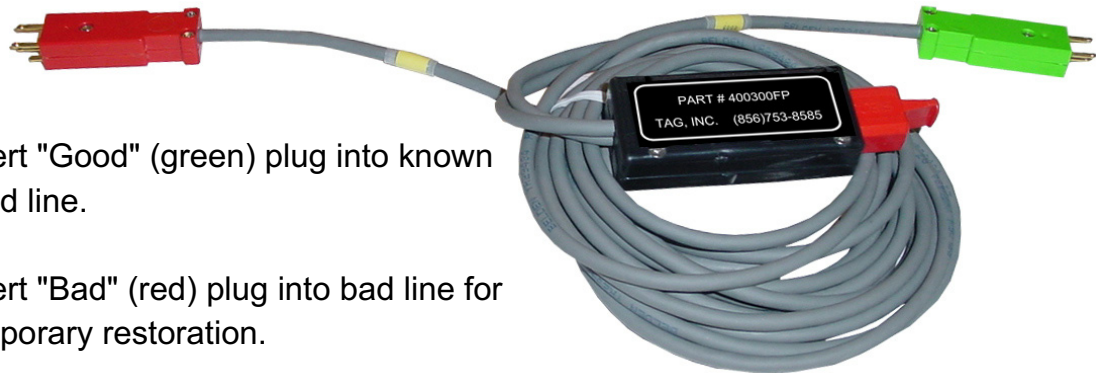

1. Insert "Good" (green) plug into known good line.
2. Insert "Bad" (red) plug into bad line for temporary restoration.

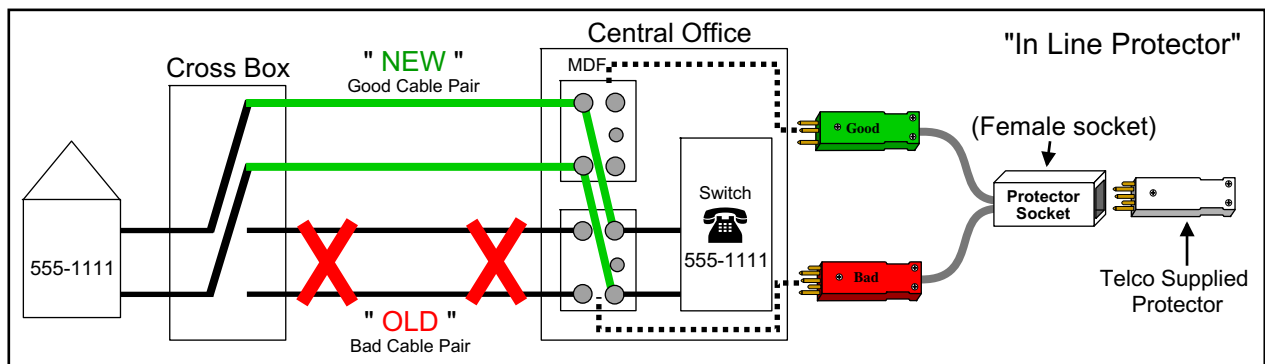

Application:

TAG's Temporary Restoral Cord (400300FP) allows you to add protection back to the telephone line when testing. TAG's test cord features a built-in protector socket that accepts any 5-pin protector module. A 5-pin module with the same specifications as the line you are testing on must be inserted before the test cord can function. Once inserted, the cord will now function and protection has been restored to the line.

In the event of a power or lightning strike, TAG's 400300FP can save thousands of dollars by eliminating dangers that can destroy expensive equipment or possibly harm a technician. One plug is Green "GOOD" & the other plug is Red "BAD". When the repair is made, the circuit can be identified as to which pair is good or bad.

Ordering Information:

400300FP

"Frogger" Protector Test Cord - (20')

Lumen/CLK MAT #

1157486

150 Cooper Rd. (F-15)
 W. Berlin, NJ 08091

www.tagcords.com

Telephone: (856) 753-8585
 Fax : (856) 768-7645

Telecom Assistance Group