

AT&T 2025 Ordering Guide

Issue 1.0

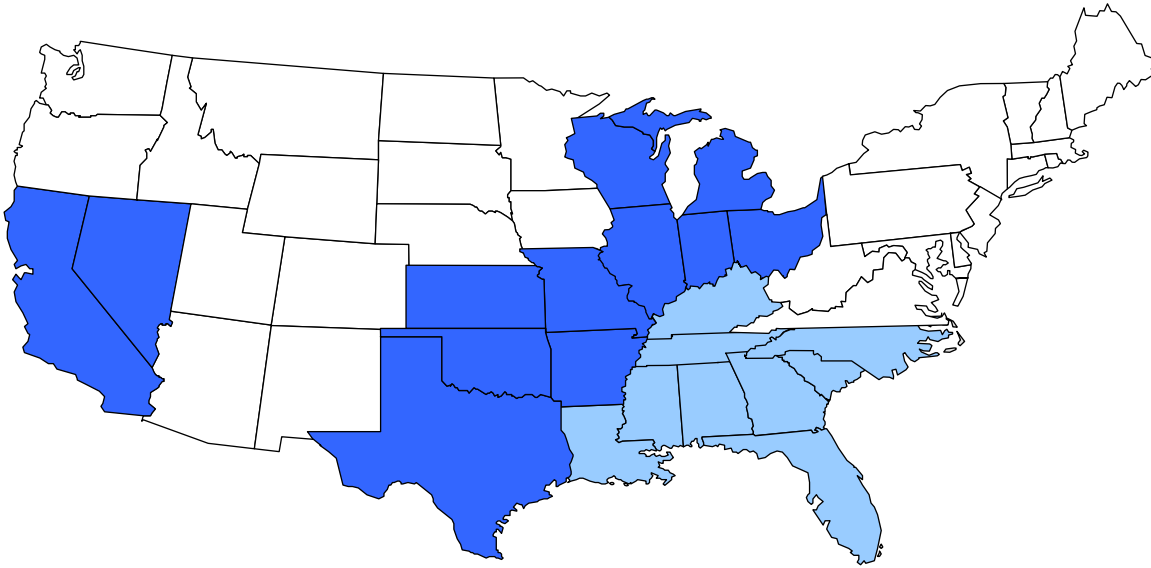

Provided By:



TAG INC.

Telecom Assistance Group, Inc.

The "Cord Company" and more . . .

"TEST CORDS & ADAPTERS"



"T1 REPEATERS & EXTENDERS"

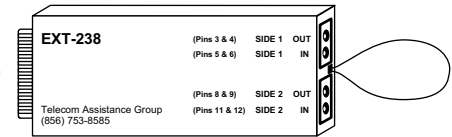

"DUMB TERMINALS"



"FANS"

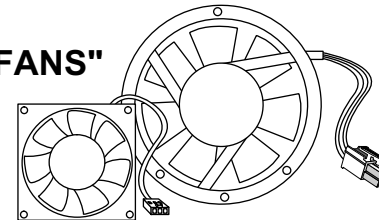

"NEBS CERTIFIED SOLID STATE SCSI DRIVES"

*30+ Items are Available
- UPFRONT REPAIRS -*

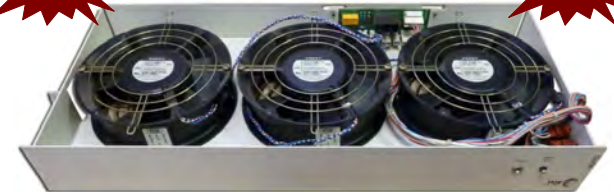





FAN TRAY & RECTIFIER REFURBISHING



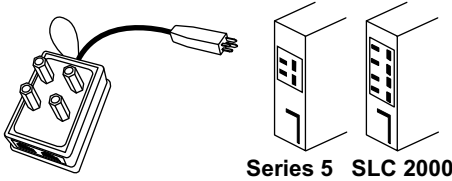
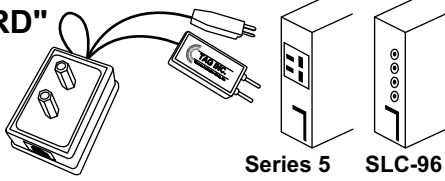
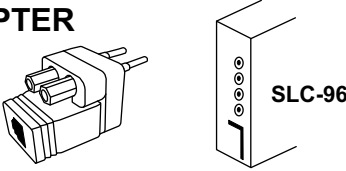
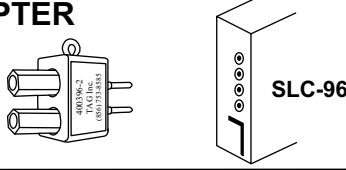
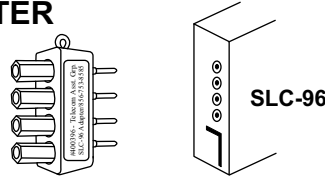
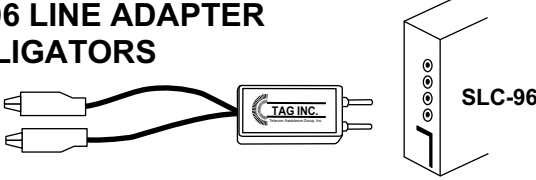

www.tagcords.com



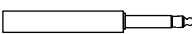
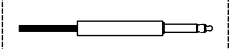
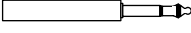



-

856-753-8585





FEATURES / APPLICATION	PART #	DESCRIPTION
<p>SLC Series 5 Test Cord, (3')</p> <ul style="list-style-type: none"> Hollow post (Alligator Clip access) and/or modular (RJ11) access to Odd/Even channels Dial tone access at faceplate of Series 5 or SLC 2000 	<p>400395</p> <p>AT&T PID # ATT.100409660</p>	<p>SLC SERIES 5 TEST CORD</p>  <p>Series 5 SLC 2000</p>
<p>"The SLICK CORD", (2')</p> <ul style="list-style-type: none"> Dual Purpose cord for Series 5/SLC 2000 and/or SLC-96/DISC*S faceplate access 	<p>4003956</p> <p>AT&T PID # ATT.100000821</p>	<p>"SLICK CORD"</p>  <p>Series 5 SLC-96</p>
<p>SLC-96 Line Adapter</p> <ul style="list-style-type: none"> Hollow post and/or modular access to Odd/Even Channels at faceplate of SLC-96/DISC*S 	<p>400396-2M</p> <p>12 STATE ATT.100041272</p> <p>SOUTHEAST ATT.100000731</p>	<p>SLC-96 LINE ADAPTER</p>  <p>SLC-96</p>
<p>SLC-96 Line Adapter</p> <ul style="list-style-type: none"> Hollow post access to Odd/Even Channels at faceplate of SLC-96/DISC*S channel units 	<p>400396-2</p> <p>AT&T PID # ATT.100000507</p>	<p>SLC-96 LINE ADAPTER</p>  <p>SLC-96</p>
<p>SLC-96 Line Adapter</p> <ul style="list-style-type: none"> Hollow post access to Odd/Even Channels at faceplate of SLC-96/DISC*S channel units 	<p>400396</p> <p>12 STATE ATT.100080893</p> <p>SOUTHEAST ATT.100000677</p>	<p>SLC-96 LINE ADAPTER</p>  <p>SLC-96</p>
<p>SLC-96 Line Adapter to Alligator Clips, (1')</p> <ul style="list-style-type: none"> Use at faceplate or SLC-96 or DISC*S channel units to get dial tone access Easy alligator connection to butt-sets 	<p>400396-2A</p> <p>12 STATE ATT.100041968</p> <p>SOUTHEAST ATT.100011807</p>	<p>SLC-96 LINE ADAPTER to ALLIGATORS</p>  <p>SLC-96</p>



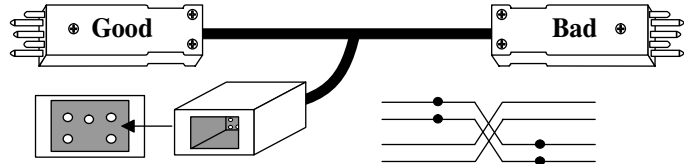
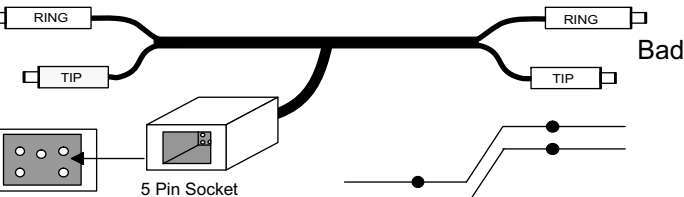
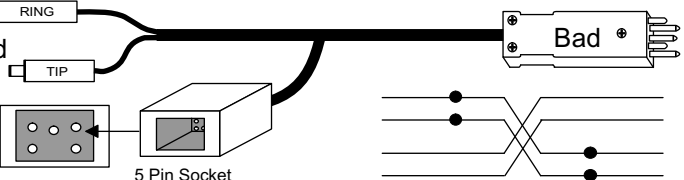
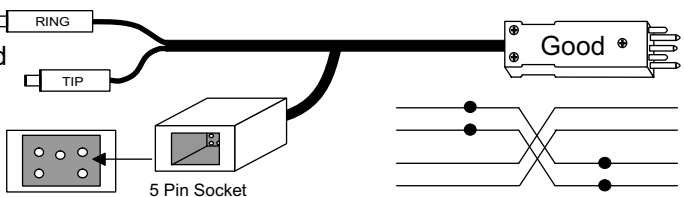

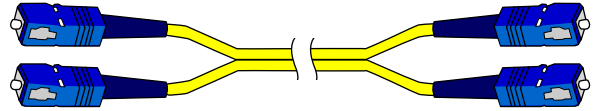
FEATURES / APPLICATION	PART #	DESCRIPTION
<p>Bantam to Bantam, (6') (RED) Bantam to Bantam, (6') (BLACK)</p> <ul style="list-style-type: none"> Patching or Test Set Application Red / Black colors for Transmit / Receive 	<p>400210RD 400210BK</p> <div style="display: flex; justify-content: center; align-items: center; gap: 10px;"> <div style="background-color: black; color: white; padding: 2px 5px; text-align: center;"> <u>AT&T PID #</u> ATT.100068132 ATT.100408970 </div> <div style="text-align: center;"> Red Black </div> </div>	<p>BANTAM to BANTAM - RED BANTAM to BANTAM - BLACK</p> 
<p>Bantam to (2) Alligator Clips, (6')</p> <ul style="list-style-type: none"> Access to various connectors, bare cable 	<p>400210A</p> <div style="display: flex; justify-content: center; align-items: center; gap: 10px;"> <div style="background-color: black; color: white; padding: 2px 5px; text-align: center;"> <u>12 STATE</u> ATT.100038299 </div> <div style="background-color: black; color: white; padding: 2px 5px; text-align: center;"> <u>SOUTHEAST</u> ATT.100000681 </div> </div>	<p>BANTAM to ALLIGATOR CLIPS</p> 
<p>Bantam to Mini Test Clips, (6')</p> <ul style="list-style-type: none"> "Mini Grabbers" excellent for access to various connectors, wire terminals 	<p>400210T</p> <div style="background-color: black; color: white; padding: 2px 5px; text-align: center; margin: 10px auto; width: 100px;"> <u>AT&T PID #</u> ATT.100407310 </div>	<p>BANTAM to MINI TEST CLIPS</p> 
<p>Bantam to Wire Wrap Terminals, (6')</p> <ul style="list-style-type: none"> Slides on standard CO terminal block pins (.045) for test access 	<p>400210WP</p> <div style="background-color: black; color: white; padding: 2px 5px; text-align: center; margin: 10px auto; width: 100px;"> <u>AT&T PID #</u> ATT.100000799 </div>	<p>BANTAM to WIRE WRAP TERMINALS</p> 
<p>Bantam Terminating Plug</p> <ul style="list-style-type: none"> 100 ohm Terminating Plug 	<p>B004210TP-100</p> <div style="display: flex; justify-content: center; align-items: center; gap: 10px;"> <div style="background-color: black; color: white; padding: 2px 5px; text-align: center;"> <u>12 STATE</u> ATT.100038211 </div> <div style="background-color: black; color: white; padding: 2px 5px; text-align: center;"> <u>SOUTHEAST</u> ATT.100000599 </div> </div>	<p>BANTAM TERMINATING PLUG</p> 
<p>Bantam to 310 Conversion Plug</p> <ul style="list-style-type: none"> Slides over bantam plug converting it to a 310 	<p>400239BST</p> <div style="display: flex; justify-content: center; align-items: center; gap: 10px;"> <div style="background-color: black; color: white; padding: 2px 5px; text-align: center;"> <u>12 STATE</u> ATT.100035887 </div> <div style="background-color: black; color: white; padding: 2px 5px; text-align: center;"> <u>SOUTHEAST</u> ATT.100000515 </div> </div>	<p>BANTAM TO 310 CONVERSION PLUG</p> <div style="display: flex; align-items: center; justify-content: center; gap: 20px;"> <div style="border: 1px dashed black; padding: 5px;">  <p style="text-align: center; margin: 0;">BANTAM</p> </div> <div style="text-align: center;">  <p>400239BST</p> </div> </div>

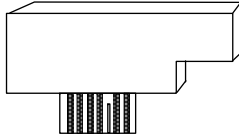

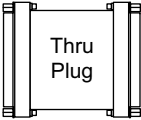
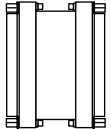

FEATURES / APPLICATION	PART #	DESCRIPTION
<p>Bantam to 800 DSX, (6') Bantam to 800 DSX, (25')</p> <ul style="list-style-type: none"> • Test equipment access to 800 DSX 	<p>408210 408210-25</p> <p>AT&T PID # ATT.10000815 6' ATT.10000841 25'</p>	<p>BANTAM to 800 DSX</p> 
<p>800 DSX (male) to Bantam (female), (2')</p> <ul style="list-style-type: none"> • Plug Bantam into female Bantam converts to 800 DSX 	<p>408210F</p> <p>AT&T PID # ATT.10000817</p>	<p>800 DSX (male) to BANTAM (female)</p> 
<p>310 to 800 DSX, (6')</p> <ul style="list-style-type: none"> • Test equipment access to 800 DSX 	<p>408310</p> <p>12 STATE ATT.100041960</p> <p>SOUTHEAST ATT.10000823</p>	<p>310 to 800 DSX</p> 
<p>800 DSX to 800 DSX, (12')</p> <ul style="list-style-type: none"> • 800 DSX patch cord • Available in various lengths 	<p>408800-12</p> <p>AT&T PID # ATT.10000839</p>	<p>800 DSX to 800 DSX</p> 
<p>800 DSX Terminating Plug</p> <ul style="list-style-type: none"> • 100 ohm Terminating Plug 	<p>408800TP-1</p> <p>12 STATE ATT.100076980</p> <p>SOUTHEAST ATT.100000619</p>	<p>800 DSX TERMINATING PLUG</p> 

FEATURES / APPLICATION	PART #	DESCRIPTION
<p>526A plug to Alligator Clips, (6')</p> <ul style="list-style-type: none"> Monitor access to Protectors via test points without pulling Protector Equivalent to P2FL 	<p>400526A</p> <div style="display: flex; justify-content: space-around; margin-top: 10px;"> <div style="background-color: black; color: white; padding: 2px 5px; text-align: center;"> 12 STATE ATT.100035489 </div> <div style="background-color: black; color: white; padding: 2px 5px; text-align: center;"> SOUTHEAST ATT.100001789 </div> </div>	<p>526A PLUG to ALLIGATOR CLIPS</p> 
<p>Dual Push Pins (310 MDF) to Alligator Clips, (3')</p> <ul style="list-style-type: none"> Used to short the tip and ring or to ground the tip and/or ring Plugs to recessed terminals on 310 series connectors Equivalent to P2FM 	<p>400426</p> <div style="background-color: black; color: white; padding: 2px 5px; text-align: center; margin-top: 10px;"> AT&T PID # ATT.100000769 </div>	<p>DUAL PUSH PINS to ALLIGATOR CLIPS</p> 
<p>Protector (non-bridging) to Alligator Clips, (8')</p> <ul style="list-style-type: none"> Test access at coils 	<p>400300S</p> <div style="background-color: black; color: white; padding: 2px 5px; text-align: center; margin-top: 10px;"> AT&T PID # ATT.100001291 </div>	<p>PROTECTOR to ALLIGATOR CLIPS</p> 
<p>Protector to Alligator Clips, (3')</p> <ul style="list-style-type: none"> Test access at MDF (coils) 	<p>400300C-3</p> <div style="display: flex; justify-content: space-around; margin-top: 10px;"> <div style="background-color: black; color: white; padding: 2px 5px; text-align: center;"> 12 STATE ATT.100041964 </div> <div style="background-color: black; color: white; padding: 2px 5px; text-align: center;"> SOUTHEAST ATT.100000729 </div> </div>	<p>PROTECTOR to ALLIGATOR CLIPS</p> 
<p>453A plug to Alligator Clips, (3')</p> <ul style="list-style-type: none"> Used to short the tip and ring or to ground the tip and/or ring Plugs to recessed terminals on 300 series connectors (except 310) Equivalent to P2EF 	<p>400430</p> <div style="background-color: black; color: white; padding: 2px 5px; text-align: center; margin-top: 10px;"> AT&T PID # ATT.100001785 </div>	<p>453A PLUG to ALLIGATOR CLIPS</p> 
<p>MDF Shorting cord</p> <ul style="list-style-type: none"> 453A plug looped Used at 303, 304, and 308 MDF frames 	<p>400430L</p> <div style="background-color: black; color: white; padding: 2px 5px; text-align: center; margin-top: 10px;"> AT&T PID # ATT.100001437 </div>	<p>MDF SHORTING CORD</p> 

FEATURES / APPLICATION	PART #	DESCRIPTION
<p>Protector to Protector "Frogger" with "In-Line Protection", (20')</p> <ul style="list-style-type: none"> • "The Green Cord" • Frogger with In-Line Protection • Ideal for quick temporary restoral with "protection" 	<p>400300FP</p> <p>AT&T PID # ATT.100111566</p>	<p>"FROGGER" w/ IN-LINE PROTECTION</p> 
<p>412 type plug to 412 type plug "Frogger" with In-Line Protection, (20')</p> <ul style="list-style-type: none"> • Frogger with In-Line Protection • Ideal for quick temporary restoral with "protection" on older frames 	<p>400412FP</p> <p>AT&T PID # ATT.100115083</p>	<p>412 "FROGGER" w/ IN-LINE PROTECTION</p> 
<p>412 type plug to 5 Pin plug "Frogger" with "In-Line Protection", (20')</p> <ul style="list-style-type: none"> • Conversion Frogger (252 to 412) with In-Line Protection • 412 side is labeled "GOOD" 	<p>400434FP1</p> <p>AT&T PID # ATT.100115084</p>	<p>412 to 5 PIN "FROGGER" w/ IN-LINE PROTECTION</p> 
<p>412 type plug to 5 Pin plug "Frogger" with "In-Line Protection", (20')</p> <ul style="list-style-type: none"> • Conversion Frogger (252 to 412) with In-Line Protection • 412 side is labeled "BAD" 	<p>400434FP2</p> <p>AT&T PID # ATT.100115085</p>	<p>412 to 5 PIN "FROGGER" w/ IN-LINE PROTECTION</p> 

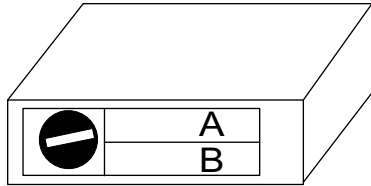

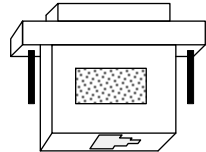

FEATURES / APPLICATION	PART #	DESCRIPTION
<p>SC to SC, Singlemode Duplex, 2.0mm Yellow, UPC, (10')</p> <ul style="list-style-type: none"> SINGLEMODE: Link between bulkhead adapters and terminal equipment 	<p>400766D-10</p> <p>12 STATE Call for Pricing</p> <p>SOUTHEAST ATT.100016000</p>	<p>DUPLEX SC to DUPLEX SC</p> 
<p>310 to 310 (Right Angle), (2')</p> <ul style="list-style-type: none"> "RIGHT ANGLE" allows greater clearance Commonly used in SLC Series 5 and SLC-96 cabinets 	<p>400310R</p> <p>AT&T PID # ATT.100015427</p>	<p>310 to 310 (RIGHT ANGLE)</p> 
<p>Wire Wraps to Mini Alligator Clips, (1') Wire Wraps to Mini Alligator Clips, (4')</p> <ul style="list-style-type: none"> Slides on wire wraps Alligator Clip connections to butt sets, Caller ID, etc. 	<p>B00200MA-01 B00200MA-04</p> <p>12 STATE ATT.100041986 ATT.100038303</p> <p>SOUTHEAST ATT.100000617 ATT.100000625</p>	<p>WIRE WRAPS to MINI ALLIGATOR CLIPS</p>  <p>1' 4'</p>
<p>SLC-96 Looping Plug</p> <ul style="list-style-type: none"> Loops SLC-96 circuits at the LIU 	<p>400396L</p> <p>12 STATE ATT.100080916</p> <p>SOUTHEAST ATT.100000889</p>	<p>SLC 96 LOOPING PLUG</p> 
<p>15 Pin (female) to LIU "low profile" connector, (8')</p> <ul style="list-style-type: none"> Connects Power Panel to LIU for test jack access "Low Profile" allows greater door clearance at SLC cabinets 	<p>400442FL</p> <p>12 STATE ATT.100013510</p> <p>SOUTHEAST ATT.100000903</p>	<p>15 PIN to LIU</p> 

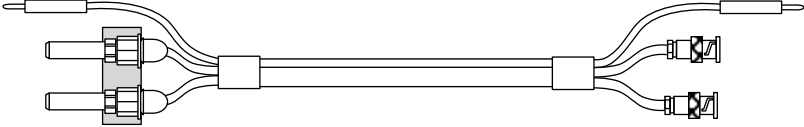
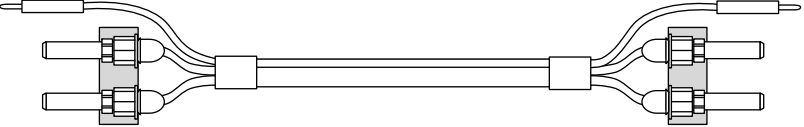
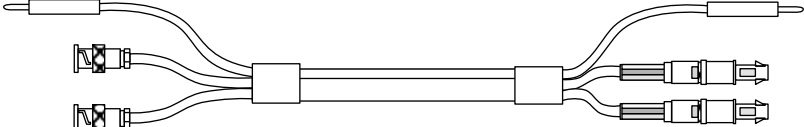

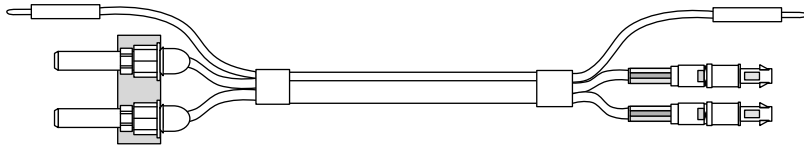
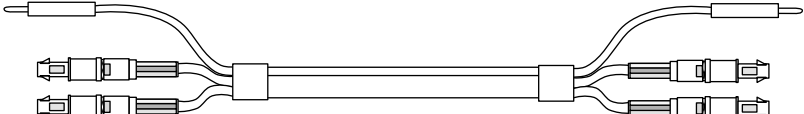
FEATURES / APPLICATION	PART #	DESCRIPTION
<p>Thru Plug 25 Pin (female/male)</p> <ul style="list-style-type: none"> Use between TNS and printer Allows data to be received if printer down (out of paper) 	<p>400780</p> <div style="background-color: black; color: white; padding: 2px; text-align: center; margin-top: 5px;"> AT&T PID # ATT.100001283 </div>	<p>THRU PLUG 25 PIN (f/m)</p> <div style="text-align: right; margin-top: 10px;">  </div>
<p>DB 25 Pin (male) to (male) gender changer</p> <ul style="list-style-type: none"> Standard Serial Gender Changer 	<p>400701</p> <div style="display: flex; justify-content: space-around; margin-top: 5px;"> <div style="background-color: black; color: white; padding: 2px; text-align: center;"> 12 STATE ATT.100071961 </div> <div style="background-color: black; color: white; padding: 2px; text-align: center;"> SOUTHEAST ATT.100001269 </div> </div>	<p>25 PIN (m) to 25 PIN (m) GENDER CHANGER</p> <div style="text-align: right; margin-top: 10px;">  </div>
<p>HDSL Provisioning Test Cord</p> <ul style="list-style-type: none"> DB 25 Pin (male) to DB 9 Pin (male) for HDSL provisioning from "Dumb" terminals 	<p>400703H-06, 400703H-10 400703H-15, 400703H-20 400703H-25</p> <div style="display: flex; justify-content: space-around; margin-top: 5px;"> <div style="background-color: black; color: white; padding: 2px; text-align: center;"> 12 STATE ATT.100038373 ATT.100041978 ATT.100041979 ATT.100041980 ATT.100041981 </div> <div style="background-color: black; color: white; padding: 2px; text-align: center;"> SOUTHEAST ATT.100000581 ATT.100000595 ATT.100000603 ATT.100000623 ATT.100000649 </div> </div>	<p>HDSL PROVISIONING TEST CORD</p> <div style="text-align: right; margin-top: 10px;">  </div>
<p>25 Pin (male) to 25 Pin (female), (6')</p> <ul style="list-style-type: none"> Standard serial printer cable 	<p>400706</p> <div style="display: flex; justify-content: space-around; margin-top: 5px;"> <div style="background-color: black; color: white; padding: 2px; text-align: center;"> 12 STATE ATT.100041954 </div> <div style="background-color: black; color: white; padding: 2px; text-align: center;"> SOUTHEAST ATT.100001001 </div> </div>	<p>SERIAL PRINTER CABLE</p> <div style="text-align: right; margin-top: 10px;">  </div>
<p>25 Pin (male) to 36 (centronics), (6')</p> <ul style="list-style-type: none"> Standard parallel printer cable 	<p>400707</p> <div style="background-color: black; color: white; padding: 2px; text-align: center; margin-top: 5px;"> AT&T PID # ATT.100000999 </div>	<p>PARALLEL PRINTER CABLE</p> <div style="text-align: right; margin-top: 10px;">  </div>





FEATURES / APPLICATION	PART #	DESCRIPTION
<p>DB 25 Pin "A/B" Position Switch Box</p> <ul style="list-style-type: none"> 3 female 25 Pin connectors 	<p>400712</p> <p>AT&T PID # ATT.100001017</p>	<p>DB 25 PIN "A/B" SWITCH BOX</p> 
<p>Bantam "Y" to 800 Duplex (Orange Cord), (8')</p> <ul style="list-style-type: none"> "Orange Cord" monitors both directions 	<p>408805-08</p> <p>AT&T PID # ATT.100000837</p>	<p>BANTAM "Y" to 800 DUPLEX (Orange Cord)</p> 
<p>DB 25 Pin (male) to RJ45 Adapter</p> <ul style="list-style-type: none"> 25 Pin adapter 	<p>400710</p> <p>AT&T PID # ATT.100000503</p>	<p>25 PIN (male) to RJ45 ADAPTER</p> 
<p>9 Pin (female) to 25 Pin (male), (6') 9 Pin (female) to 25 Pin (male), (25')</p> <ul style="list-style-type: none"> Standard laptop cable 	<p>400703-06 400703-25</p> <p>12 STATE ATT.100041976 ATT.100041977</p> <p>SOUTHEAST ATT.100000997 ATT.100000733</p> <p>6' 25'</p>	<p>LAPTOP CABLE</p> 

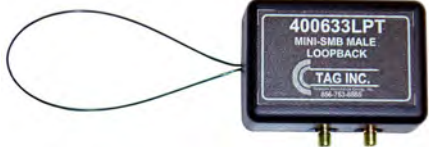

FEATURES / APPLICATION	DESCRIPTION	PART #	PID #
DSX-3/4 Patch / Test Cord w/ Tracer ("messenger") Wire <ul style="list-style-type: none"> A convenient way of patching Tx & Rx circuits at the same time Available in all lengths 	Dual 440D to Dual BNC w/ tracer, (15')	B00440DR-15	ATT.100038521
	Dual 440D to Dual BNC w/ tracer, (25')	B00440DR-25	ATT.100041988
	Dual 440D to Dual BNC w/ tracer, (36')	B00440DR-36	ATT.100041989
			
	<div style="display: flex; justify-content: space-around;"> <div style="text-align: center;"> <u>PART #</u> </div> <div style="text-align: center;"> <u>12 STATE</u> </div> <div style="text-align: center;"> <u>SOUTHEAST</u> </div> </div>		
DSX-3/4 Patch / Test Cord w/ Tracer ("messenger") Wire <ul style="list-style-type: none"> A convenient way of patching Tx & Rx circuits at the same time Available in all lengths 	Dual 440D to Dual 440D w/ tracer, (6')	400440DD-06	CALL
	Dual 440D to Dual 440D w/ tracer, (14')	400440DD-14	CALL
	Dual 440D to Dual 440D w/ tracer, (25')	400440DD-25	CALL
	Dual 440D to Dual 440D w/ tracer, (32')	400440DD-32	CALL
			
<div style="display: flex; justify-content: space-around;"> <div style="text-align: center;"> <u>PART #</u> </div> <div style="text-align: center;"> <u>12 STATE</u> </div> <div style="text-align: center;"> <u>SOUTHEAST</u> </div> </div>			
DSX-3/4 Patch / Test Cord w/ Tracer ("messenger") Wire <ul style="list-style-type: none"> A convenient way of patching Tx & Rx circuits at the same time Available in all lengths 	Dual BNC to Dual LCC Loopback	400470CB-LP	CALL
	Dual BNC to Dual LCC w/ tracer, (5')	400470CB-05	CALL
	Dual BNC to Dual LCC w/ tracer, (15')	400470CB-15	CALL
	Dual BNC to Dual LCC w/ tracer, (20')	400470CB-20	CALL
	Dual BNC to Dual LCC w/ tracer, (30')	400470CB-30	CALL
			
<div style="display: flex; justify-content: space-around;"> <div style="text-align: center;"> <u>PART #</u> </div> <div style="text-align: center;"> <u>12 STATE</u> </div> <div style="text-align: center;"> <u>SOUTHEAST</u> </div> </div>			

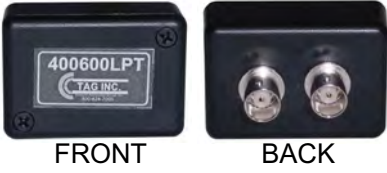

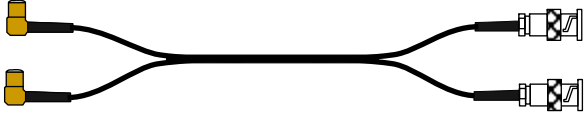

FEATURES / APPLICATION	DESCRIPTION	PART #	PID #
DSX-3/4 Patch/Test Cord w/ Tracer ("messenger") Wire <ul style="list-style-type: none"> A convenient way of patching Tx & Rx circuits at the same time Available in all lengths Locking Tabs & Spanners 	Dual 440D to Dual LCC Loopback	400470CD-LP	CALL
	Dual 440D to Dual LCC w/ tracer, (3')	B00470CD-03	ATT.100041990
	Dual 440D to Dual LCC w/ tracer, (5')	B00470CD-05	ATT.100038523
	Dual 440D to Dual LCC w/ tracer, (6')	400470CD-06	CALL
	Dual 440D to Dual LCC w/ tracer, (12')	400470CD-12	CALL
	Dual 440D to Dual LCC w/ tracer, (20')	400470CD-20	CALL
	Dual 440D to Dual LCC w/ tracer, (24')	B00470CD-24	ATT.100041991
	Dual 440D to Dual LCC w/ tracer, (30')	400470CD-30	CALL
	Dual 440D to Dual LCC w/ tracer, (36')	B00470CD-36	ATT.100038522
	Dual 440D to Dual LCC w/ tracer, (45')	400470CD-45	CALL
			
DSX-3/4 Patch/Test Cord w/ Tracer ("messenger") Wire <ul style="list-style-type: none"> A convenient way of patching Tx & Rx circuits at the same time Available in all lengths Locking Tabs 	Dual LCC to Dual LCC Loopback	400470CC-LP	CALL
	Dual LCC to Dual LCC w/ tracer, (5')	400470CC-05	CALL
	Dual LCC to Dual LCC w/ tracer, (15')	400470CC-15	CALL
	Dual LCC to Dual LCC w/ tracer, (30')	400470CC-30	CALL
	Dual LCC to Dual LCC w/ tracer, (45')	400470CC-45	CALL
			
DSX-3/4 Patch/Test Cord w/ Tracer ("messenger") Wire	Dual LCC to Dual 440 (<i>custom length</i>)	470CD-CONN	CALL
	Dual LCC to Dual LCC (<i>custom length</i>)	470CC-CONN	CALL
	Dual LCC to Dual BNC (<i>custom length</i>)	470CB-CONN	CALL



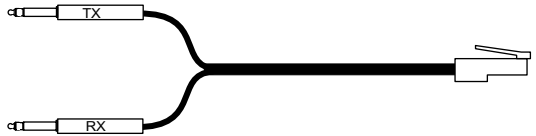

FEATURES / APPLICATION	DESCRIPTION	PART #	PID #
<p>BNC to BNC Test Cord (75 OHM Male)</p> <ul style="list-style-type: none"> General purpose test cord Available in various lengths 	<p>BNC to BNC, (2')</p> <p>BNC to BNC, (5')</p> <p>BNC to BNC, (8')</p> <p>BNC to BNC, (12')</p> <p>BNC to BNC, (40')</p>	<p style="text-align: center;"><u>PART #</u></p> <p>400600-02</p> <p>400600-05</p> <p>400600-08</p> <p>400600-12</p> <p>400600-40</p>	<p style="text-align: center;"><u>AT&T PID #</u></p> <p>ATT.100002467</p> <p>ATT.100002471</p> <p>ATT.100002475</p> <p>ATT.100002481</p> <p>ATT.100002527</p>
<p>DSX-3/4 Patch/Test Cord ("messenger") Wire</p> <ul style="list-style-type: none"> A convenient way of patching Tx & Rx circuits at the same time Available in various lengths 	<p>LCC to BNC, (5')</p> <p>LCC to BNC, (15')</p> <p>LCC to BNC, (30')</p>	<p style="text-align: center;"><u>PART #</u></p> <p>400470B-05</p> <p>400470B-15</p> <p>400470B-30</p>	<p style="text-align: center;"><u>SOUTHEAST</u></p> <p>ATT.100002531</p> <p>ATT.100015137</p> <p>ATT.100015138</p>
	<p>440A to 358A, (12')</p>	<p style="text-align: center;"><u>PART #</u></p> <p>B40358A-12</p>	<p style="text-align: center;"><u>12 STATE</u></p> <p>ATT.100041992</p> <p style="text-align: center;"><u>SOUTHEAST</u></p> <p>ATT.100000775</p>
	<p>358A to 358A, (12')</p>	<p style="text-align: center;"><u>PART #</u></p> <p>B00358A-12</p>	<p style="text-align: center;"><u>12 STATE</u></p> <p>ATT.100038136</p> <p style="text-align: center;"><u>SOUTHEAST</u></p> <p>ATT.100000777</p>
	<p>358A to BNC, (12')</p>	<p style="text-align: center;"><u>PART #</u></p> <p>B00358B-12</p>	<p style="text-align: center;"><u>12 STATE</u></p> <p>ATT.100041987</p> <p style="text-align: center;"><u>SOUTHEAST</u></p> <p>ATT.100000759</p>

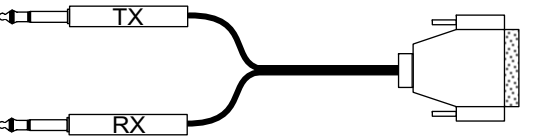
FEATURES / APPLICATION	PART #	DESCRIPTION
<p>Mini-SMB Coax Loopback Tool</p> <ul style="list-style-type: none"> Used to verify Mini-SMB coax cabling when extending FITL equipment 	<p>400632LPT</p> <p>AT&T PID # ATT.100001445</p>	<p>MINI-SMB COAX LOOPBACK TOOL (Female/Male)</p> 
<p>Mini-SMB Coax Loopback Tool</p> <ul style="list-style-type: none"> Used to verify Mini-SMB coax cabling when extending FITL equipment 	<p>400633LPT</p> <p>12 STATE ATT.100071963</p> <p>SOUTHEAST ATT.100001443</p>	<p>MINI-SMB COAX LOOPBACK TOOL (Male)</p> 
<p>Dual 440D Coax Loopback Tool</p> <ul style="list-style-type: none"> Used to verify Dual 440D Coax cabling 	<p>400440LPT</p> <p>12 STATE ATT.100071962</p> <p>SOUTHEAST ATT.100001431</p>	<p>DUAL 440D COAX LOOPBACK TOOL (Female)</p> 
<p>Dual LCC Coax Loopback Tool</p> <ul style="list-style-type: none"> Used to verify Dual LCC Coax cabling 	<p>400470LPT</p> <p>12 STATE Call for Pricing</p> <p>SOUTHEAST ATT.100001439</p>	<p>DUAL LCC COAX LOOPBACK TOOL (Female)</p> 

FEATURES / APPLICATION	PART #	DESCRIPTION
<p>Dual BNC Coax Loopback Tool</p> <ul style="list-style-type: none"> Used to verify Dual BNC Coax cabling 	<p>400600LPT</p> <p>AT&T PID # ATT.100001433</p>	<p>DUAL BNC COAX LOOPBACK TOOL</p>  <p>FRONT BACK</p>
<p>358A Coax Loopback Tool</p> <ul style="list-style-type: none"> Used to verify 358A Coax cabling 	<p>400358LPT</p> <p>AT&T PID # ATT.100001435</p>	<p>358A COAX LOOPBACK TOOL</p> 
<p>Dual Mini-SMB (F) (RA) to Dual BNC, (20')</p> <ul style="list-style-type: none"> Used to extend Coax cabling for IFITL and DFITL ADSL equipment 	<p>400631D-20</p> <p>12 STATE ATT.100041975</p> <p>SOUTHEAST ATT.100001427</p>	<p>DUAL MINI-SMB (Female) (Right Angle) to DUAL BNC</p> 
<p>Dual Mini-SMB (F) (RA) to Dual Mini-SMB (F) (RA), (20')</p> <ul style="list-style-type: none"> Used to extend Coax cabling for IFITL and DFITL ADSL equipment 	<p>400630D-20</p> <p>12 STATE ATT.100053342</p> <p>SOUTHEAST ATT.100001429</p>	<p>DUAL MINI-SMB (Female) (Right Angle) to DUAL MINI-SMB (Female) (Right Angle)</p> 

FEATURES / APPLICATION	PART #	DESCRIPTION		
<p>440A to 440A, (6') - Black 440A to 440A, (2') 440A to 440A, (40')</p> <ul style="list-style-type: none"> • Coax Patch/Test Cord 	<p>400440ABK 400440A-02 400440A-40</p>	<p>440A to 440A</p> 		
<table border="0" style="width: 100%;"> <tr> <td style="width: 50%; background-color: black; color: white; padding: 5px;"> <p>12 STATE ATT.100410630 Call for Pricing Call for Pricing</p> </td> <td style="width: 50%; background-color: black; color: white; padding: 5px;"> <p>SOUTHEAST ATT.100410630 ATT.100002503 ATT.100002537</p> </td> </tr> </table>		<p>12 STATE ATT.100410630 Call for Pricing Call for Pricing</p>	<p>SOUTHEAST ATT.100410630 ATT.100002503 ATT.100002537</p>	<p>6' 2' 40'</p>
<p>12 STATE ATT.100410630 Call for Pricing Call for Pricing</p>	<p>SOUTHEAST ATT.100410630 ATT.100002503 ATT.100002537</p>			
<p>440A to 440A, (6') - Red</p> <ul style="list-style-type: none"> • Coax Patch/Test Cord 	<p>400440ARD</p>	<p>440A to 440A, RED</p> 		
<table border="0" style="width: 100%;"> <tr> <td style="width: 50%; background-color: black; color: white; padding: 5px;"> <p>12 STATE ATT.100053838</p> </td> <td style="width: 50%; background-color: black; color: white; padding: 5px;"> <p>SOUTHEAST ATT.100000785</p> </td> </tr> </table>		<p>12 STATE ATT.100053838</p>	<p>SOUTHEAST ATT.100000785</p>	
<p>12 STATE ATT.100053838</p>	<p>SOUTHEAST ATT.100000785</p>			
<p>440A to BNC, (6') - Black 440A to BNC, (2') 440A to BNC, (4') 440A to BNC, (10')</p> <ul style="list-style-type: none"> • Coax test cord 	<p>400440BBK 400440B-02 400440B-04 400440B-10</p>	<p>440A to BNC</p> 		
<table border="0" style="width: 100%;"> <tr> <td style="width: 50%; background-color: black; color: white; padding: 5px;"> <p>12 STATE ATT.100410640 Call for Pricing Call for Pricing Call for Pricing</p> </td> <td style="width: 50%; background-color: black; color: white; padding: 5px;"> <p>SOUTHEAST ATT.100410640 ATT.100002485 ATT.100015110 ATT.100002491</p> </td> </tr> </table>		<p>12 STATE ATT.100410640 Call for Pricing Call for Pricing Call for Pricing</p>	<p>SOUTHEAST ATT.100410640 ATT.100002485 ATT.100015110 ATT.100002491</p>	<p>6' 2' 4' 10'</p>
<p>12 STATE ATT.100410640 Call for Pricing Call for Pricing Call for Pricing</p>	<p>SOUTHEAST ATT.100410640 ATT.100002485 ATT.100015110 ATT.100002491</p>			
<p>440A to BNC, (6') - Red</p> <ul style="list-style-type: none"> • Coax test cord 	<p>400440BRD</p>	<p>440A to BNC, RED</p> 		
<table border="0" style="width: 100%;"> <tr> <td style="width: 50%; background-color: black; color: white; padding: 5px;"> <p>12 STATE ATT.100053837</p> </td> <td style="width: 50%; background-color: black; color: white; padding: 5px;"> <p>SOUTHEAST ATT.100410650</p> </td> </tr> </table>		<p>12 STATE ATT.100053837</p>	<p>SOUTHEAST ATT.100410650</p>	
<p>12 STATE ATT.100053837</p>	<p>SOUTHEAST ATT.100410650</p>			

FEATURES / APPLICATION	PART #	DESCRIPTION
<p>Porta (non-bridging) to Alligator Clips, (3')</p> <ul style="list-style-type: none"> Test access at Porta type (coils) 	<p>400300SP-03</p> <div style="background-color: black; color: white; padding: 2px; text-align: center; font-weight: bold;"> AT&T PID # ATT.100001293 </div>	<p>PORTA to ALLIGATOR CLIPS</p> 
<p>Bantam "Y" (Tx & Rx) to RJ48C- (T1), (8')</p> <ul style="list-style-type: none"> Commonly used to Transmit (TX) and Receive (RX) from T1 tests The RJ48C plugs into the faceplate of T1 cards allowing test access 	<p>400248-08</p> <div style="background-color: black; color: white; padding: 2px; text-align: center; font-weight: bold;"> AT&T PID # ATT.100000707 </div>	<p>BANTAM "Y" to RJ48C</p> 
<p>Bantam "Y" (Tx & Rx) to RJ48S - (DDS), (8')</p> <ul style="list-style-type: none"> Commonly used to Transmit (TX) and Receive (RX) from DDS tests The RJ48S plugs into the faceplate of DDS cards allowing test access 	<p>400248S</p> <div style="background-color: black; color: white; padding: 2px; text-align: center; font-weight: bold;"> AT&T PID # ATT.100000735 </div>	<p>BANTAM "Y" to RJ48S</p> 
<p>310 "Y" (Tx & Rx) to 15 Pin D (male), (4')</p> <ul style="list-style-type: none"> Commonly used to Transmit (TX) and Receive (RX) from Customer Service Unit (CSU) from T1 test sets 3101596 Also used with T1 power lids 	<p>400315M-04</p> <div style="background-color: black; color: white; padding: 2px; text-align: center; font-weight: bold;"> AT&T PID # ATT.100000761 </div>	<p>310 "Y" to 15 PIN D (male)</p> 
<p>RJ48 (T1) to 4 Alligator Clips, (6')</p> <ul style="list-style-type: none"> 597243 Alligator Clip Access to RJ48 (Pins 1,2,4,5) 	<p>400448A4-06</p> <div style="background-color: black; color: white; padding: 2px; text-align: center; font-weight: bold;"> AT&T PID # ATT.100000647 </div>	<p>RJ48 (T1) to 4 ALLIGATOR CLIPS</p> 

FEATURES / APPLICATION	PART #	DESCRIPTION
<p>Cord Test Shoe - Dual Plug (327) to 463A, (16')</p> <ul style="list-style-type: none"> • Frame Cord 	<p>T-W4BR-16</p> <div style="background-color: black; color: white; padding: 2px; text-align: center; margin-top: 5px;"> AT&T PID # ATT.100035140 </div>	<p style="text-align: center;">DUAL 310 (327) to PROTECTOR</p> 
<p>Cord Test Shoe - Dual Plug (327) to Porta, (16')</p> <ul style="list-style-type: none"> • Frame Cord 	<p>T-W4BR-P</p> <div style="background-color: black; color: white; padding: 2px; text-align: center; margin-top: 5px;"> AT&T PID # ATT.100409620 </div>	<p style="text-align: center;">DUAL 310 (327) to PORTA</p> 
<p>Cord Test Shoe - Dual Plug (327) to 252A/B, (16')</p> <ul style="list-style-type: none"> • Frame Cord 	<p>T-4W6A-16</p> <div style="background-color: black; color: white; padding: 2px; text-align: center; margin-top: 5px;"> AT&T PID # ATT.100409630 </div>	<p style="text-align: center;">DUAL 310 (327) to 252A/B</p> 
<p>Cord Test Shoe - Dual Plug (327) to 412A/B, (16')</p> <ul style="list-style-type: none"> • Frame Cord 	<p>T-4W11A-16</p> <div style="background-color: black; color: white; padding: 2px; text-align: center; margin-top: 5px;"> AT&T PID # ATT.100409640 </div>	<p style="text-align: center;">DUAL 310 (327) to 412A/B</p> 
<p>Cord Test Shoe - Dual Plug (327) to Wire Wraps, (16')</p> <ul style="list-style-type: none"> • Frame Cord 	<p>400327WP-16</p> <div style="background-color: black; color: white; padding: 2px; text-align: center; margin-top: 5px;"> AT&T PID # ATT.100035129 </div>	<p style="text-align: center;">DUAL 310 (327) to WIRE WRAPS</p> 

FEATURES / APPLICATION	PART #	AT&T PID #	DESCRIPTION
------------------------	--------	------------	-------------

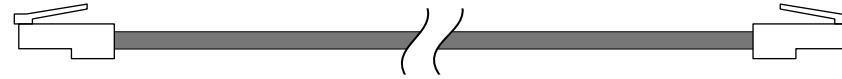

AT&T PID #

Cat 5 Cable (RJ45 to RJ45), (10')	RH-CAT5-10	ATT.100111579	CAT 5 CABLES (RJ45 to RJ45) (@ various lengths)
Cat 5 Cable (RJ45 to RJ45), (15')	RH-CAT5-15	ATT.100000977	
Cat 5 Cable (RJ45 to RJ45), (20')	RH-CAT5-20	ATT.100000979	
Cat 5 Cable (RJ45 to RJ45), (25')	RH-CAT5-25	ATT.100000981	
Cat 5 Cable (RJ45 to RJ45), (30')	RH-CAT5-30	ATT.100000983	
Cat 5 Cable (RJ45 to RJ45), (40')	RH-CAT5-40	ATT.100000985	
Cat 5 Cable (RJ45 to RJ45), (50')	RH-CAT5-50	ATT.100111581	
Cat 5 Cable (RJ45 to RJ45), (75')	RH-CAT5-75	ATT.100111583	
Cat 5 Cable (RJ45 to RJ45), (100')	RH-CAT5-100	ATT.100000991	
Cat 5 Cable (RJ45 to RJ45), (125')	RH-CAT5-125	ATT.100412390	
Cat 5 Cable (RJ45 to RJ45), (150')	RH-CAT5-150	ATT.100000995	
Cat 5 Cable (RJ45 to RJ45), (200')	RH-CAT5-200	ATT.100412400	
Cat 5 Cable (RJ45 to RJ45), (250')	RH-CAT5-250	ATT.100412410	

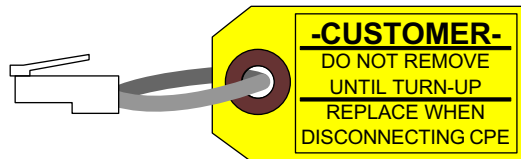

PN # 400448LP
Temporary RJ48 Looping Plug
AT&T PID # ATT.100000561

- Used to loop "Smart Jack" to provide a physical loop

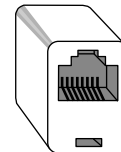

PN # RJ48-C
RJ48 Coupler
AT&T PID # ATT.100035173

- General purpose adapter

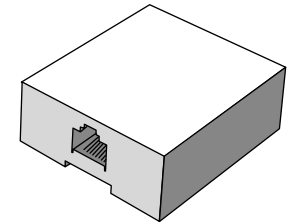

PN # RH-RJ48FMB
RJ48 Female Mounting Block
12 STATE ATT.100008970
SOUTHEAST ATT.100001013

- General purpose adapter

Remote Network Cable Tester w/ Tone Generator

CAT-107G

Simplify Network Cable Testing !!

Cable Test Features:

- Displays:**
- Short
 - Reversed
 - Miswired
 - Split Pairs

Tone Generator* Features:

- Verification of Shield Integrity
- Puts Tracer Tone on Cable

* Tone Generator function requires customer supplied Cable Tracing Probe

Additional Features:

- Specially designed Remote Unit that enables one person to test installed cables
- Easy to read Fault Display and high speed testing
- Debug mode for detailed fault identification results
- Auto Sleep Mode and Power Off Switch to decrease power consumption
- Low Battery Indicator
- Includes (4) four AAA batteries

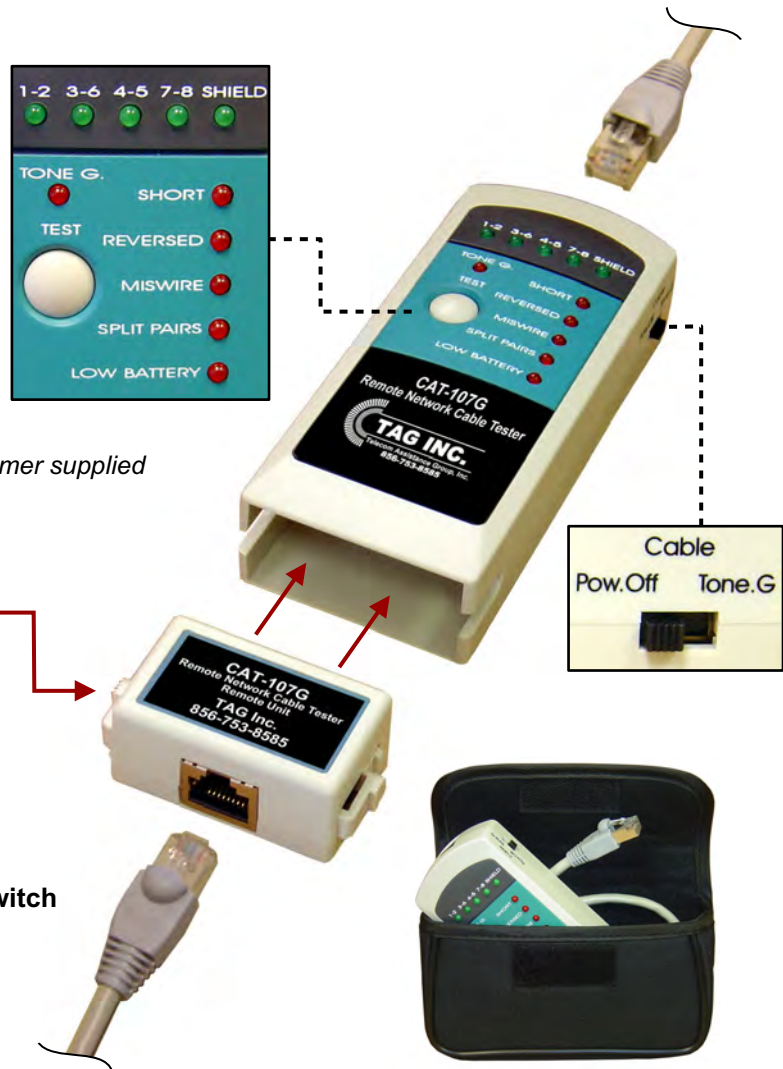

Includes: Soft Vinyl Carrying Pouch & Remote Terminating Cable

Application:

The CAT-107G is a small hand-held cable tester, which enables network professionals to quickly and easily verify the integrity of ethernet twisted pair cables for open pairs, shorted pairs, reversed pairs, crossed pairs and split pairs. Push the TEST button and the CAT-107G will automatically scan for any existing faults in your cable. The specially designed remote terminator is provided for one-person testing of installed cables. The tone generator function can be used to send a signal through installed cables which can be traced with most cable tracers on the market.

Ordering Information:

CAT-107G Remote Network Cable Tester w/ Tone Generator
includes: (1) Carrying Pouch, (1) Remote Terminating Cable & (4) AAA Batteries

AT&T PID #
ATT.100035180

150 Cooper Rd. (F-15)
W. Berlin, NJ 08091

www.tagcords.com

Telephone: (856) 753-8585
Fax : (856) 768-7645

Telecom Assistance Group

"Green Coil Cord"**400300FP****"Frogger" Protector Test Cord, (20')**

1. Insert "Good" (green) plug into known good line.
2. Insert "Bad" (red) plug into bad line for temporary restoration.

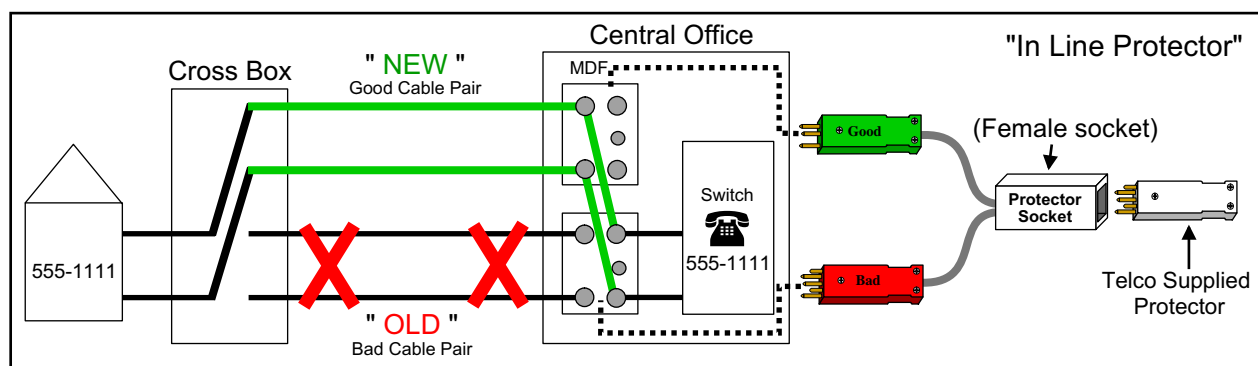
**Application:**

TAG's Temporary Restoral Cord (400300FP) allows you to add protection back to the telephone line when testing. TAG's test cord features a built-in protector socket that accepts any 5-pin protector module. A 5-pin module with the same specifications as the line you are testing on must be inserted before the test cord can function. Once inserted, the cord will now function and protection has been restored to the line.

In the event of a power or lightning strike, TAG's 400300FP can save thousands of dollars by eliminating dangers that can destroy expensive equipment or possibly harm a technician. One plug is Green "GOOD" & the other plug is Red "BAD". When the repair is made, the circuit can be identified as to which pair is good or bad.

Ordering Information:**400300FP****"Frogger" Protector Test Cord - (20')****AT&T PID #****ATT.100111566**

150 Cooper Rd. (F-15)
W. Berlin, NJ 08091

www.tagcords.com

Telephone: (856) 753-8585
Fax : (856) 768-7645

Telecom Assistance Group

DB9M / RS232 to USB Adapter Cable

Need access to a Serial Port on your Laptop?

TAG's Adapter Cable will convert your Laptop's USB Port into a Serial Port!

Serial Port on an Older Laptop

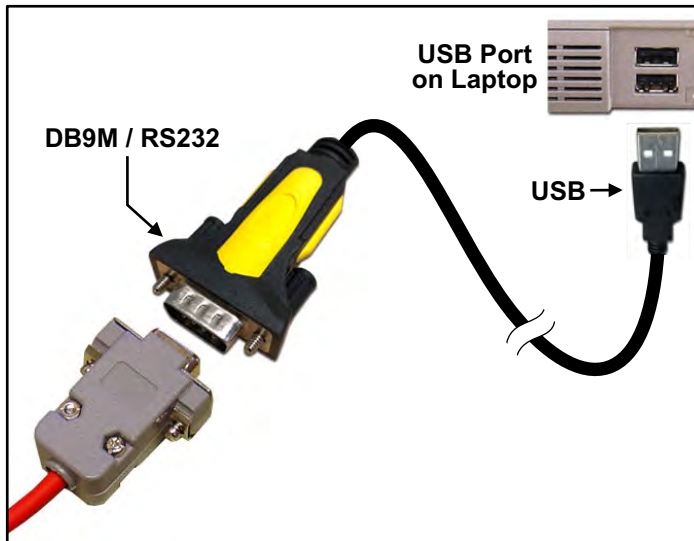
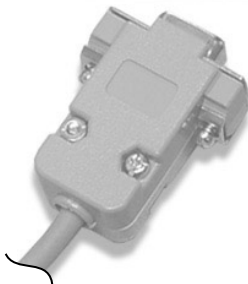

System Requirements:

- Supports Windows® 2000 / XP / Server 2008 / Vista / 7 / 8 / 10
- Available USB Port

Application:

Plug the USB connector into your computer and the serial connector into your serial device to exchange files, data and more.



Ordering Information:

400720USB DB9M/RS232 to USB Adapter Cable
Supports Windows® 2000 / XP / Server 2008 / Vista / 7 / 8 / 10

AT&T PID #
ATT.100000993

150 Cooper Rd. (F-15)
 W. Berlin, NJ 08091

www.tagcords.com

Telephone: (856) 753-8585
 Fax : (856) 768-7645

Telecom Assistance Group

USB-C to DB9 Pin (male)

400721USBC

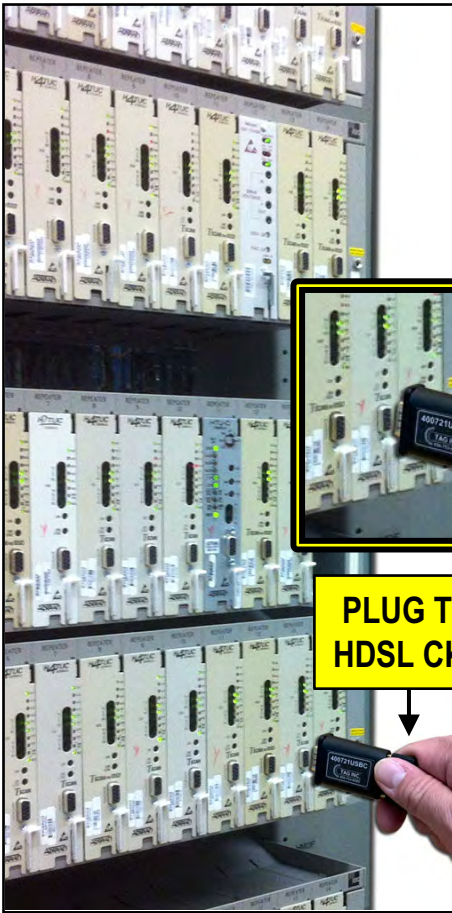

PLUG TO USB-C PORT ON LAPTOP



Ordering Information:

400721USBC

USB-C to DB9 Pin (male)

AT&T PID #

ATT.200009155

150 Cooper Rd. (F-15)
W. Berlin, NJ 08091

www.tagcords.com

Telephone: (856) 753-8585
Fax : (856) 768-7645

Telecom Assistance Group

Multi Function 800 Drop & Insert

400828DI

Four (4) Test Cord Functions:

- White "Near Side"
- Blue "Far Side"
- Orange "Monitor"
- Drop & Insert

In One Test Unit

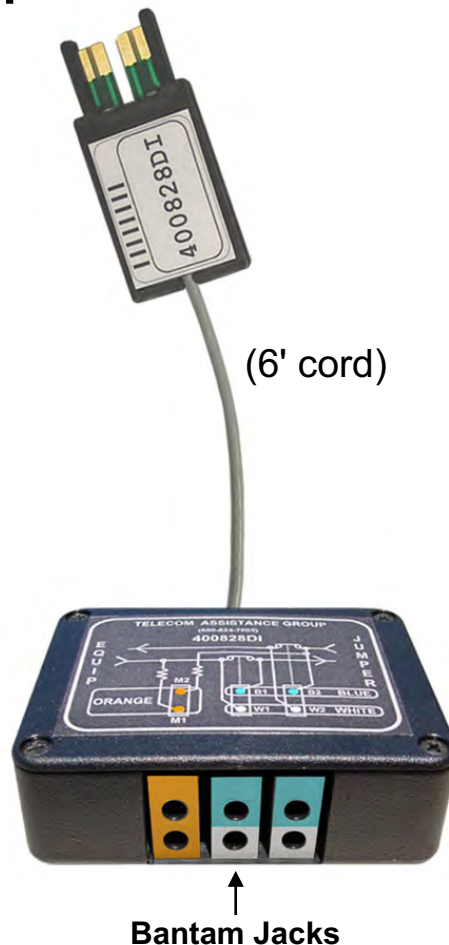
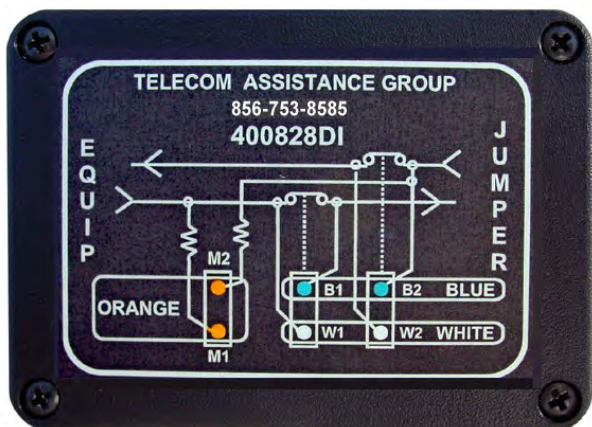

Application:

Telecom Assistance Group's multi-function 800 DSX unit combines four (4) test cord functions in one unit. The 400828DI eliminates the need for Orange, White, Blue cords in various lengths and also provides versatile Drop & Insert capabilities. **Drop & Insert** functions can be **performed at one 800 DSX jackfield** - never have to locate Test Set and use 2 long test cords.

Ordering Information:

400828DI Multi-Function 800 DSX Unit/Test Cord, (6')
 B004210TP-100 Bantam Terminating Plug (100 ohm)

12 STATE **SOUTHEAST**
 ATT.100079126 ATT.100011515
 ATT.100038211 ATT.100000599

400210RD Bantam to Bantam - RED, (6')
 400210BK Bantam to Bantam - BLACK, (6')

AT&T PID #
 ATT.100068132
 ATT.100408970

150 Cooper Rd. (F-15)
 W. Berlin, NJ 08091

www.tagcords.com

Telephone: (856) 753-8585
 Fax : (856) 768-7645

Telecom Assistance Group

800 DSX Flasher

408800FL

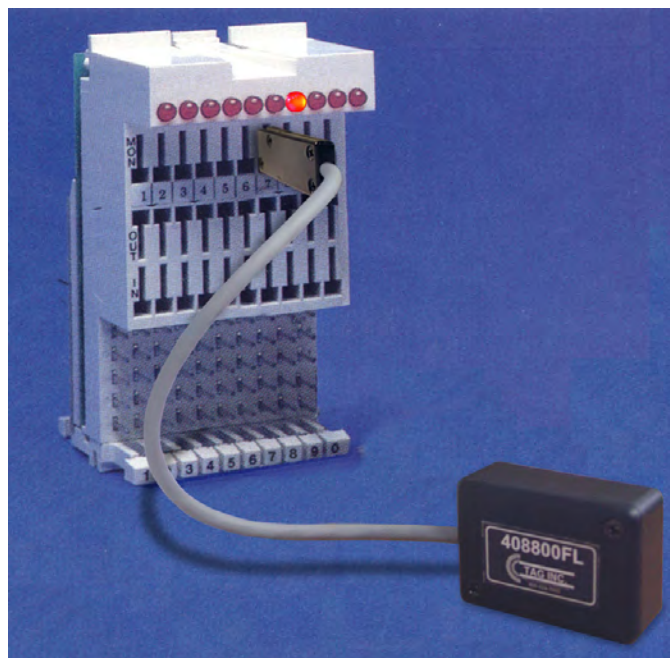

Application:

The 408800FL (800 DSX Flasher cord) is used for jumper tracing. Insert the 408800FL into the monitor jack to "flash" the corresponding 800 DSX jacks.

Ordering Information:

408800FL 800 DSX Flasher

AT&T PID #

ATT.100001015

150 Cooper Rd. (F-15)
W. Berlin, NJ 08091

www.tagcords.com

Telephone: (856) 753-8585
Fax : (856) 768-7645

Telecom Assistance Group

ADSL Test Cord

400548ADSL

Protector to RJ48 "Y" - 6' (ADSL)

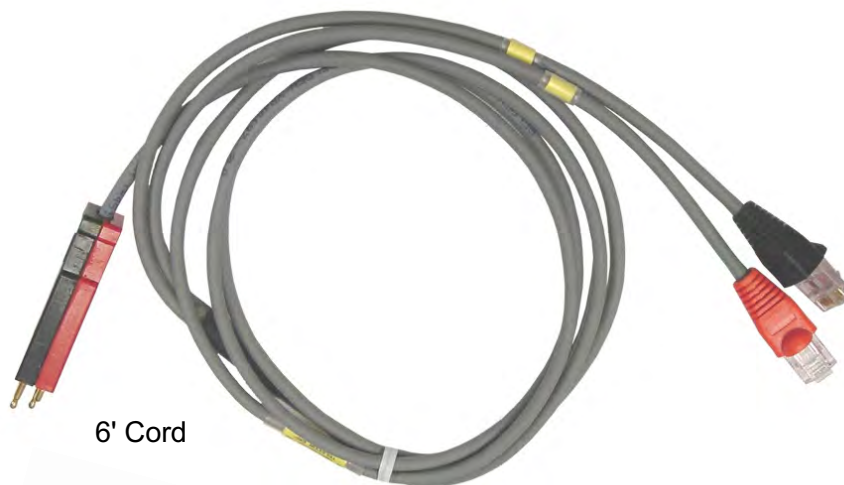

6' Cord

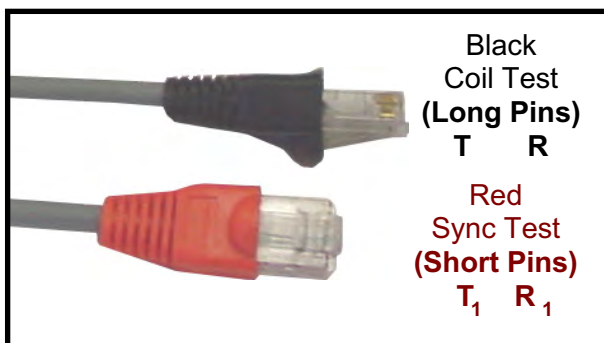
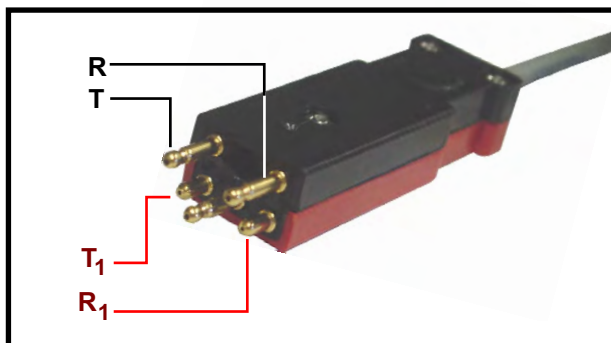

WIRING NOTES:

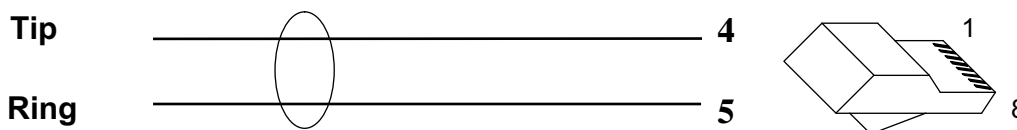

Application:

Used with Sunrise ADSL Test Set.
 Plug Red RJ48 in test set to perform Sync Test.
 Plug Black RJ48 in test set to perform Coil Test.

Ordering Information:

400548ADSL

ADSL Test Cord, (6')

12 STATE

ATT.100041974

SOUTHEAST

ATT.100000779

150 Cooper Rd. (F-15)
 W. Berlin, NJ 08091

www.tagcords.com

Telephone: (856) 753-8585
 Fax : (856) 768-7645

Telecom Assistance Group

Test Cords

CATENA



400722ADSL

9 Pin D (Female) to RJ45, (6')

Application:

Used from Laptop (9 pin male on Laptop) to Catena Network ADSL card (RJ45 jack on card)

AT&T PID #

ATT.10000601

DMX CROSS-OVER



400448XP-10

DMX Provisioning (CAT5E)
Cross-Over Cable, (10')

Application:

TAG's 400448XP-10 is used for testing Lucent's DMX Platforms with the CAT5E Ethernet Cable. The CAT5E cable is designed to work with Windows XP operating systems.

12 STATE

ATT.100038423

SOUTHEAST

ATT.100012551



400740-10

DB 9 Pin (female) to RJ45, (10')

Application:

Used from Laptop (9 pin male on Laptop) to Edgelink 100 panel (RJ45 jack on panel).

12 STATE

ATT.100041983

SOUTHEAST

ATT.100000645

150 Cooper Rd. (F-15)
W. Berlin, NJ 08091

www.tagcords.com

Telephone: (856) 753-8585
Fax : (856) 768-7645

Telecom Assistance Group

DSL Breakout Box

400459DSL

Protector to DSL Breakout Box

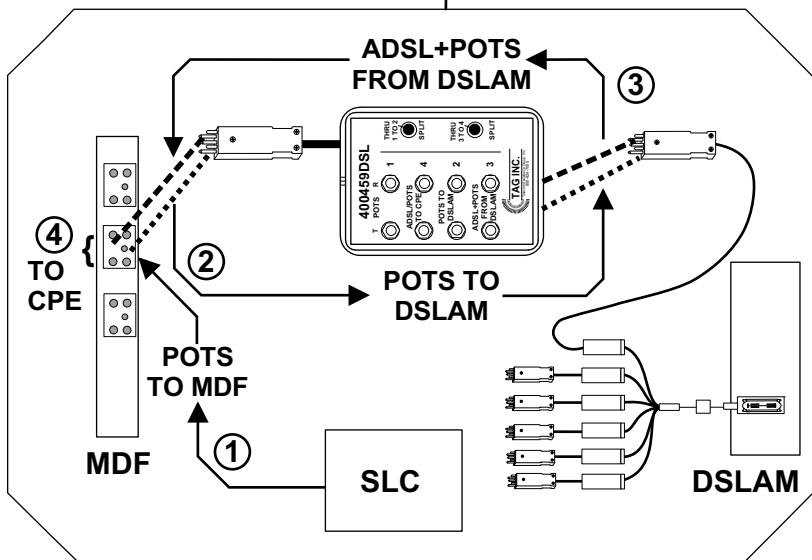
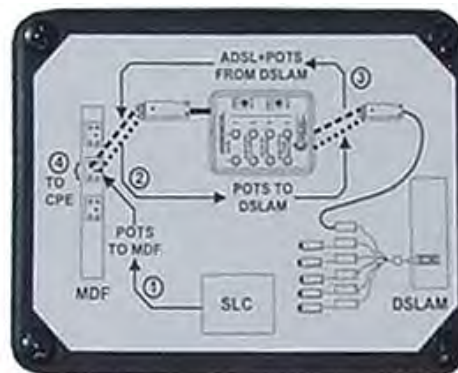

Application:

Telecom Assistance Group's 400459DSL breakout box is used so that ADSL technicians can isolate DSL troubles at DSLAM locations.

Ordering Information:

400459DSL Protector to DSL Breakout Box, (3')

12 STATE

SOUTHEAST

ATT.100041973

ATT.100011625

150 Cooper Rd. (F-15)
W. Berlin, NJ 08091

www.tagcords.com

Telephone: (856) 753-8585
Fax : (856) 768-7645

Telecom Assistance Group

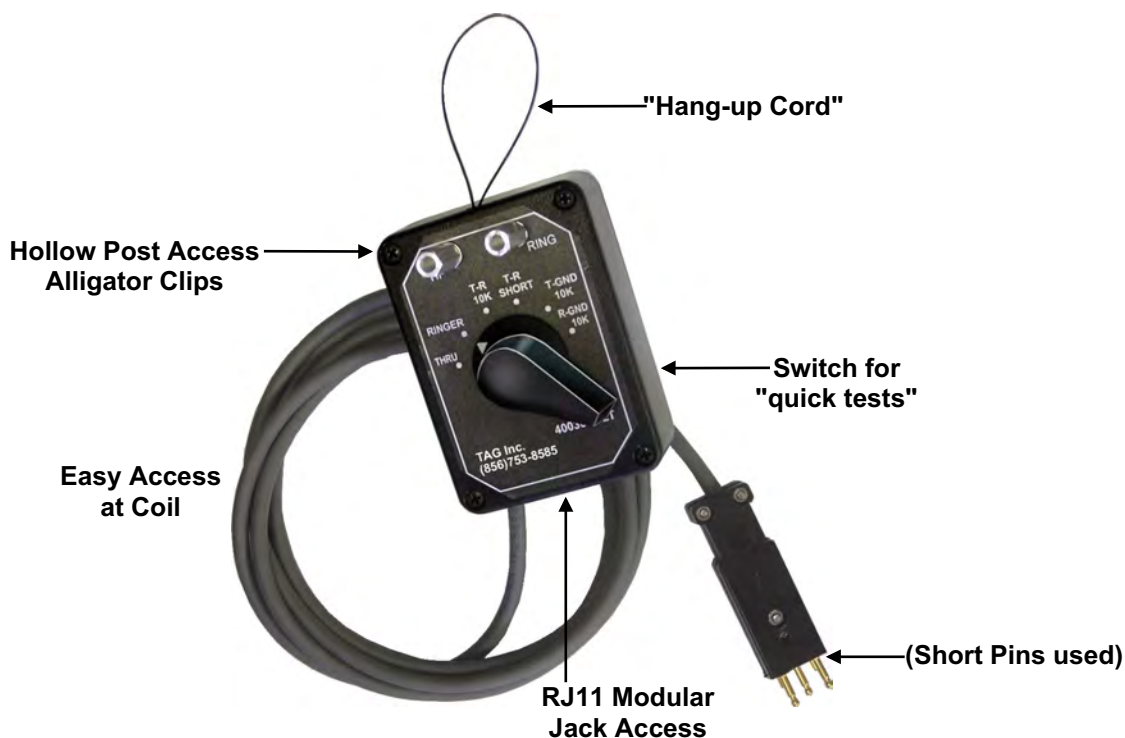
MLT Load / Test Box**400300MLT**

TAG's MLT Load/Test Box (400300MLT) provides a convenient and easy means to **Test** with **MLT** on **New Installs** and **Calibrate "Loop Resistance"**.

Simply plug the MLT Load/Test Box on the circuit to test with MLT. Establish communication with a MLT tester to verify results.

Note: TAG offers a "Hands Free" Telephone Set - Model WT-1K for added convenience. A sturdy switch on the MLT Load/Test Box allows selecting the following tests:

- Tip to Ring Short
- Ring to Ground (10K)
- Tip to Ring Load (10K)
- Ringer Test Load (>.75A)
- Tip to Ground (10K)
- Thru to Hollow Posts and RJ11 (just in case)

The MLT Load/Test Box plugs to various interface points for ease of testing with MLT. The 400300MLT can be equipped with "coil access" at the RT, RJ11 access at the NID or Alligator Clips for general purpose.

Ordering Information:**400300MLT****Cord Protector MLT Test Box, (6')****AT&T PID #****ATT.100000953**

150 Cooper Rd. (F-15)
W. Berlin, NJ 08091

www.tagcords.com

Telephone: (856) 753-8585
Fax : (856) 768-7645

Telecom Assistance Group

DS1 Disconnect Clean Up Cord, (10')

400210WB-10

DSX JACK PANEL

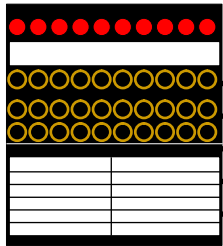

**(WIRE WRAPS)
TIE PAIR BLOCK**

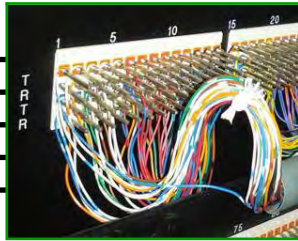

**(WIRE WRAPS)
TIE PAIR BLOCK**

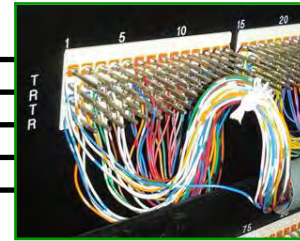

DSX JACK PANEL

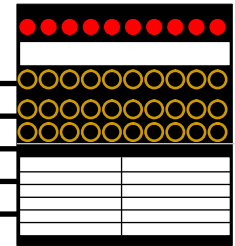

Application:

- DSX test cord plugs on the DSX Tie Pair Blocks to verify back-logged DS1 disconnects. With shorthanded staff you can quickly verify traffic on each tie pair disconnect.
- **Problem:** Tie pair blocks are full and need to re-use.
- **Solution:** Use TAG's PN # 400210WB-10 along with a T-Berd to verify DS1 traffic on each tie pair.

400210WB-10
Bantam to Wire Wrap Terminals
"Monitor", (10')
(DS1 Disconnect Clean Up Cord)

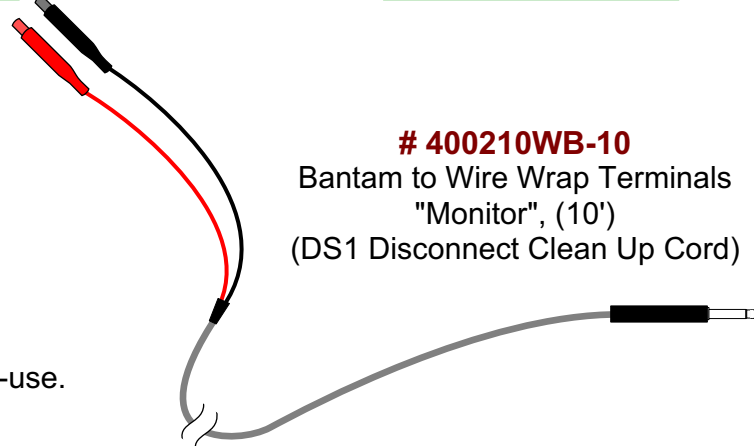

T-BERD*
(not included)

Ordering Information:		AT&T PID #
400210WB-10	Bantam to Wire Wrap Terminals "Monitor", (10') (DS1 Disconnect Clean Up Cord)	ATT.100090491

150 Cooper Rd. (F-15)
W. Berlin, NJ 08091

www.tagcords.com
Telecom Assistance Group

Telephone: (856) 753-8585
Fax : (856) 768-7645

Fluke CopperPro 990* Cord Kit

KIT-CP990-BST

**Kit Designed for
CopperPro* Test Set &
Far End Device**

Fluke Plug (RJ45) to
Blue 463A/Red 463A/Gnd, (6')
Part # FL-FED463G

12 STATE
ATT.100042001

SOUTHEAST
ATT.100011869



****Fluke TN2100
& CopperPro
not included****



**INCLUDES
CARRYING
CASE**

8 Pouch Carrying Case
Part # TCC-001

12 STATE
ATT.100071979

SOUTHEAST
ATT.100001659

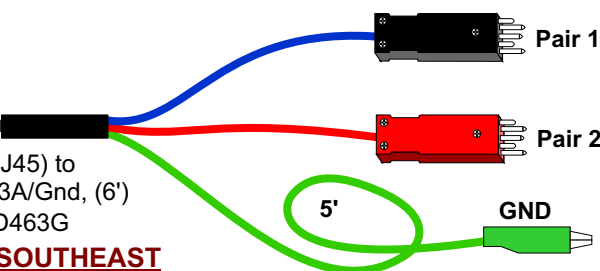

Fluke to 463A Protector (Blue), (6')
Part # FL-400100SBY

12 STATE: ATT.100041997 **SOUTHEAST: ATT.100011855**

Fluke to 463A Protector (Red), (6')
Part # FL-400100SRD

12 STATE: ATT.100041998 **SOUTHEAST: ATT.100011857**

Fluke to Wire Wraps (Blue), (6')
Part # FL-400100WPBY

12 STATE: ATT.100040056 **SOUTHEAST: ATT.100011845**

Fluke to Wire Wraps (Red), (6')
Part # FL-400100WPRD

12 STATE: ATT.100041999 **SOUTHEAST: ATT.100011847**

Fluke to Bantam (Blue), (6')
Part # FL-400100BBY

12 STATE: ATT.100041996 **SOUTHEAST: ATT.100011849**

Fluke to Bantam (Red), (6')
Part # FL-400100BRD

12 STATE: ATT.100041995 **SOUTHEAST: ATT.100011851**

Ground Cord, (8')
Part # FL-400409

12 STATE: ATT.100042000 **SOUTHEAST: ATT.100011811**

Ordering Information:

KIT-CP990-BST **Fluke CopperPro 990* Cord Kit**

includes: (1) FL-FED463G, (1) FL-400100SBY, (1) FL-400100SRD,
(1) FL-400100WPBY, (1) FL-400100WPRD, (1) FL-400100BBY,
(1) FL-400100BRD, (1) FL-400409 & (1) TCC-001

12 STATE (KIT)
ATT.100071967

SOUTHEAST (KIT)
ATT.100011885

150 Cooper Rd. (F-15)
W. Berlin, NJ 08091

www.tagcords.com

Telephone: (856) 753-8585
Fax : (856) 768-7645

Telecom Assistance Group

JDSU HST-3000* Test Cords

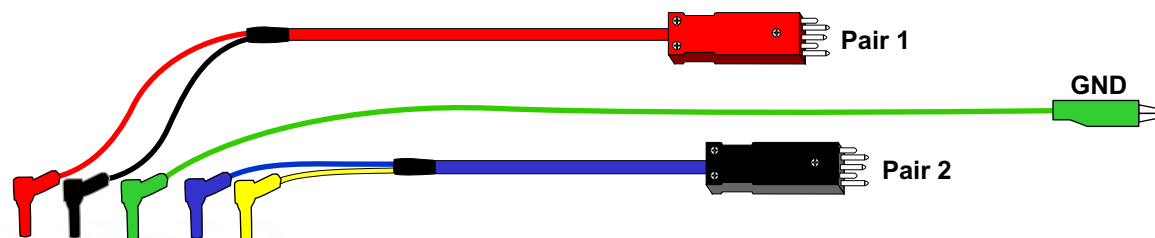

****JDSU
HST-3000 Test Set
not included****



8 Pouch Carrying Case
Part # TCC-001

12 STATE **SOUTHEAST**
ATT.100071979 **ATT.100001659**

<p>Mini Bananas to 463A Protector (Blue), (6') Part # FL-400100SBY</p> <p>12 STATE: ATT.100041997 SOUTHEAST: ATT.100011855</p>
<p>Mini Bananas to 463A Protector (Red), (6') Part # FL-400100SRD</p> <p>12 STATE: ATT.100041998 SOUTHEAST: ATT.100011857</p>
<p>Mini Bananas to Wire Wraps (Blue), (6') Part # FL-400100WPBY</p> <p>12 STATE: ATT.100040056 SOUTHEAST: ATT.100011845</p>
<p>Mini Bananas to Wire Wraps (Red), (6') Part # FL-400100WPRD</p> <p>12 STATE: ATT.100041999 SOUTHEAST: ATT.100011847</p>
<p>Mini Bananas to Bantam (Blue), (6') Part # FL-400100BBY</p> <p>12 STATE: ATT.100041996 SOUTHEAST: ATT.100011849</p>
<p>Mini Bananas to Bantam (Red), (6') Part # FL-400100BRD</p> <p>12 STATE: ATT.100041995 SOUTHEAST: ATT.100011851</p>
<p>Ground Cord, (8') Part # FL-400409</p> <p>12 STATE: ATT.100042000 SOUTHEAST: ATT.100011811</p>

150 Cooper Rd. (F-15)
W. Berlin, NJ 08091

www.tagcords.com

Telephone: (856) 753-8585
Fax : (856) 768-7645

Telecom Assistance Group

xDSL Test Set Multi-Cord

400253JSA

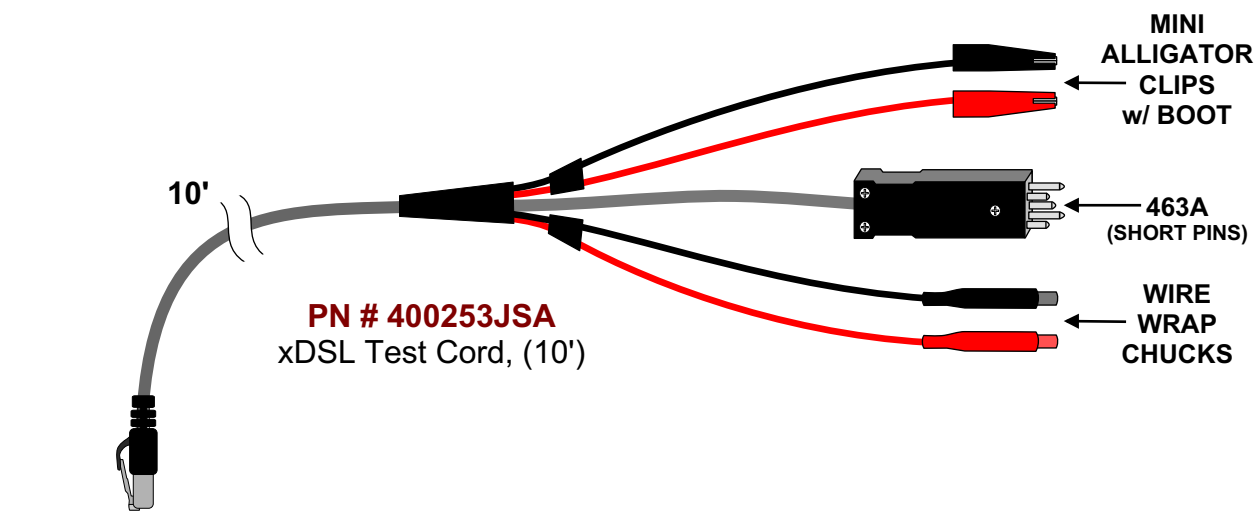

Spirent Tech-X-Flex
DSL Test Set**
(not included)



**JDSU Smart Class*
xDSL Test Set**
(not included)

Application:

The TAG PN # 400253JSA test cord is commonly used with the JDSU Smart Class* xDSL or the Spirent Tech-X-Flex** DSL test set.

Ordering Information:

400253JSA

xDSL Test Set Multi-Cord, (10')

AT&T PID

ATT.100050939

150 Cooper Rd. (F-15)
W. Berlin, NJ 08091

www.tagcords.com

Telephone: (856) 753-8585
Fax : (856) 768-7645

Telecom Assistance Group

Megalink Cord Kit

KIT-T1



(1) 8 Pouch Carrying Case
TCC-001

Test Cord Kit for Megalink Test Sets

(2) Female Bantam to Alligator Clips, (1')
400200F-01



(1) Bantam to Bantam (15') Red, # 400210RD-15
(1) Bantam to Bantam (15') Black, # 400210BK-15

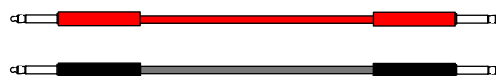

(2) Female Bantam to Wire Wraps, (1')
400200FWP-01



(1) Bantam "Y" to RJ48 (T1), (8')
400248Y



(2) Female Bantam to 800 DSX (Thin), (1')
408210FT



(2) Bantam to 310 Conversion Plug
400239BST

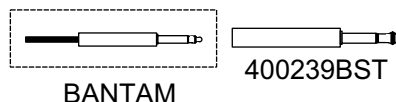

(1) RJ48 to RJ48, (6')
400448



(1) Protector to Alligator Clips, (3')
400300RG-03



Ordering Information:

KIT-T1 Megalink Cord Kit

includes: (2) 400200F-01, (2) 400200FWP-01, (2) 408210FT, (1) 400448, (1) 400210RD-15,
(1) 400210BK-15, (1) 400248Y, (2) 400239BST, (1) 400300RG-03 & (1) TCC-001

AT&T PID #
ATT.100001191

150 Cooper Rd. (F-15)
W. Berlin, NJ 08091

www.tagcords.com

Telephone: (856) 753-8585
Fax : (856) 768-7645

Telecom Assistance Group

Bantam Cord Kit

KIT-BANT



Test Cord Kit for Test Sets with Bantam Jacks

(1) 8 Pouch Carrying Case
TCC-001

(1) Bantam to Alligator Clips (8') Red, # 400210ARD-08
(1) Bantam to Alligator Clips (8') Black, # 400210ABK-08

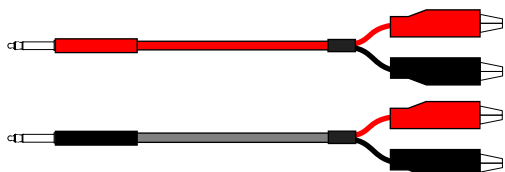

(1) Bantam to Wire Wraps (8') Red, # 400210WPR-08
(1) Bantam to Wire Wraps (8') Black, # 400210WPB-08

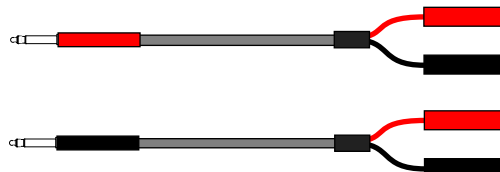

(1) RJ48 to RJ48 (T1), (6')
400448



(1) Bantam "Y" to RJ48S (DDS), (8')
400248SY



(1) Bantam to Bantam (8') Red, # 400210RD-08
(1) Bantam to Bantam (8') Black, # 400210BK-08



(1) Bantam "Y" to RJ48 (T1), (8')
400248Y



(1) Bantam to 310 (8'), Red
400310MRD-08



(1) Bantam to 310 (8'), Black
400310MBK-08



Ordering Information:

KIT-BANT Bantam Cord Kit

includes: (1) 400210ARD-08, (1) 400210ABK-08, (1) 400210WPR-08,
(1) 400210WPB-08, (1) 400448, (1) 400248SY, (1) 400248Y, (1) 400210RD-08,
(1) 400210BK-08, (1) 400310MRD-08, (1) 400310MBK-08 & (1) TCC-001

12 STATE

ATT.100071966

SOUTHEAST

ATT.100000967

150 Cooper Rd. (F-15)
W. Berlin, NJ 08091

www.tagcords.com

Telephone: (856) 753-8585
Fax : (856) 768-7645

Telecom Assistance Group

VIP Sidekick Module Replacement Cord for IFD, (6')

SBC400190

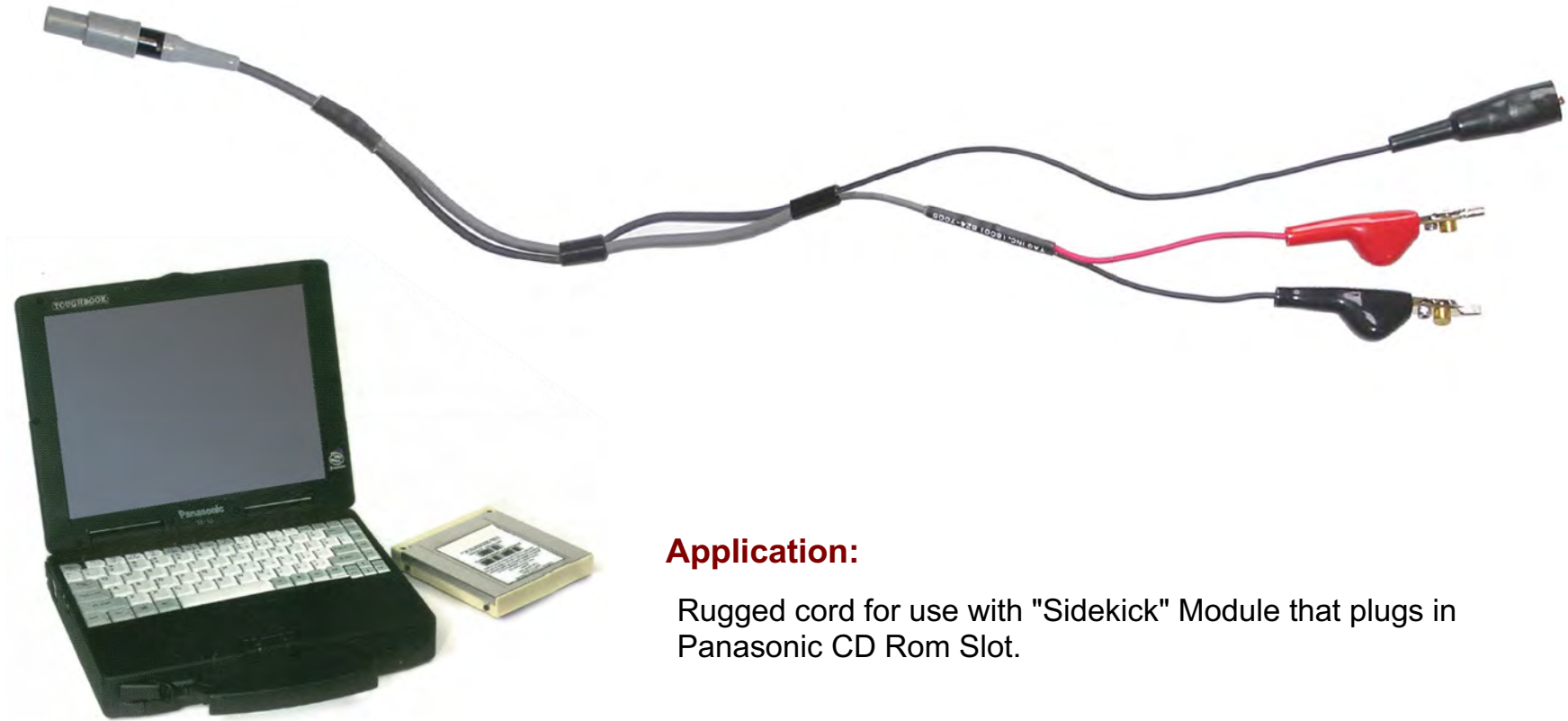

Application:

Rugged cord for use with "Sidekick" Module that plugs in Panasonic CD Rom Slot.

Ordering Information

SBC400190 **VIP Sidekick Module Replacement Cord for IFD, (6')**

AT&T PID

ATT.100408520

150 Cooper Rd. (F-15)
W. Berlin, NJ 08091

www.tagcords.com
Telecom Assistance Group

Telephone: (856) 753-8585
Fax : (856) 768-7645

DLC Cord Kit

DLC-KITBST



(1) # TCC-001 - 8 Pouch Carrying Case
12 STATE: ATT.100071979 SOUTHEAST: ATT.100001659

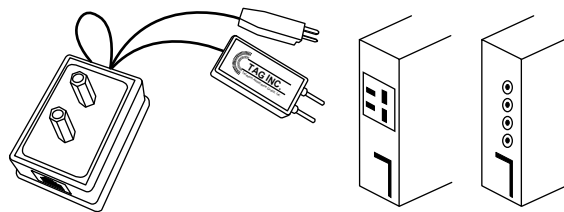

(1) # 4003956 - "The Slick Cord" - Series 5 & SLC 96
AT&T PID #: ATT.100000821



(2)* # 400210A - Bantam to (2) Alligator Clips, (6')
12 STATE: ATT.100038299 SOUTHEAST: ATT.100000681



(1) # 400703-25 - 9 Pin (f) to 25 Pin (m), (25')
12 STATE: ATT.100041977 SOUTHEAST: ATT.100000733



(2)* # 408210 - Bantam to 800 DSX, (6')
AT&T PID #: ATT.100000815



(1) # 400722ADSL - Catena DB 9 Pin (f) to RJ45, (6')
AT&T PID #: ATT.100000601



(2)* # 400210WP - Bantam to Wire Wraps, (6')
AT&T PID #: ATT.100000799



(1) # 400720 - DB 9 Pin (m) to DB 9 Pin (f), (6')
12 STATE: ATT.100041957 SOUTHEAST: ATT.100000571

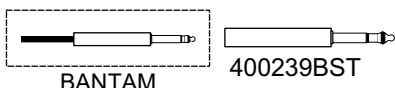

(2)* # 400239BST - Bantam to 310 Conversion Plug
12 STATE: ATT.100035887 SOUTHEAST: ATT.100000515



(1) # 400703H-25 - DB 9 Pin (m) to 25 Pin (m), (25')
12 STATE: ATT.100041981 SOUTHEAST: ATT.100000649



(1) # 400440BLP - BNC Loopback Cord, (9")
AT&T PID #: ATT.100000565

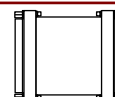

(1) # 400725N - 25 Pin (m) to 25 Pin (f) "NULL" Adapter
12 STATE: ATT.100041982 SOUTHEAST: ATT.100000505



(1) # 400210BK - Bantam to Bantam, RX - Black, (6')
AT&T PID #: ATT.100408970



(1) #400448XP-10 - DMX Provisioning (CAT5E) Cable, (10')
12 STATE: ATT.100038423 SOUTHEAST: ATT.100012551



(1) # 400210RD - Bantam to Bantam, TX - Red, (6')
AT&T PID #: ATT.100068132



(1) # 400448-06 - RJ48 to RJ48, (6')
12 STATE: ATT.100041971 SOUTHEAST: ATT.100000573

Ordering Information:

DLC-KITBST DLC Cord Kit

includes: (2) 400210A, (1) 400210BK, (1) 400210RD, (2) 408210, (1) 400720, (2) 400210WP, (2) 400239BST, (1) 4003956, (1) 400725N, (1) 400703-25, (1) 400448XP-10, (1) 400440BLP, (1) 400703H-25, (1) 400722ADSL, (1) 400448-06 & (1) TCC-001

**12 STATE (KIT)
 ATT.100038417**

**SOUTHEAST (KIT)
 ATT.100001189**

*** When ordering individual PID items, quantity received will be one (1)***

150 Cooper Rd. (F-15)
 W. Berlin, NJ 08091

Telephone: (856) 753-8585
 Fax : (856) 768-7645

www.tagcords.com

Telecom Assistance Group

T1 Monitor Box

400820

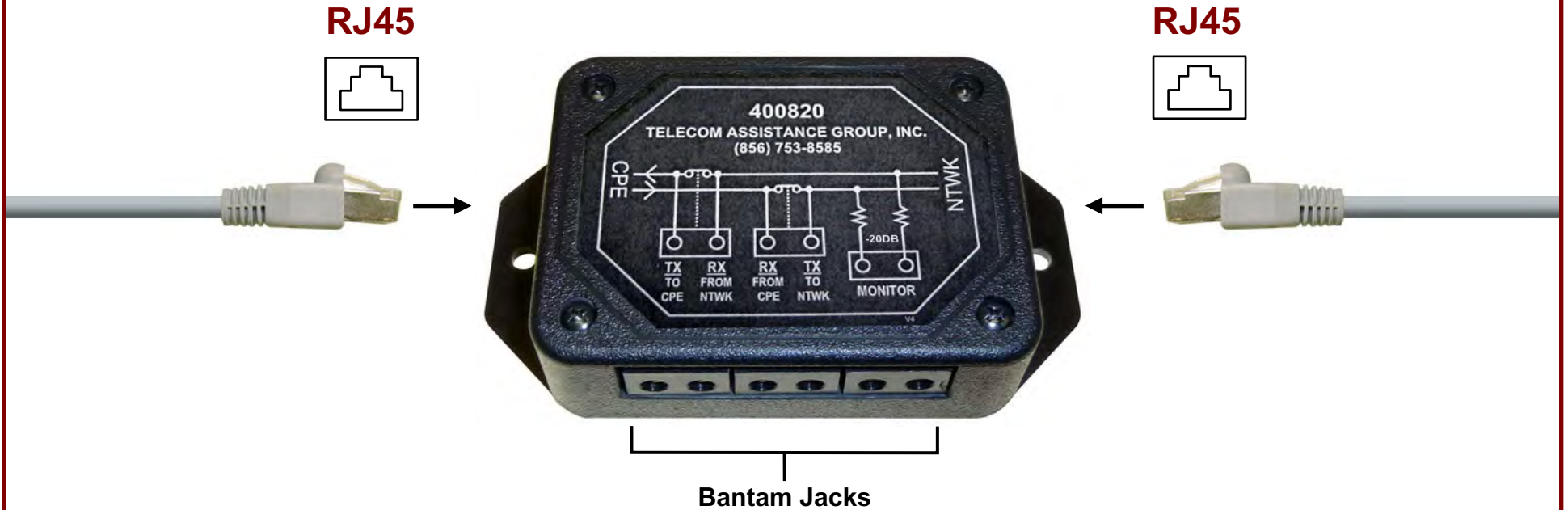

Application:

- Mounts between Network Interface Unit "Smart Jack" and Customer Service Unit (CSU)
- Monitors T1 signal, loopback or drop & insert

Ordering Information:

400820

T1 Monitor Box

AT&T PID #
ATT.100014561

150 Cooper Rd. (F-15)
W. Berlin, NJ 08091

www.tagcords.com
Telecom Assistance Group

Telephone: (856) 753-8585
Fax : (856) 768-7645

T1 Line Repeater Wiring Board

EXT-238

(EXT-238 - Plugs into T1, 56KB, HDSL, ISDN Apparatus Case)

Plug in T1 mini repeater slots for easy access to wiring via "Bantam jacks".

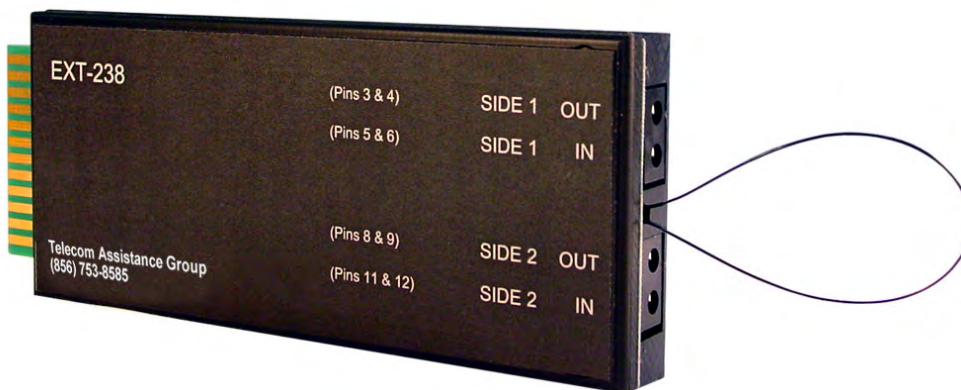

Features:

- Metallic access at mini T1 line repeater slots
- Verify wiring or access for "order wire"



400448LP

Temporary RJ-48 Looping Plug

Used to loop "Smart Jack" to provide physical loop

Ordering Information:

EXT-238 T1 Mini Repeater Access Board
400448LP Temporary RJ-48 Looping Plug
600209 Carrying Case

AT&T PID

ATT.100401640
ATT.100000561
ATT.100001655

400210A Bantam to (2) Alligator Clips, (6')

12 STATE **SOUTHEAST**
ATT.100038299 **ATT.100000681**

150 Cooper Rd. (F-15)
 W. Berlin, NJ 08091

www.tagcords.com

Telephone: (856) 753-8585
 Fax : (856) 768-7645

Telecom Assistance Group

T1 Repeater Test Kit

EXT-238K3

The EXT-238K3 Kit is designed for technicians who test at T1 Line Repeater Housings, such as 818 apparatus cases. (see Fig. 1) The Kit Includes:

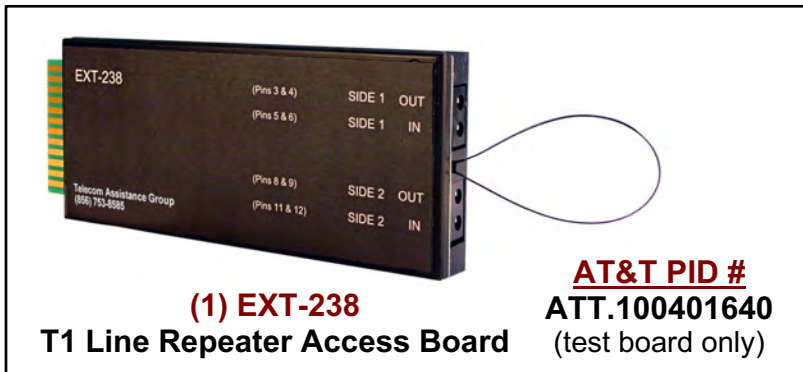
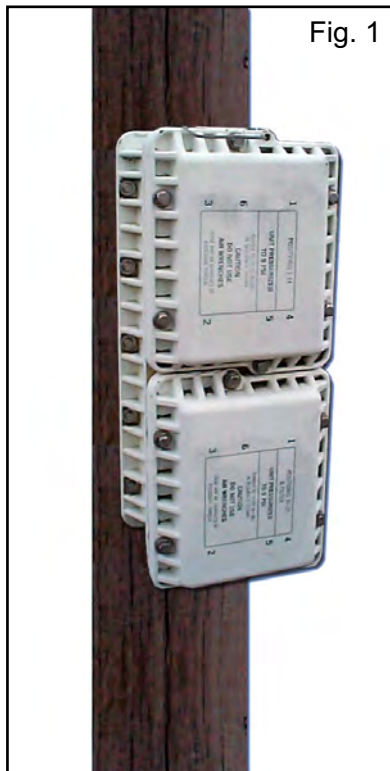

(1) 400210RD-03
Bantam to Bantam - Red, (3')



(1) 400210ARD-03
Bantam to Alligator Clips - Red, (3')



(1) 400210BK-03
Bantam to Bantam - Black, (3')



(1) 400210ABK-03
Bantam to Alligator Clips - Black, (3')

Ordering Information:

EXT-238K3

T1 Repeater Access Kit

includes: (1) EXT-238, (1) 400210RD-03,
(1) 400210BK-03, (1) 400210ARD-03,
(1) 400210ABK-03 & (1) 600209 - carrying case

AT&T PID # (KIT)
ATT.100001313

150 Cooper Rd. (F-15)
W. Berlin, NJ 08091

www.tagcords.com

Telephone: (856) 753-8585
Fax : (856) 768-7645

Telecom Assistance Group

Apparatus Cases (T1, HDSL, DDS)

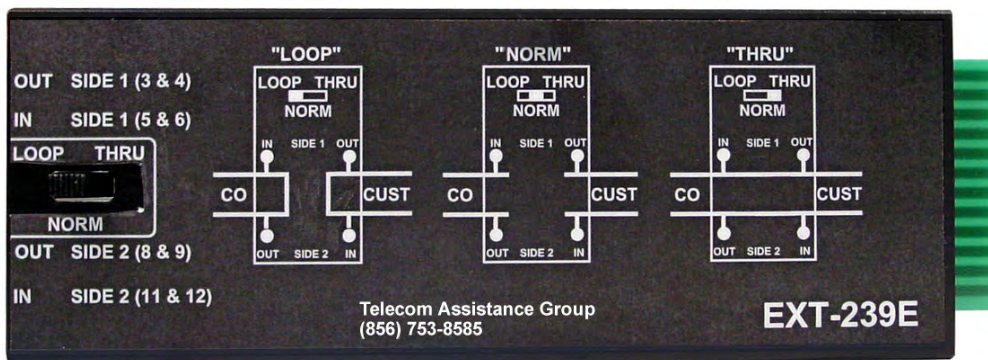

EXT-239E

Plugs into T1, 56KB, HDSL, ISDN Apparatus Cases

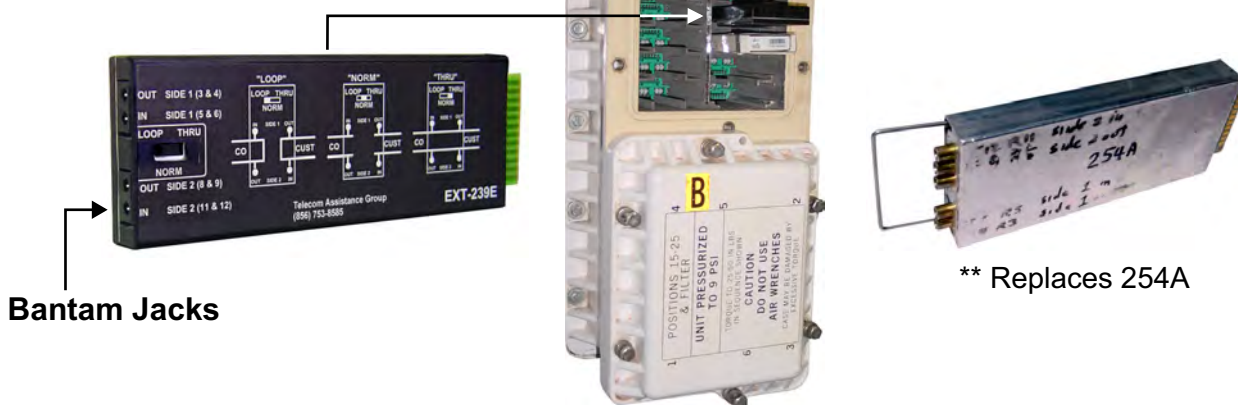

Features:

- Enhanced switch settings for Thru, Norm, and Loop testing at T1 line repeater apparatus cases
- Metallic access at T1 line repeater slots
- Use with test sets to perform Cable Loss, Resistance, or TDR test set to locate load coils

Ordering Information:

EXT-239E	T1 Wiring Access Board	AT&T PID # ATT.100001303
400210A	Bantam to Alligator Clips, (6')	12 STATE ATT.100038299
600100C	Test Board Carrying Case	SOUTHEAST ATT.10000681 ATT.100001273

150 Cooper Rd. (F-15)
W. Berlin, NJ 08091

www.tagcords.com

Telephone: (856) 753-8585
Fax : (856) 768-7645

Telecom Assistance Group

EXT-209B / EXT-209T

Ordering Information:

Part # EXT-209B

12 STATE SOUTHEAST
ATT.100070054 ATT.100001207

Description: T1 Loopback Extender

- Universal interface to all test sets
- Loops signal and simplex current
- Isolates trouble to repeater or cable
- Bantam Jack access eliminates special probes and cables
- Direct metallic bridging allows current, voltage and loop resistance measurements



Part # EXT-209T

12 STATE SOUTHEAST
ATT.100080891 ATT.100000481

Description: T1 Repeater Extender

- Span current test points
- Loops signal and simplex current
- Test repeaters in the field
- Bantam Jack access to monitor/transmit QRSS, 3 in 24 from test sets
- Direct metallic bridging allows current, voltage and loop resistance measurements



Part # 600100C

12 STATE SOUTHEAST
ATT.100038527 ATT.100001273

Description: Test Board Carrying Case



150 Cooper Rd. (F-15)
W. Berlin, NJ 08091

www.tagcords.com

Telephone: (856) 753-8585
Fax : (856) 768-7645

Telecom Assistance Group

Test Boards

"DDM Plus"



12 STATE **SOUTHEAST**
 ATT.100071977 ATT.100012819

TB-86B

"DDM Plus" Office Repeater Test Board w/ Bantam Jacks

Application:

The TB-86B provides metallic access via bantam jacks to test at office repeater card slots. Utilizing standard test sets and bantam test cords, the TB-86B becomes a powerful tool in testing in the Central Office, Remote Terminals and CEV's.

Note: Also available with Pin Jacks. The **TB-86** provides metallic access via Pin Jacks commonly used with volt/ohm meters. To order see below.

TB-231B

220 Office Repeater Test Board w/ Bantam Jacks

Application:

The TB-231B provides metallic access via bantam jacks to test at office repeater card slots. Utilizing standard test sets and bantam test cords, the TB-231B becomes a powerful tool in testing in the Central Office, Remote Terminals and CEV's.

Note: Also available with Pin Jacks. The **TB-231** provides metallic access via Pin Jacks commonly used with volt/ohm meters. To order see below.



"Kentrox"

12 STATE **SOUTHEAST**
 ATT.100071973 ATT.100001307

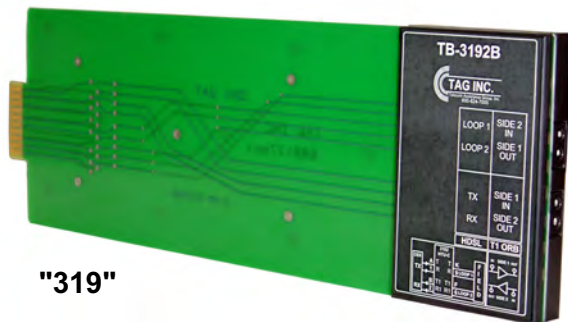

"319"

12 STATE **SOUTHEAST**
 ATT.100069270 ATT.100000553

TB-3192B

3190/3192 Office Repeater Test Board w/ Bantam Jacks

Application:

The TB-3192B provides metallic test access via bantam jacks in 3190 & 3192 office repeater card slots. Utilizing standard test sets and bantam test cords, the TB-3192B becomes a powerful tool in testing in the Central Office, Remote Terminals and CEV's.

Note: Also available with Pin Jacks. The **TB-3192** provides metallic access via Pin Jacks commonly used with volt/ohm meters. To order see below.

Ordering Information:

		12 STATE	SOUTHEAST
TB-86	"DDM Plus" Office Repeater Test Board * w/ Pin Jacks - *(not pictured)	ATT.100071976	ATT.100012821
TB-231	220 Office Repeater Test Board ** w/ Pin Jacks - **(not pictured)	ATT.100012823	ATT.100012823
TB-3192	3190/3192 Office Repeater Test Board *** w/ Pin Jacks - ***(not pictured)	ATT.100071974	ATT.100000555

150 Cooper Rd. (F-15)
 W. Berlin, NJ 08091

www.tagcords.com

Telephone: (856) 753-8585
 Fax : (856) 768-7645

Telecom Assistance Group

Adtran



TB-TA3000-ORB

Adtran Total Access 3000 Test Board (w/ Bantam Jacks)

Application:

The TB-TA3000-ORB plugs in the Adtran Total Access 3000 card slots and has bantam jacks that allow access to the cabling from the card slot toward the DSX-1 and the Field - HDSL. Using a T1 Test Set, the tester can transmit and receive T1 signals to verify cable acceptance and continuity.

12 STATE **SOUTHEAST**
ATT.100070282 **ATT.100001305**
 (test board only) (test board only)

400210RD
 Bantam to Bantam-Red, (6')

AT&T PID #
ATT.100068132



400210BK
 Bantam to Bantam-Black, (6')

AT&T PID #
ATT.100408970



400210A
 Bantam to Alligator Clips, (6')

12 STATE **SOUTHEAST**
ATT.100038299 **ATT.100000681**



Approx. Dimensions:
 9" (H) x 16" (L)



600209N
 Carrying Case
AT&T PID #
ATT.100001277

Ordering Information:

KIT-TA3000BST **Adtran TA3000 Test Kit**
 includes: (1) TB-TA3000-ORB,
 (1) 400210BK, (1) 400210RD,
 (1) 400210A & (1) 600209N

12 STATE (KIT)
ATT.100071968

SOUTHEAST (KIT)
ATT.100011883

150 Cooper Rd. (F-15)
 W. Berlin, NJ 08091

www.tagcords.com

Telephone: (856) 753-8585
 Fax : (856) 768-7645

Telecom Assistance Group

Alcatel 7330 RT DSLAM Streaker Kit

7330KIT-OSP

Project Lightspeed / U-verse / VRAD



(1) CT-7330
Alcatel 7330 Streaker Unit
12 STATE SOUTHEAST
 ATT.100070240 ATT.100011745
 (streaker unit only)



(1) 400409X
Grounding Cord,
Pin Plug to Large GND Clip, (6')



(1) P-2000
Continuity Test Probe w/ LED
12 STATE SOUTHEAST
 ATT.100070241 ATT.100011751



(1) 400188-50
Amphenol Test Cable, (50')
12 STATE SOUTHEAST
 ATT.100070243 ATT.100011683



(1) 600209NL
Carrying Case
12 STATE SOUTHEAST
 ATT.100070242 ATT.100011691



BX-50*
50 Pin Breakout Box
12 STATE: ATT.100070245
SOUTHEAST: ATT.100011757

**Sold Separately, Not Included with Kit*

Application:

The 7330 RT DSLAM Streaker Kit provides a quick method to verify continuity from the 7330 to SAI Wire Termination Points - checking all interconnect cabling and connectors. The Tester will ground the terminating points and verify that wiring is correct via LED's.

Ordering Information:

7330KIT-OSP Alcatel RT DSLAM Streaker Kit

includes: (1) CT-7330, (1) 400409X,
 (1) 400188-50, (1) 3004935-503 (manual),
 (1) P-2000 & (1) 600209NL - carrying case

12 STATE (KIT)
ATT.100070239

SOUTHEAST (KIT)
ATT.100011739

150 Cooper Rd. (F-15)
 W. Berlin, NJ 08091

www.tagcords.com

Telephone: (856) 753-8585
 Fax : (856) 768-7645

Telecom Assistance Group

Dat@Term* Block Test Probe - Single Blade

P-2000DTS

P-2000DTS

Dat@Term* Block Test Probe w/ Protection, Single Blade, (25')

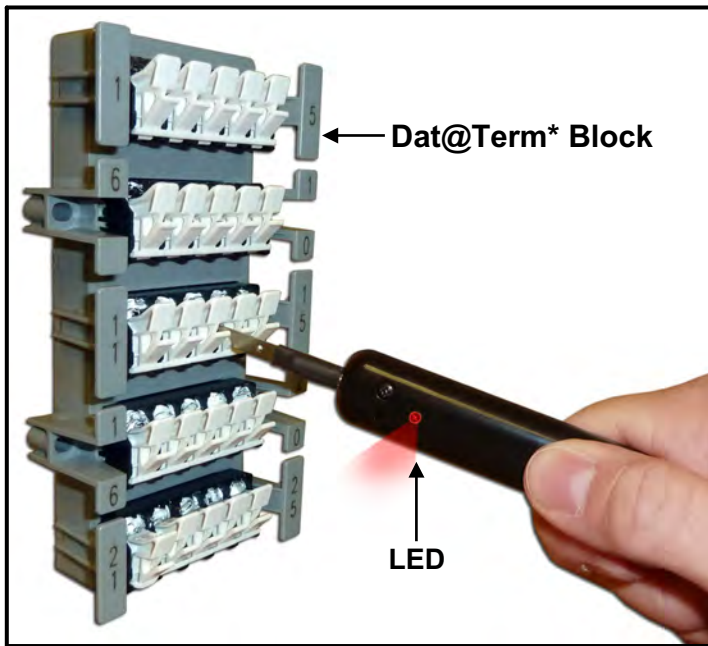

Touch Probe End to TIP / RING on Dat@Term* Block

LED

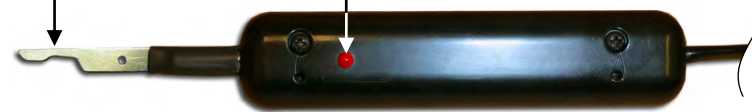

Application:

The P-2000DTS Dat@Term* Block Test Probe is used with TAG Inc. streaker cards by outside plant technicians streaking equipment that is wired to a Tyco Dat@Term* Block. The P-2000DTS allows ease of testing Tip/Ring wiring to the Dat@term* Block. The P-2000DTS is -48V protected and is also equipped with an LED for connectivity validation.

Ordering Information:

P-2000DTS

Dat@Term* Block Test Probe w/ Protection, Single Blade, (25')

AT&T PID #

ATT.100052703

150 Cooper Rd. (F-15)
W. Berlin, NJ 08091

www.tagcords.com

Telecom Assistance Group

Telephone: (856) 753-8585

Fax : (856) 768-7645

Litespan 2000 Test Kit

LS2000-KIT

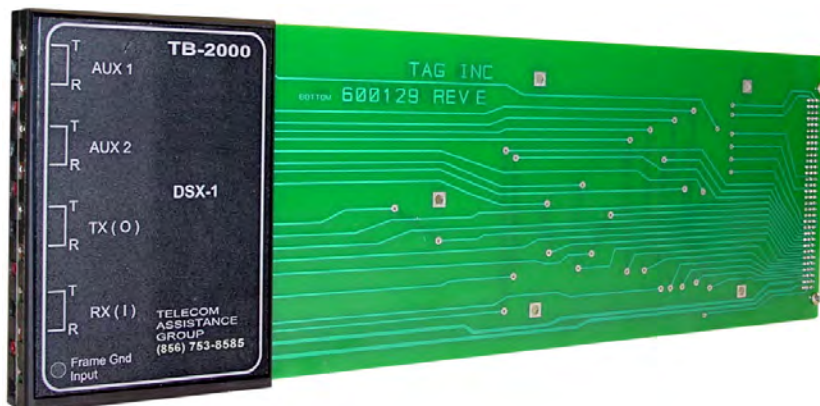

(1) TB-2000
Litespan 2000 Test Board
 (w/ Pin Jacks)

12 STATE
ATT.100080967
 (test board only)

SOUTHEAST
ATT.100011879
 (test board only)

Application:

The TB-2000 provides metallic access to backplane wiring in the Litespan 2000. Verify and test RPOTS cards slots wiring to the frame. Also test T1 slots (T1U & DSIU) wired to the DSX-1. Easy testing before Mux turn-up dates. With test equipment, a technician can quickly identify opens, shorts, crosses, and transmit and receive T1 signals between the MUX and DSX-1.

Accessories Included in Kit:



(1) 400210LP
 Bantam Looping Plug

AT&T PID #
ATT.100011805



(1) 600100C
 Carrying Case



(1) 400396-2A
 SLC -96 Line Adapter
 to Alligators, (1')

12 STATE
ATT.100041968

SOUTHEAST
ATT.100011807



12 STATE
ATT.100038527

SOUTHEAST
ATT.100001273

Ordering Information:

LS2000-KIT Litespan 2000 Test Kit
 includes: (1) TB-2000, (1) 400396-2A,
 (1) 400210LP & (1) 600100C

12 STATE (KIT)
ATT.100071971

SOUTHEAST (KIT)
ATT.100011881

Individual items can also be ordered

150 Cooper Rd. (F-15)
 W. Berlin, NJ 08091

www.tagcords.com

Telephone: (856) 753-8585
 Fax : (856) 768-7645

Telecom Assistance Group

Frame Tone / Temporary Jack Panel

F-TPJ-602

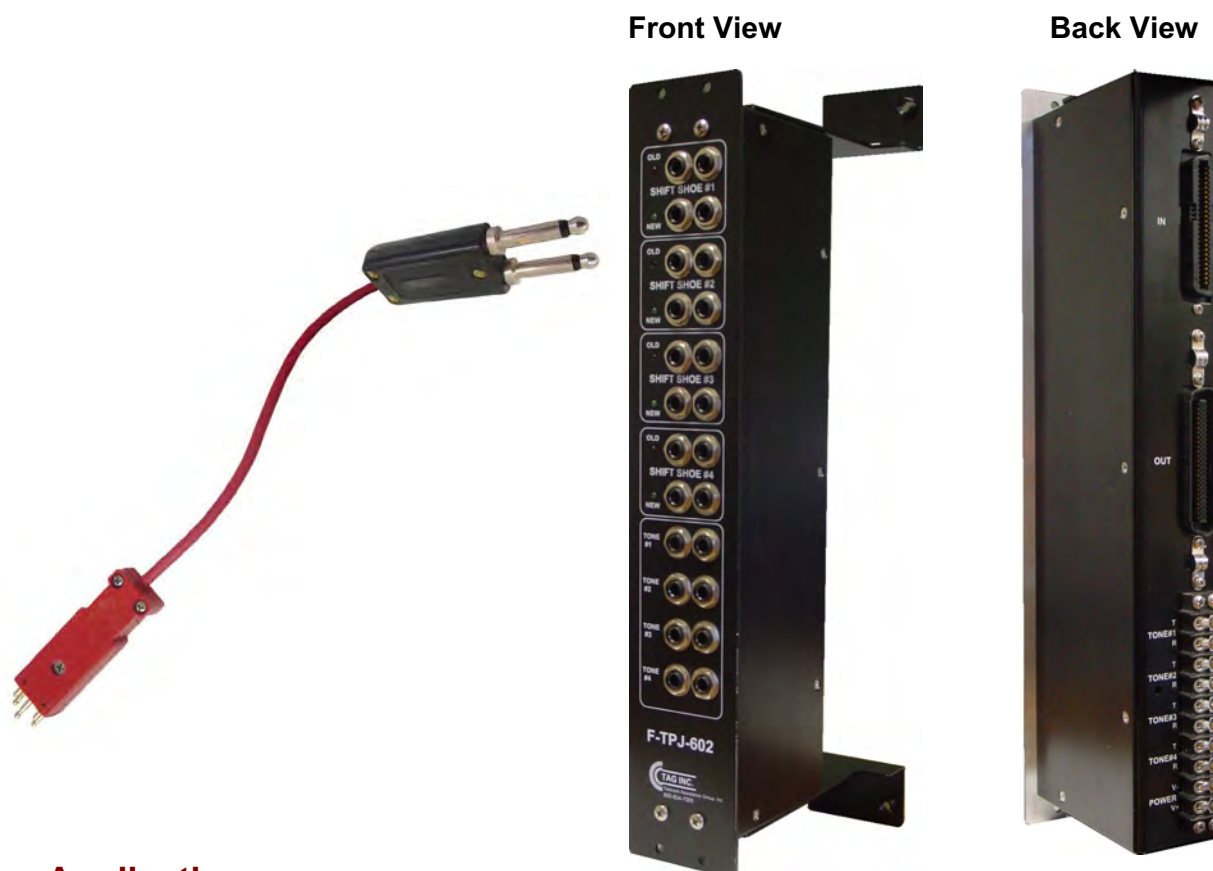

Application:

The F-TPJ-602 provides two (2) main functions:

1. Temporary restoral "old" to "new" at the MDF using existing frame cords.
2. Four (4) inputs to tone generators for easy jack access along the MDF.
Multiple points to send tones along the MDF without moving test sets.

The Frame Tone/Temporary Jack Panel is ideal for frames with multiple or various protector types. Easy mounting to MDF (vertical) and Cosmic frames.

Ordering Information:

		<u>AT&T PID #</u>
F-TPJ-602	Frame Tone / Restoral - Temporary Jack Panel	ATT.100409610
T-W4BR-P	Cord Test Shoe - Dual Plug (327) to Porta, (16')	ATT.100409620
T-4W6A-16	Cord Test Shoe - Dual Plug (327) to 252A/B, (16')	ATT.100409630
T-4W11A-16	Cord Test Shoe - Dual Plug (327) to 412A/B, (16')	ATT.100409640

TAG offers various MDF Products : "Frame Cords", Test Aids ("Hands Free Telephone"), Caller ID Test Devices and "Custom Products." CALL for a complete CATALOG.

150 Cooper Rd. (F-15)
W. Berlin, NJ 08091

www.tagcords.com

Telephone: (856) 753-8585
Fax : (856) 768-7645

Telecom Assistance Group

Test Jack Panel

TJ-327-02D



TJ-327-02D Test Jack Panel w/ (2) 327C Jacks

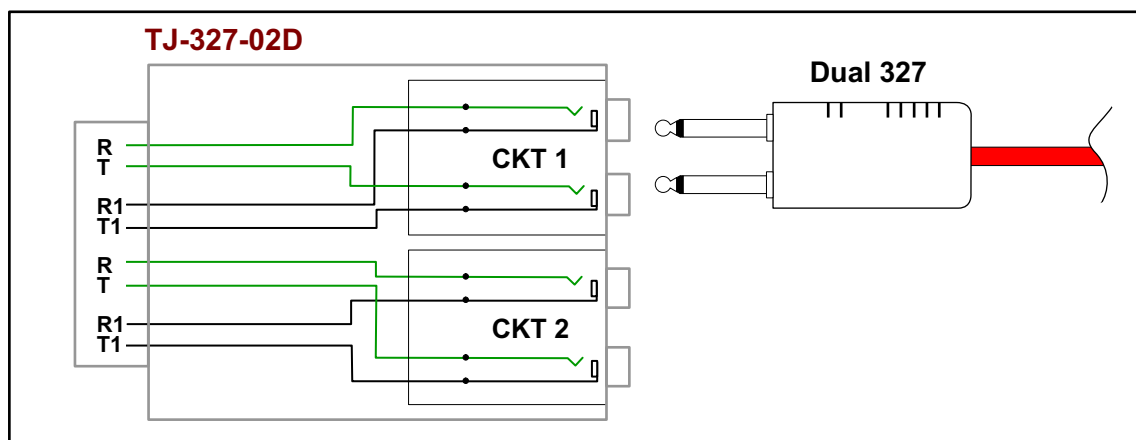
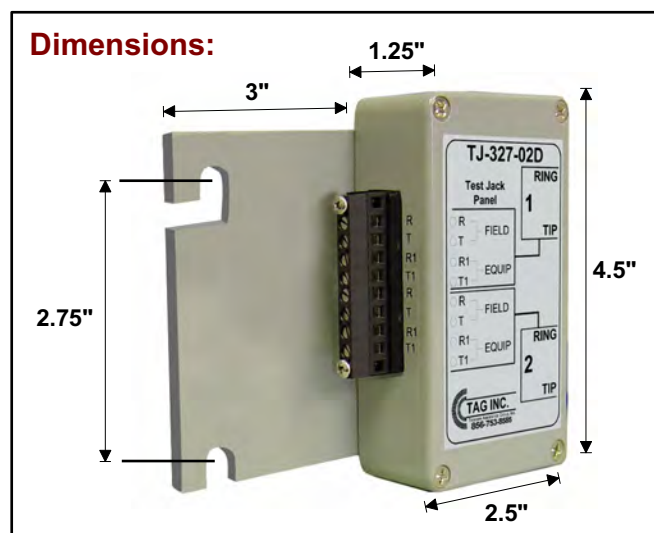

Application:

The TJ-327-02D Jack Panel provides access to (2) two independent Tip/Ring circuits using standard frame cords (Dual 327 to Protector). It conveniently mounts along the vertical side of the MDF. Connections are made to a terminal block at the rear of the unit.

Ordering Information:

TJ-327-02D

Test Jack Panel w/ (2) 327C Jacks

AT&T PID #

ATT.100035138

150 Cooper Rd. (F-15)
W. Berlin, NJ 08091

www.tagcords.com

Telephone: (856) 753-8585
Fax : (856) 768-7645

Telecom Assistance Group

D4 Monitor Cord, (5')

400480MHS

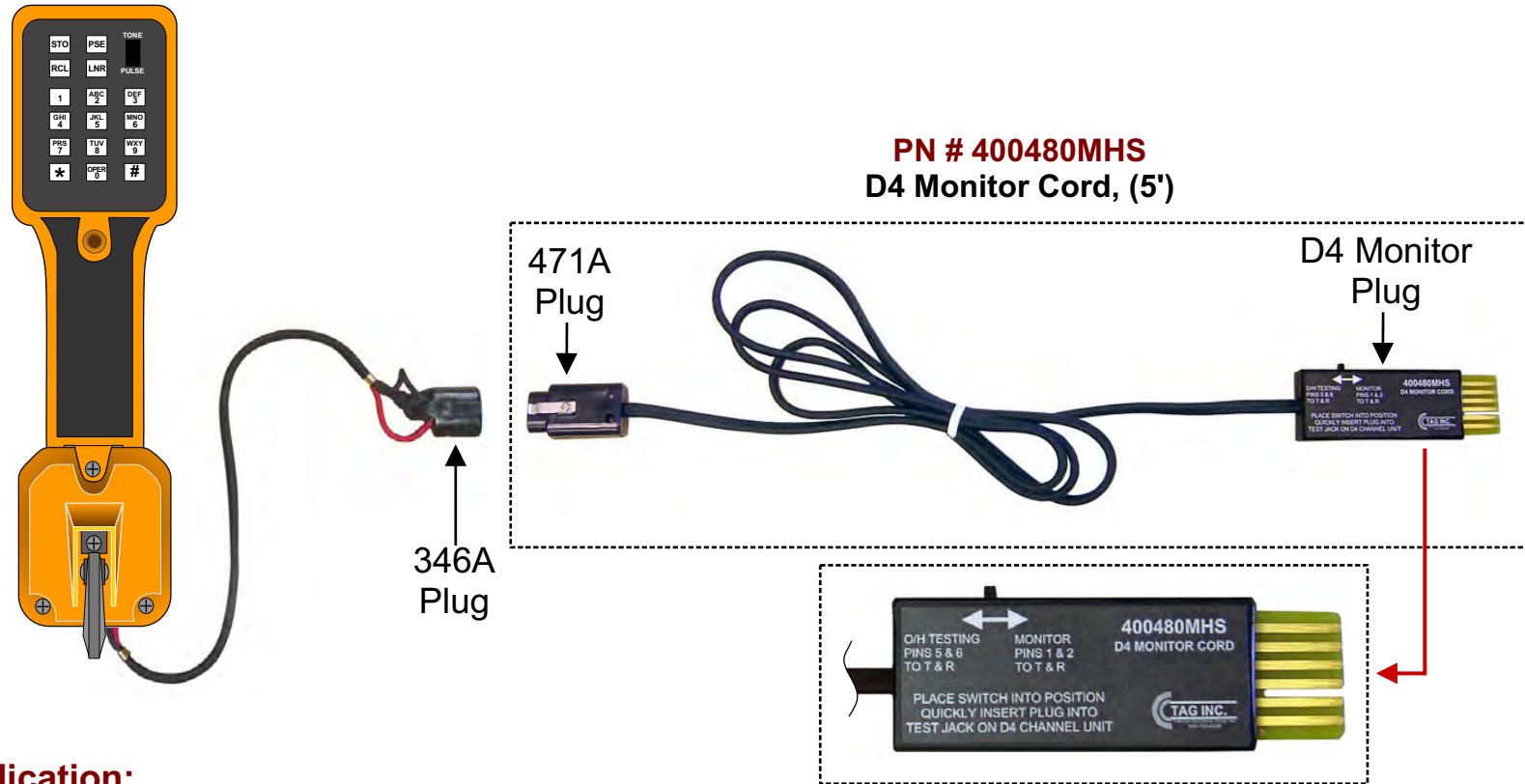

Application:

TAG's D4 Monitor Cord (PN# 400480MHS) is used to access dial tone from FXS and FXO cards. The D4 Monitor Cord directional switch enables dial tone to be pulled from the far end when plugged into the FXS card or near end (SMAS/Frame) when plugged into the FXO card.

Ordering Information:

400480MHS

D4 Monitor w/ Switch to 471A, (D4 Monitor Cord), (5')

AT&T PID #

ATT.100090489

150 Cooper Rd. (F-15)
W. Berlin, NJ 08091

www.tagcords.com

Telecom Assistance Group

Telephone: (856) 753-8585
Fax : (856) 768-7645

D4 Channel Break-Out Plugs w/ Test Points

"Right Angle"

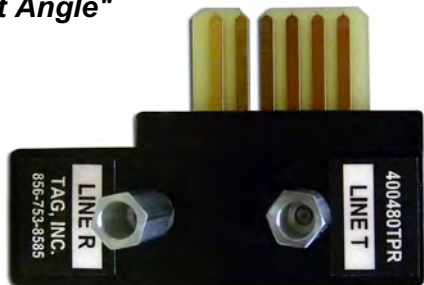

PN # 400480TPR
D4 Channel (R/A)
Break-Out Plug
w/ Test Points



"Straight"



PN # 400480TPS
D4 Channel (Straight)
Break-Out Plug
w/ Test Points



Wiring Details:

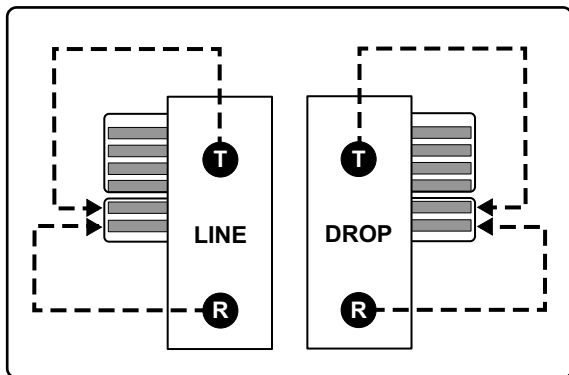

Wiring Details:

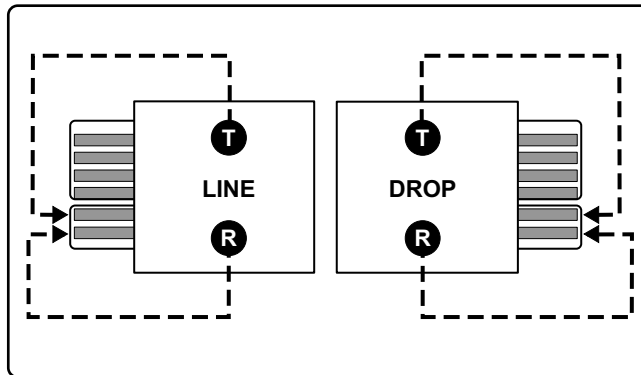

Ordering Information:

400480TPR

**D4 Channel (R/A) Break-Out Plug
w/ Test Points**

AT&T PID #

ATT.100090488

400480TPS

**D4 Channel (Straight) Break-Out Plug
w/ Test Points**

ATT.100090487

150 Cooper Rd. (F-15)
W. Berlin, NJ 08091

www.tagcords.com

Telephone: (856) 753-8585
Fax : (856) 768-7645

Telecom Assistance Group

D4 Channel Check Unit

T-D4CC

Need a CMC 5151 Channel Chek Unit ?

TAG has a Replacement Model for this previously discontinued part....

**DISCONTINUED
CMC 5151
CHANNEL CHEK UNIT
(YELLOW BOX)**



PN # T-D4CC
D4 Channel Check Unit



Application:

- With the switch in the idle "MONITOR" position, insert the # T-D4CC channel checker into the port on the face of the D4 card.
- Slide the switch to "DROP" & observe the led's for a green-red-green sequence indicating a "wink" from the local PBX equipment.

Ordering Information:

T-D4CC

D4 Channel Check Unit

**AT&T PID #
ATT.100090490**

150 Cooper Rd. (F-15)
W. Berlin, NJ 08091

www.tagcords.com

Telephone: (856) 753-8585
Fax : (856) 768-7645

Telecom Assistance Group

DB9 Pin (male) to DB9 Pin (female), (6')

400720

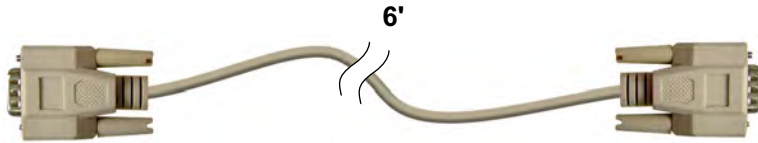

6'

PN # 400720

DB9 Pin (male) to DB9 Pin (female), (6')

12 STATE
ATT.100041957

SOUTHEAST
ATT.100000571

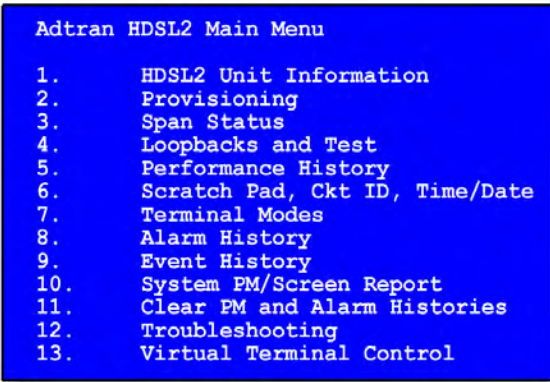

9 Pin connector on HDSL ckt



- Commonly used from Laptop to test at Pair Gain (HDSL)
- Wired straight

Ordering Information:

400720 DB9 Pin (male) to DB9 Pin (female), (6')

400720USB* DB9 Pin (male) / RS232 to USB Adapter Cable

Supports Windows® 2000 / XP / Server 2008 / Vista / 7 / 8 / 10

** (for laptops that don't have a serial port)*

12 STATE **SOUTHEAST**
ATT.100041957 ATT.100000571

AT&T PID #
ATT.100000993

150 Cooper Rd. (F-15)
W. Berlin, NJ 08091

www.tagcords.com

Telecom Assistance Group

Telephone: (856) 753-8585
Fax : (856) 768-7645

ORB Test Kit

KIT-TBORB-B



TB-86B

"DDM Plus" Office Repeater
Test Board w/ Bantam Jacks

12 STATE **SOUTHEAST**
ATT.100071977 ATT.100012819



TB-3192B

3190/3192 Office Repeater
Test Board w/ Bantam Jacks

12 STATE **SOUTHEAST**
ATT.100069270 ATT.100000553



TB-231B

220 (Kentrox size) Office Repeater
Test Board w/ Bantam Jacks

12 STATE **SOUTHEAST**
ATT.100071973 ATT.100001307



TB-400B

HDSL Remote HRU-200/400
Mechanics w/ Bantam Jacks

12 STATE **SOUTHEAST**
ATT.100071975 ATT.100001301



EXT-239E

T1 Line Repeater Access Board
w/ Bantam Jacks

AT&T PID #
ATT.100001303

400210A

(1) Bantam to Alligator Clips-Red, (6')

12 STATE **SOUTHEAST**
ATT.100038299 ATT.100000681



400210A

(1) Bantam to Alligator Clips-Black, (6')

12 STATE **SOUTHEAST**
ATT.100038299 ATT.100000681



600209N
Carrying Case

AT&T PID #
ATT.100001277

Ordering Information:

KIT-TBORB-B ORB Test Kit

includes: (1) TB-86B, (1) TB-231B, (1) TB-3192B, (1) TB-400B,
(1) EXT-239E, (2) 400210A & (1) 600209N

AT&T PID # (KIT)
ATT.100001199

150 Cooper Rd. (F-15)
W. Berlin, NJ 08091

www.tagcords.com

Telephone: (856) 753-8585
Fax : (856) 768-7645

Telecom Assistance Group

ORB Test Kit

KIT-TBORB-B02



TB-86B

"DDM Plus" Office Repeater
Test Board w/ Bantam Jacks

12 STATE **SOUTHEAST**
ATT.100071977 ATT.100012819



TB-3192B

3190/3192 Office Repeater
Test Board w/ Bantam Jacks

12 STATE **SOUTHEAST**
ATT.100069270 ATT.100000553



TB-231B

220 (Kentrox size) Office Repeater
Test Board w/ Bantam Jacks

12 STATE **SOUTHEAST**
ATT.100071973 ATT.100001307



TB-TA3000-ORB

Adtran Total Access 3000 Test Board
w/ Bantam Jacks

12 STATE **SOUTHEAST**
ATT.100070282 ATT.100001305



TB-400B

HDSL Remote HRU-200/400
Mechanics w/ Bantam Jacks

12 STATE **SOUTHEAST**
ATT.100071975 ATT.100001301



EXT-239E

T1 Line Repeater Access Board
w/ Bantam Jacks

AT&T PID #
ATT.100001303

400210A
(1) Bantam to Alligator Clips-Red, (6')

12 STATE **SOUTHEAST**
ATT.100038299 ATT.100000681



400210A
(1) Bantam to Alligator Clips-Black, (6')

12 STATE **SOUTHEAST**
ATT.100038299 ATT.100000681



600209N
Carrying Case

AT&T PID #
ATT.100001277

Ordering Information:

KIT-TBORB-B02 ORB Test Kit

includes: (1) TB-86B, (1) TB-231B, (1) TB-3192B,
(1) TB-400B, (1) TB-TA3000-ORB,
(1) EXT-239E, (2) 400210A & (1) 600209N

12 STATE (KIT)
ATT.100071970

SOUTHEAST (KIT)
ATT.100011891

150 Cooper Rd. (F-15)
W. Berlin, NJ 08091

www.tagcords.com

Telephone: (856) 753-8585
Fax : (856) 768-7645

Telecom Assistance Group

Portable "R" - HDSL Test Unit Kit

RHDSL-BST01

RHDSL-BST01
Portable "R" -
HDSL Test Unit Kit

12 STATE (KIT) ATT.100071972	SOUTHEAST (KIT) ATT.100011889
--	---



(1) 600509
Carrying Case



(cards not included)



4W-6P-08

- ▶ **4 Slots for 200/400 Mech. HDSL "R" Cards**
- ▶ **Rugged Connectors**
- ▶ **Various Test Cords**

(1) 4W-6P-08
Female Lock Plug to
(4) 6P Alligator Clips, (8')

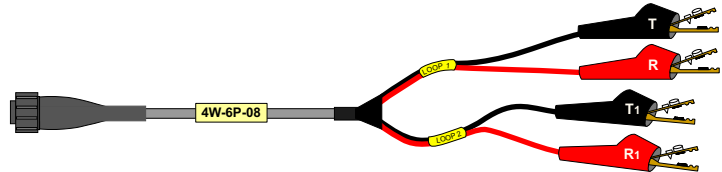

(1) 4W-463Y-08
Female Lock Plug to
5 Pin "Y" Protector, (8')

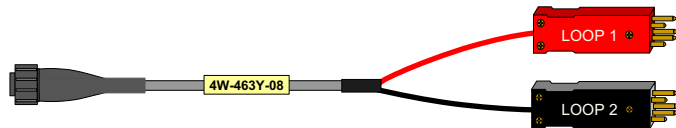

Ordering Information:

		12 STATE (KIT) ATT.100071972	SOUTHEAST (KIT) ATT.100011889
RHDSL-BST01	Portable "R" - HDSL Test Unit Kit includes: (1) T-RHDSL, (1) 4W-6P-08, (1) 4W-463Y-08 & (1) 600509		
T-RHDSL	Portable "R" HDSL Test Unit <i>(requires test cords)</i>	ATT.100071981	ATT.100011557
4W-463Y-08	Lock Plug (F) to 5 Pin "Y" Protector, (8')	ATT.100039928	ATT.100011859
4W-6P-08	Lock Plug (F) to (4) 6P Alligator Clips, (8')	AT&T PID #	
600509	Carrying Case	ATT.100022122 ATT.100001661	

**** Cords are Required for Testing ****

150 Cooper Rd. (F-15)
W. Berlin, NJ 08091

www.tagcords.com

Telephone: (856) 753-8585
Fax : (856) 768-7645

Telecom Assistance Group

Portable "C" - HDSL Powering Test Unit Kit

PHTUC-KIT01

The Kit Includes: (1) # **PHTUC-01**
 Portable "C" -
 HDSL Powering Test Unit
 w/ AC Power Cord

PN # PHTUC-KIT01
 Portable "C" -
 HDSL Powering Test Unit Kit



1 Slot (2 & 4 Wire)
 (3192 Mech. Card not included)

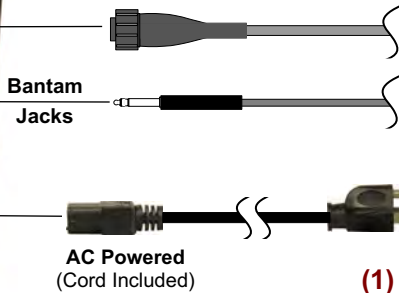

(1) # **600510**
 Carrying Case
AT&T PID # ATT.200002321
 (carrying case only)

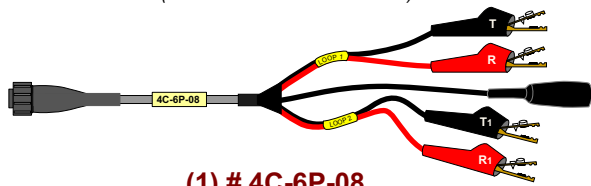

(1) # **4C-6P-08**
 Male Lock Plug to (4) 6P Alligator Clips w/ GND, (8')
AT&T PID # ATT.200002327 (cord only)

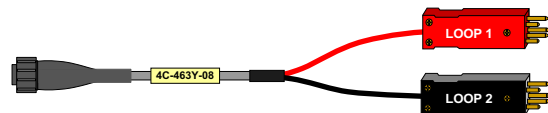

(1) # **4C-463Y-08**
 Male Lock Plug to 5 Pin "Y" Protector, (8')
AT&T PID # ATT.200002325 (cord only)



(1) # **400210BK**
 Bantam to Bantam Test Cord - Black, (6')



(1) # **400210RD**
 Bantam to Bantam Test Cord - Red, (6')

HDSL APPLICATION DIAGRAM

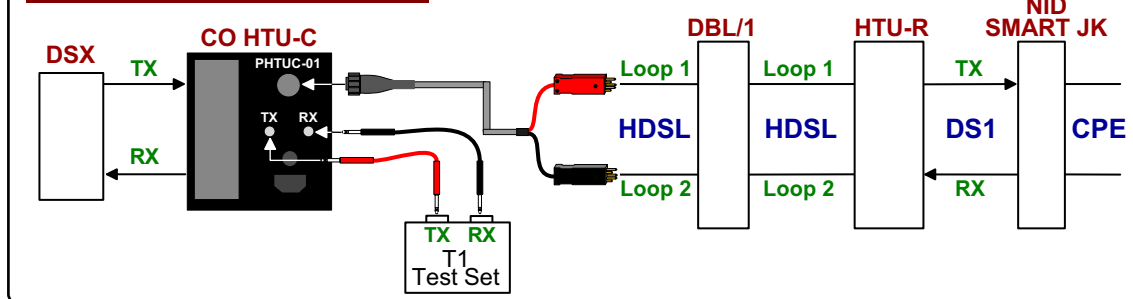

Ordering Information:

PHTUC-KIT01 Portable "C" - HDSL Powering Test Unit Kit
 includes: (1) PHTUC-01, (1) 4C-6P-08, (1) 4C-463Y-08,
 (1) 400210RD, (1) 400210BK & (1) 600510

AT&T PID # (KIT)
ATT.200002322

150 Cooper Rd. (F-15)
 W. Berlin, NJ 08091

www.tagcords.com

Telephone: (856) 753-8585
 Fax : (856) 768-7645

Telecom Assistance Group

20' - 4C Frame Cords for Central Office Portable "C" - HDSL Powering Test Unit

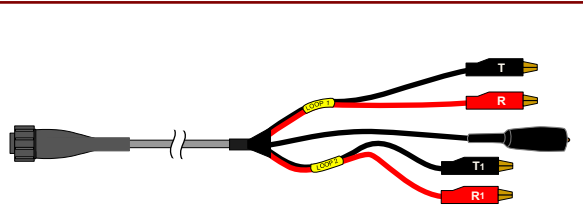

4C-A-20
Male Lock Plug to
(4) Std Alligator Clips w/ GND, (20')

AT&T PID # ATT.200002328

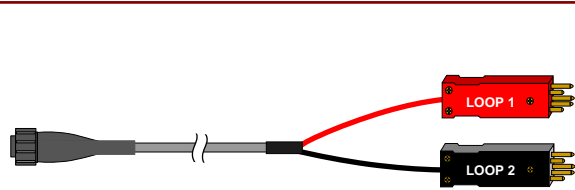

4C-463Y-20
Male Lock Plug to
Protector "Y", (20')

AT&T PID # ATT.200002330

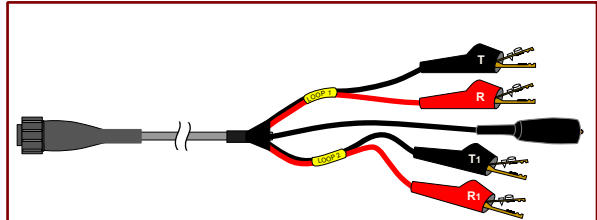

4C-6P-20
Male Lock Plug to
(4) 6P Alligator Clips w/ GND, (20')

AT&T PID # ATT.200002329

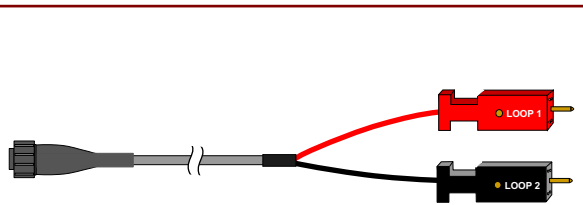

4C-PORTY-20
Male Lock Plug to
Porta "Y", (20')

AT&T PID # ATT.200002331

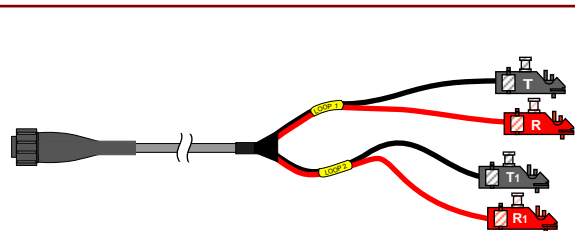

4C-252Y-20
Male Lock Plug to
252 "Y" Plugs, (20')

AT&T PID # ATT.200002332

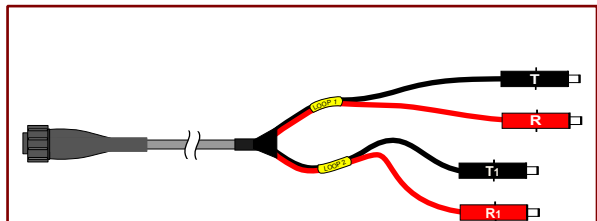

4C-412Y-20
Male Lock Plug to
412 "Y" Plugs, (20')

AT&T PID # ATT.200002333

- All Cords are available in other lengths -

150 Cooper Rd. (F-15)
W. Berlin, NJ 08091

www.tagcords.com
Telecom Assistance Group

Telephone: (856) 753-8585
Fax : (856) 768-7645

AT&T Recommended Test Kit for Subscriber Acceptance Testing

KIT-RHPCR, AT&T PID # ATT.100035181

REF: ATT-TELCO-620-000-230

(1) # PHTUC-01
Portable "C" - HDSL Powering Test Unit



(card not included)

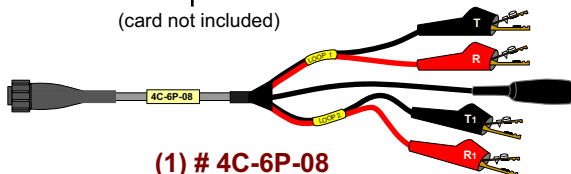

(1) # 4C-6P-08
Male Lock Plug to (4) 6P Alligator Clips w/ GND, (8')

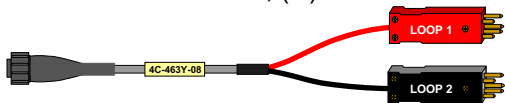

(1) # 4C-463Y-08
Male Lock Plug to 5 Pin "Y" Protector, (8')

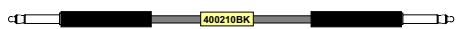

(1) # 400210BK
Bantam to Bantam Test Set Cord - Black, (6')

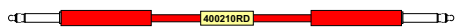

(1) # 400210RD
Bantam to Bantam Test Set Cord - Red, (6')

(1) # T-RHDSL
Portable "R" - HDSL Test Unit

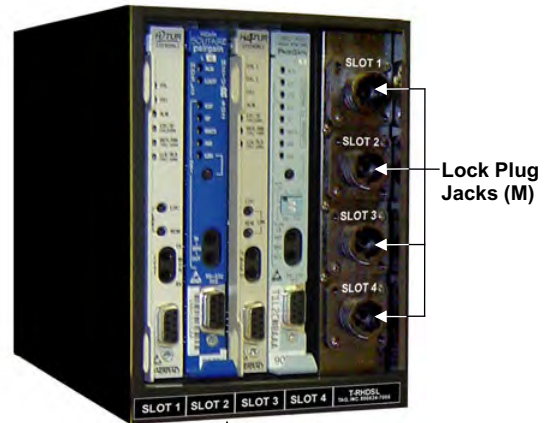

(cards not included)

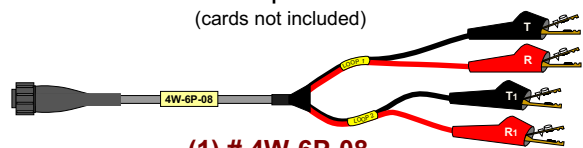

(1) # 4W-6P-08
Female Lock Plug to (4) 6P Alligator Clips, (8')

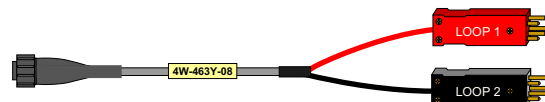

(1) # 4W-463Y-08
Female Lock Plug to 5 Pin "Y" Protector, (8')



Ordering Information:

KIT-RHPCR **Portable "C" HDSL Powering Unit & Portable "R" Unit Kit**
includes: (1) PHTUC-01, (1) T-RHDSL, (1) 4C-6P-08,
(1) 4C-463Y-08, (1) 400210RD, (1) 400210BK,
(1) 4W-6P-08, (1) 4W-463Y-08 & (2) Carrying Cases

AT&T PID # (KIT)
ATT.100035181

150 Cooper Rd. (F-15)
W. Berlin, NJ 08091

www.tagcords.com

Telephone: (856) 753-8585
Fax : (856) 768-7645

Telecom Assistance Group

20' - 4W Frame Cords for Central Office Portable "R" - HDSL Test Unit

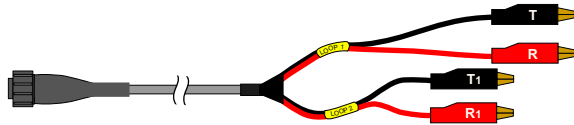

4W-A-20
Female Lock Plug to
(4) Std Alligator Clips, (20')

AT&T PID # ATT.100090481

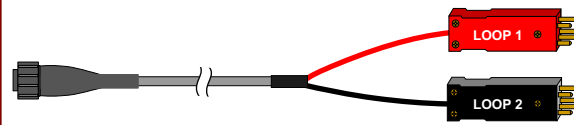

4W-463Y-20
Female Lock Plug to
Protector "Y", (20')

AT&T PID # ATT.100090482

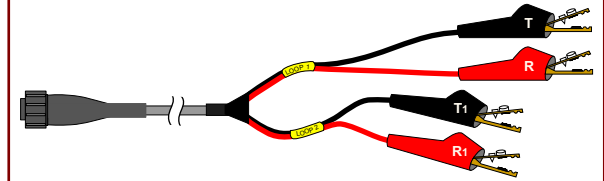

4W-6P-20
Female Lock Plug to
(4) 6P Alligator Clips, (20')

AT&T PID # ATT.100090483

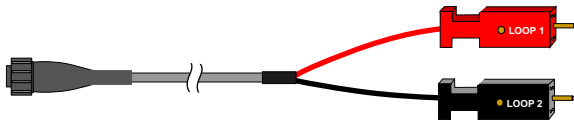

4W-PORTY-20
Female Lock Plug to
Porta "Y", (20')

AT&T PID # ATT.100090484

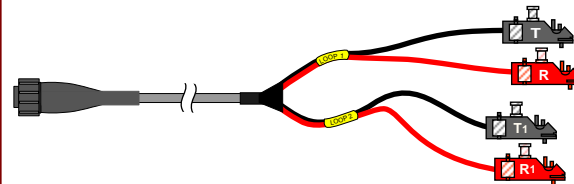

4W-252Y-20
Female Lock Plug to
252 "Y" Plugs, (20')

AT&T PID # ATT.100090485

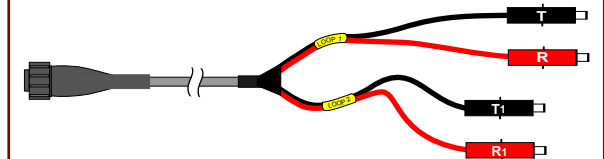

4W-412Y-20
Female Lock Plug to
412 "Y" Plugs, (20')

AT&T PID # ATT.100090486

- All Cords are available in other lengths -

150 Cooper Rd. (F-15)
W. Berlin, NJ 08091

www.tagcords.com
Telecom Assistance Group

Telephone: (856) 753-8585
Fax : (856) 768-7645

CO Portable HDSL "Hot Shoe" Kit

The CO Portable HDSL "Hot Shoe" Kit is Designed for Central Offices

- ▶ 4 Slots for 200/400 Mech. HDSL "R" Cards
- ▶ Rugged Connectors



(cards not included)



4W-A-20 →



A VARIETY OF 20' CORDS ARE AVAILABLE!!
 (see the previous page for 463A cord & others)

Leave the Portable HDSL Unit on the floor & **SAFELY CLIMB CO LADDERS**

Ordering Information:

RHDSL-HDCO-01 CO Portable HDSL "Hot Shoe" Kit
 includes: (1) T-RHDSL, (1) 4W-A-20 & (1) 600509 - carrying case

AT&T PID # (KIT)
ATT.100090480

150 Cooper Rd. (F-15)
 W. Berlin, NJ 08091

www.tagcords.com
Telecom Assistance Group

Telephone: (856) 753-8585
 Fax : (856) 768-7645

AT&T Approved - NEBS Certified - Ericsson AXE-10 IOG11 Drive Solutions from TAG

**ERICSSON AXE-10 IOG11 MODULES
w/ EXISTING HARD DRIVE & OPTICAL DISK DRIVE
(w/ "MOVING PARTS")**



**AXE-10 IOG11 MODULES
w/ NEW SOLID STATE DRIVES FROM TAG**

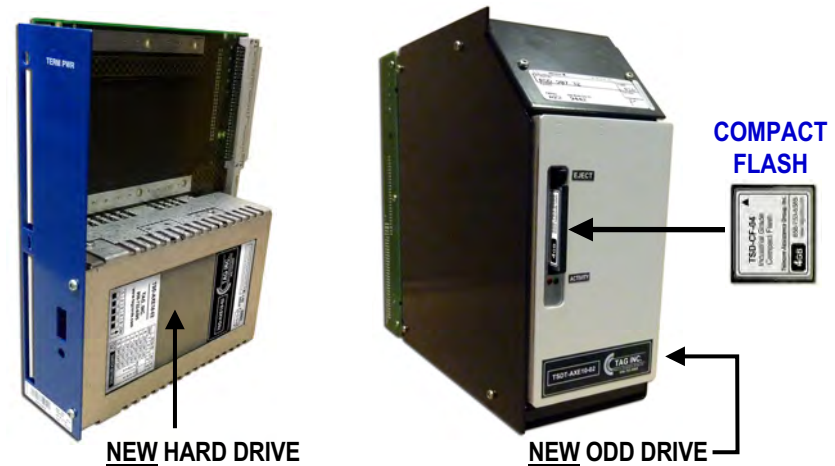

Application:

TAG can **REPLACE** failing / broken Hard Drives and Optical Disk Drives within Ericsson AXE-10 IOG11 Modules with **NEW** Solid State Drives.

NEW SOLID STATE DRIVES AVAILABLE FROM TAG

TAG MODEL #	USE IN EXISTING AXE-10 IOG11 HARD DRIVE MODULE (HECI DNPQAL9AAA)	
TSD-AXE10-02	Solid State Replacement for: Ericsson AXE-10 IOG11 Module # ROF 137 7942/8 R1A HD-B 2GB (HECI DNPQAL9AAA) Hard Drive	2 Gb
	AT&T PID # ATT.DNPQAL9AAA	
TAG MODEL #	USE IN EXISTING AXE-10 IOG11 ODD MODULE (HECI DNMYABKEAA)	
TSDT-AXE10-02	Solid State Replacement for: Ericsson AXE-10 IOG11 Module # ROD 907 32 (HECI DNMYABKEAA) Optical Disk Drive <i>Includes: 4Gb Industrial Compact Flash Card (PN # TSD-CF-AXE, AT&T PID # ATT.200009339)</i>	4 Gb
	AT&T PID # ATT.DNMYABKEAA	

150 Cooper Rd. (F-15)
W. Berlin, NJ 08091

www.tagcords.com
Telecom Assistance Group

Telephone: (856) 753-8585
Fax : (856) 768-7645

AT&T Approved - NEBS Certified - DPP Disk Drive Solutions from TAG

**NORTEL DMS-100 SWITCH
w/ EXISTING DPP DRIVES (w/ "MOVING PARTS")**

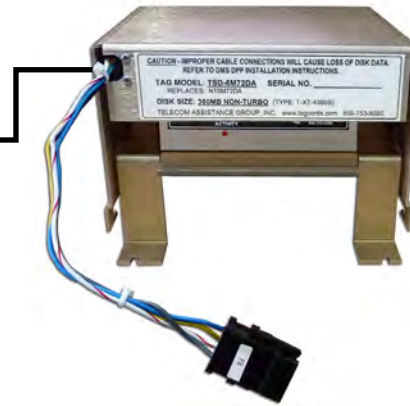
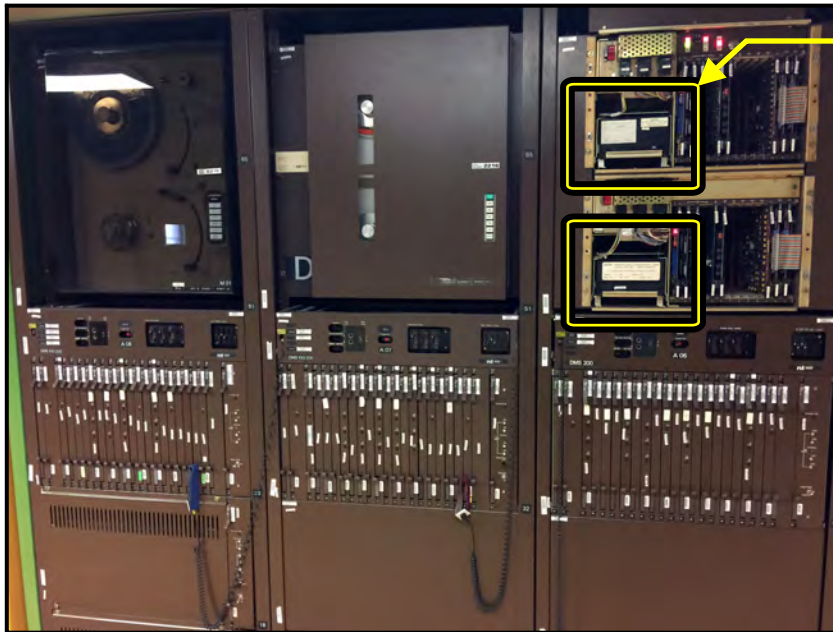

**NEW REPLACEMENT
SOLID STATE
SCSI DRIVE MODULE
FROM TAG**



(BACK VIEW)

NEW DPP AMA DISK DRIVES AVAILABLE FROM TAG

TAG MODEL #	Replaces PN / HECI			AT&T PID #
TSD-6M72BA	NT6M72BA / ENPQBB61XX	140 mb	non turbo	CALL
TSD-6M72DA	NT6M72DA	380 mb	non turbo	CALL
TSD-6M72DD	NT6M72DD	380 mb	turbo	ATT.100107964
TSD-6M72EA	NT6M72EA / ENPQ72EAAA	760 mb	turbo	ATT.ENPQ72EAAA
TSD-6M72GA	NT6M72GA / AMPQADFJAA NT6M72JA / AMPQAECJAA	1 gb	turbo	ATT.AMPQADFJAA
TSD-6M72HA	NT6M72HA / AMPQADGJAA NT6M72KA / AMPQAEBJAA	2 gb	turbo	ATT.AMPQADGJAA

Application:

TAG can **REPLACE** failing / broken Nortel DMS-100/10 switch Distributed Processing Peripheral (DPP) and Billing Media Converter (BMC) Disk Drives. These systems allow for remote polling of Automatic Message Accounting (AMA) data from the Nortel DMS-100/10 switch to central billing collector sites.

150 Cooper Rd. (F-15)
W. Berlin, NJ 08091

www.tagcords.com
Telecom Assistance Group

Telephone: (856) 753-8585
Fax : (856) 768-7645

AT&T Approved (Tape Drive) - NEBS Certified - Stromberg Carlson DCO Drive Solutions from TAG

**DCO MSDA 822010 CIRCUIT PACKS
w/ EXISTING HARD DRIVE & TAPE DRIVE (w/ "MOVING PARTS")**

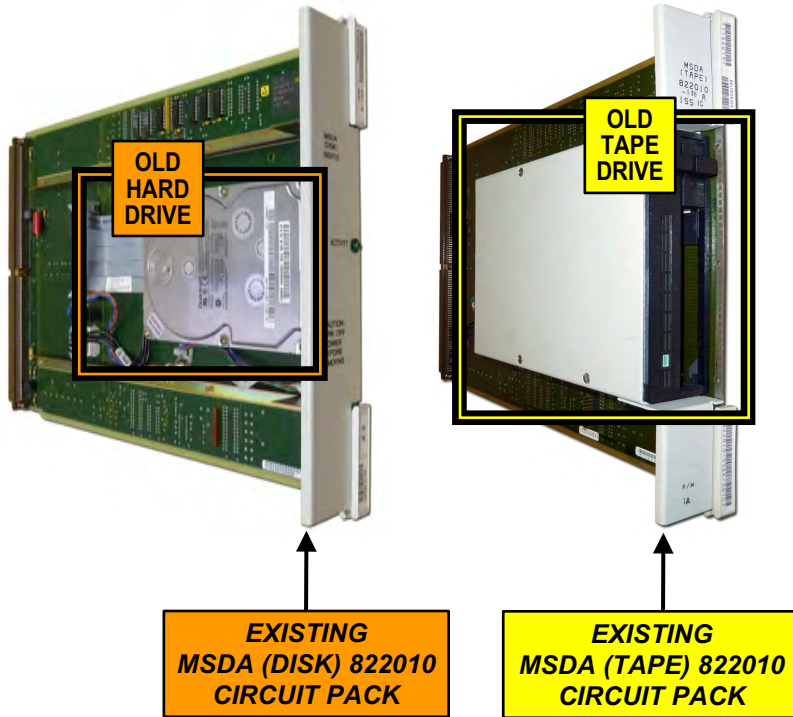

**NEW SOLID STATE DRIVES FROM TAG
(INSTALLED ON EXISTING CIRCUIT PACKS)**

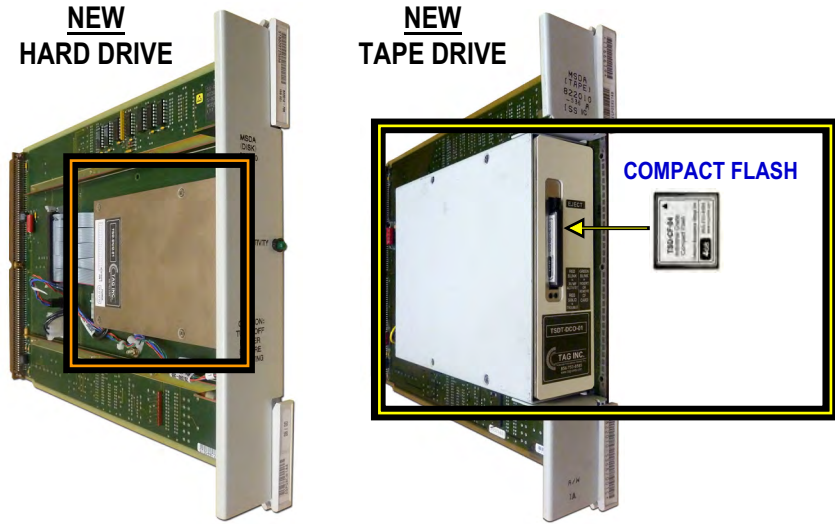

TAG MODEL #	USED ON EXISTING MSDA (DISK) 822010 CIRCUIT PACK
TSD-DCO-01 (CALL)	Solid State Replacement Hard Drive used on: Stromberg Carlson DCO, MSDA (DISK) 822010-706, 4.5Gb
TSD-DCO-02 (CALL)	Solid State Replacement Hard Drive used on: Stromberg Carlson DCO, MSDA (DISK) 822010-716, 9Gb
TAG MODEL #	USED ON EXISTING MSDA (TAPE) 822010 CIRCUIT PACK
TSDT-DCO-01RW	Solid State Replacement Tape Drive KIT used on: Stromberg Carlson DCO, MSDA (TAPE) 822010-536, 822010-616, 822010-646, 822010-656 <i>Kit Includes: QTY of (1) # TSDT-DCO-01 (DCO Tape Drive) & QTY of (4) # TSD-CF-04 (4Gb Industrial Compact Flash Card)</i>
AT&T PID # ATT.100113475	
<i>Additional Compact Flash Cards are Available (QTY of (1)): 4Gb (# TSD-CF-04, AT&T PID # ATT.200002174), 16Gb (# TSD-CF-16, AT&T PID # ATT.200002177), 32Gb (# TSD-CF-32, AT&T PID # ATT.200002176)</i>	

Application:

TAG can **REPLACE** older or failing Hard (Disk) Drives & Tape Drives on existing Stromberg Carlson DCO, MSDA 822010 circuit packs with **NEW** Solid State Drives.

150 Cooper Rd. (F-15)
W. Berlin, NJ 08091

www.tagcords.com

Telecom Assistance Group

Telephone: (856) 753-8585
Fax: (856) 768-7645

New Replacement Dumb Terminals - Transport / DACS Equipment

**NEW TERMINAL WORKS ON
Titan 5500, CS1, CS1L, DACS II, III, IV, Alcatel 1631 & HDSL**
(Titan 5500 shown below)

**REMOVE & REPLACE
OLD / BROKEN CRTs**



**AT&T PID #
ATT.100087610**

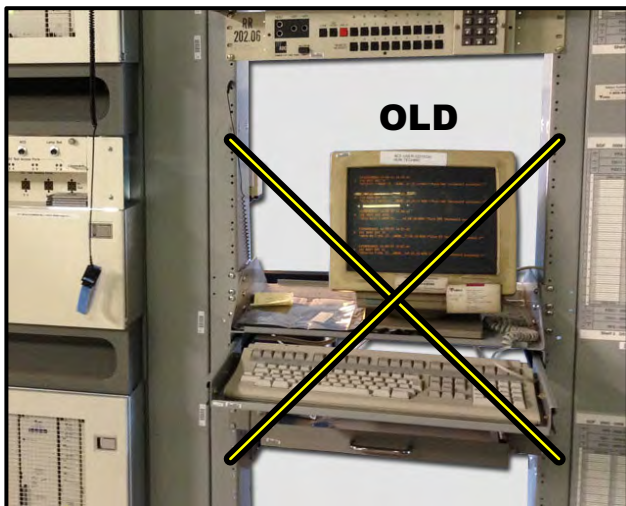

SPECIFICATIONS

- VT-100 COMPATIBLE
- SINGLE RS-232 INPUT
- PRINTER OUTPUT
- LOW POWER

New Terminal Includes:

- (1) 17" Flat Screen Monitor
- (1) Dumb Terminal Controller
- (1) Keyboard
- (1) Quick Guide
- (1) 400701, (DB25M Gender Changer)

Ordering Information:

TT-VT100S TAG Replacement Dumb Terminal - Transport / DACS
includes: (1) 17" Flat Screen Monitor, (1) Keyboard, (1) DB25M Gender Changer,
(1) Single Session Dumb Terminal Controller & (1) Quick Guide

**AT&T PID #
ATT.100087610**

TT-DCA5-PP Replacement Power Pack for VT Terminals, 5VDC **ATT.200009334**

400705-XX* **DB25M to DB25M - Serial Cable, (XX')** (optional - call for pricing)
* Please specify length of cable when ordering - Ex: 400706-25 = 25'

150 Cooper Rd. (F-15)
W. Berlin, NJ 08091

www.tagcords.com

Telephone: (856) 753-8585
Fax : (856) 768-7645

Telecom Assistance Group

5ESS MCC / ROP Terminal

**TAG offers a New Feature on our 5ESS MCC Dumb Terminal,
The "Glass Printer" Feature**

REMOVE & REPLACE OLD / BROKEN CRTs & PRINTERS

OLD



NEW

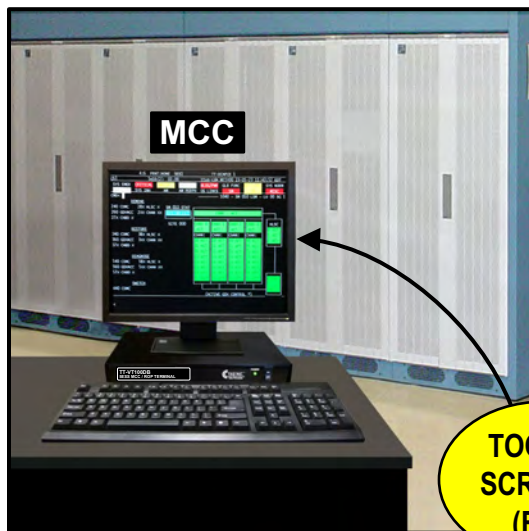

**TOGGLE
SCREENS
(F12)**



**ROP
PRINTER**

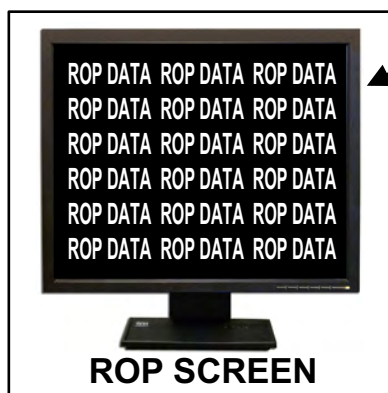

ROP SCREEN

*new label on
the keyboard
above the
F12 key*



SPECIFICATIONS

- VT-100 COMPATIBLE
- LOW POWER
- AUTO-BAUD

Ordering Information:

TT-VT100DB	5ESS MCC / ROP Terminal includes: (1) 17" Flat Screen Monitor, (1) Keyboard, (1) MCC Terminal Controller w/ ROP Glass Printer & Auto Baud Feature, (2) # 400701, DB25M Gender Changers & (1) Quick Guide	AT&T PID # ATT.200006843
TT-DCA5-PP	Replacement Power Pack for Terminals, 5VDC	ATT.200009334

150 Cooper Rd. (F-15)
W. Berlin, NJ 08091

www.tagcords.com

Telephone: (856) 753-8585
Fax : (856) 768-7645

Telecom Assistance Group

DMS Terminal Replacements - Dual Session

Model:

TT-DCAP-DMSKIT

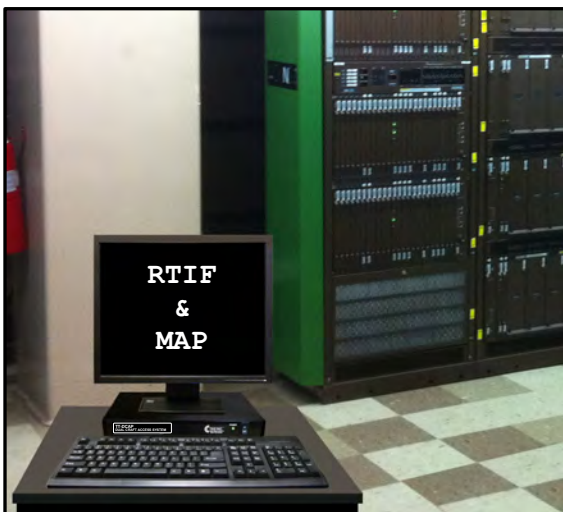

Kit Includes (TT-DCAP-DMSKIT):

- (1) 17" Flat Screen Monitor
- (1) Dumb Terminal Controller
- (1) Keyboard
- (1) Quick Guide
- (2) 400700, (DB25F Gender Changer) 
- (2) 400725SB2, (DMS Quick Connect Current Loop Adapter Cable w/ DEC Connector)



SPECIFICATIONS

- VT-100 COMPATIBLE
- DUAL RS-232 INPUTS
- PRINTER OUTPUT
- LOW POWER

Printer Port Type:



Parallel * * If a Serial Port is needed, please order a Parallel to Serial Adapter # TT-PSA, Call for Pricing.

Ordering Information:

TT-DCAP-DMSKIT	Dual Craft Access System - DMS Kit includes: (1) 17" Flat Screen Monitor, (1) Keyboard, (1) Dual Session Dumb Terminal Controller, (1) Quick Guide, (2) # 400700 (DB25F Gender Changer) & (2) # 400725SB2 (DMS Quick Connect Current Loop Adapter Cable w/ DEC Connector)	AT&T PID # ATT.200007660
TT-DCAP-DMSKIT1	Dual Craft Access System - DMS (Kit 1) includes: (1) 17" Flat Screen Monitor, (1) Keyboard, (1) Dual Session Dumb Terminal Controller, (1) Quick Guide, (2) # 400700 (DB25F Gender Changer) & (1) # 400725SB2 (DMS Quick Connect Current Loop Adapter Cable w/ DEC Connector)	AT&T PID # ATT.200007657
TT-DCAP-DMSKIT2	Dual Craft Access System - DMS (Kit 2) includes: (1) 17" Flat Screen Monitor, (1) Keyboard, (1) Dual Session Dumb Terminal Controller, (1) Quick Guide, (2) # 400700 (DB25F Gender Changer), (2) # 400725SB2 (DMS Quick Connect Current Loop Adapter Cable w/ DEC Connector) & (2) # 400725SBW** (Hardwire Adapter for 400725SB2) **not shown	AT&T PID # ATT.200007655
TT-DCAP	Dual Craft Access System - DMS includes: (1) 17" Flat Screen Monitor, (1) Keyboard, (1) Dual Session Dumb Terminal Controller, (1) Quick Guide & (2) # 400700 (DB25F Gender Changer)	AT&T PID # ATT.200007659
TT-DCA5-PP	Replacement Power Pack for Terminals, 5VDC	ATT.200009334

150 Cooper Rd. (F-15)
W. Berlin, NJ 08091

www.tagcords.com

Telephone: (856) 753-8585
Fax : (856) 768-7645

Telecom Assistance Group

DMS/100/10 Current Loop Adapter & Accessories

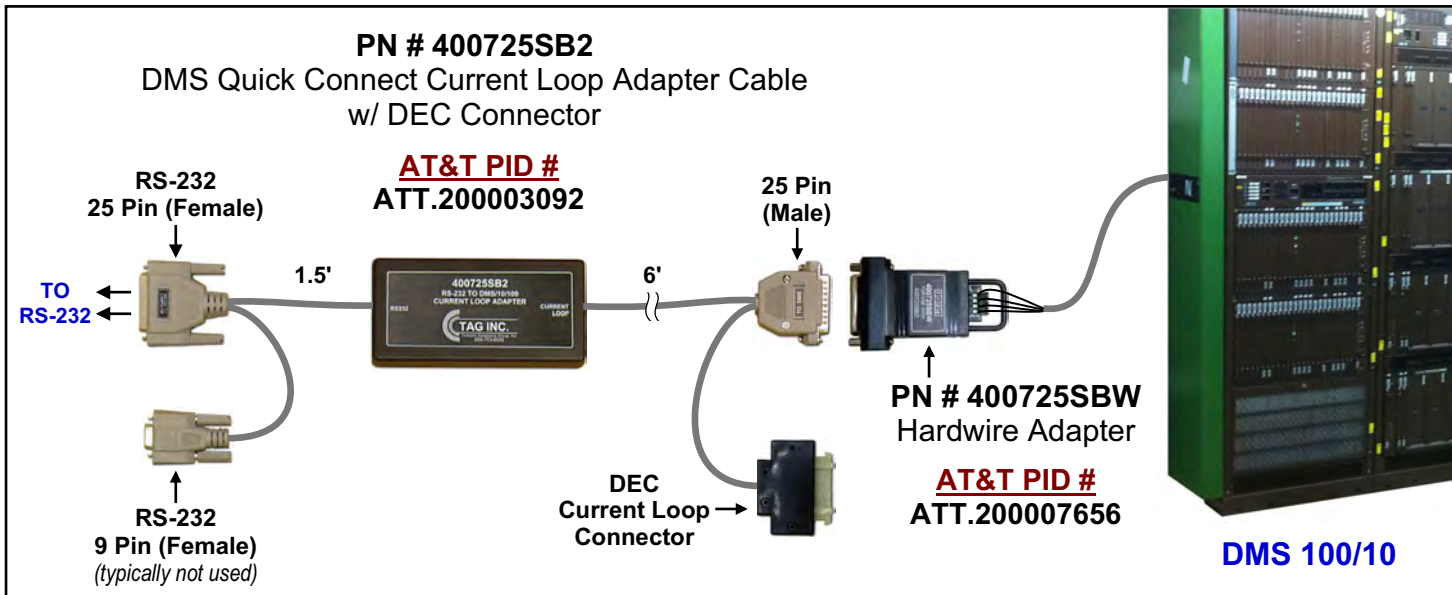

Also Available -

PN # 400725LB
DB25M to DB25F
Mini Tracer

AT&T PID #
ATT.200007658

Application:

TAG's Current Loop Adapter Cable (# 400725SB2) is used to program and troubleshoot a DMS. The Hardwire Adapter (# 400725SBW) connects the TX (+/-) and RX (+/-) current loop wires to a 25 Pin female connector. It is used with the 400725SB2 Current Loop Adapter when the DMS 100/10 System doesn't have a DEC connector.

Ordering Information:

		<u>AT&T PID #</u>
400725SB2	DMS Quick Connect Current Loop Adapter Cable w/ DEC Connector	ATT.200003092
400725SBW	Hardwire Adapter for 400725SB2	ATT.200007656
400725LB	DB25M to DB25F Mini Tracer	ATT.200007658
TT-DCA5-PP	Replacement Power Pack for Single/Dual Session Terminals, 5VDC (not shown)	ATT.200009334

150 Cooper Rd. (F-15)
W. Berlin, NJ 08091

www.tagcords.com
Telecom Assistance Group

Telephone: (856) 753-8585
Fax: (856) 768-7645

DMS-10/100 Pre-Charge Tool

T-DMSTBT

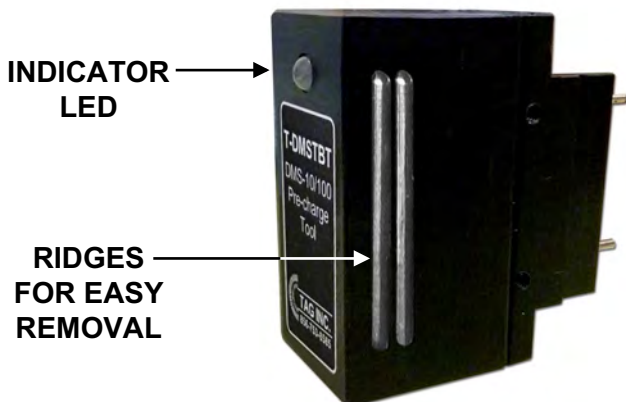

PN # T-DMSTBT
DMS-10/100
 Pre-Charge Tool

(replacement for NTA0600512)

AT&T PID #
ATT.200008588

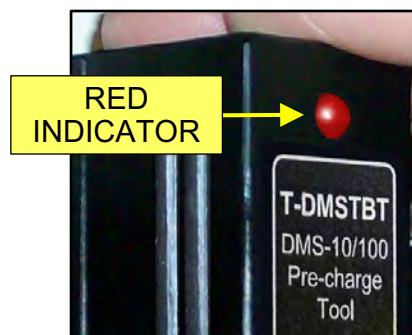

- THE INDICATOR GOES OUT WHEN IT IS SAFE TO INSTALL THE FUSE (APPROX. 10 SEC).
- IF THE INDICATOR STAYS LIT, THERE IS A LOAD OR FAULT ON THE CIRCUIT.

Application:

TAG's PN # T-DMSTBT is used to pre-charge shelf power capacitors on a DMS-10/100 switch. This allows a new fuse to be installed without seeing full in-rush surge current. The indicator light goes out when it is safe to install the fuse.

Ordering Information:

T-DMSTBT

DMS-10/100 Pre-Charge Tool
(replacement for NTA0600512)

AT&T PID #
ATT.200008588

150 Cooper Rd. (F-15)
 W. Berlin, NJ 08091

www.tagcords.com

Telephone: (856) 753-8585
 Fax : (856) 768-7645

Telecom Assistance Group

5ESS "Pre-Charge" Tool

T-5ESSPCT

5ESS Fuse Bay Control Panel,
Lucent # ED-83024-30

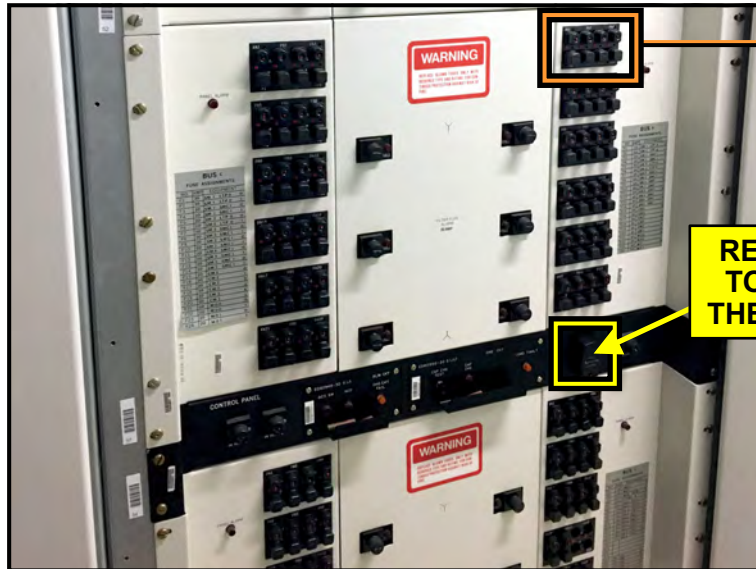

REPLACES BROKEN
TOOL LOCATED ON
THE CONTROL PANEL

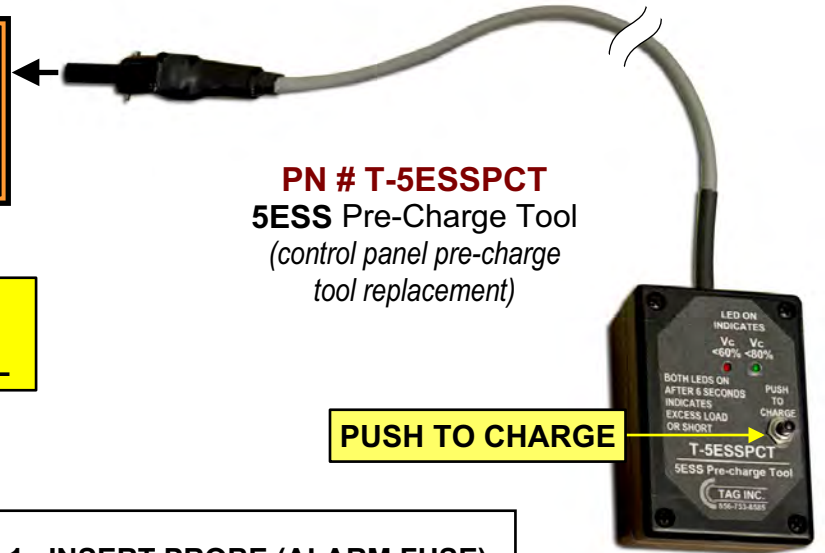

PN # T-5ESSPCT
5ESS Pre-Charge Tool
(control panel pre-charge
tool replacement)

PUSH TO CHARGE

1. INSERT PROBE (ALARM FUSE)
2. PRESS TEST BUTTON
3. RED & GRN LEDS WILL LIGHT
4. 4-6 SEC LEDS WILL GO OUT
5. INSTALL MAIN FUSE
6. IF RED LED STAYS ON EXCESS LOAD OR SHORT IS PRESENT

Application:

TAG's PN # T-5ESSPCT is used to pre-charge shelf power capacitors of a 5ESS switch. This allows a new fuse to be installed without seeing full in-rush surge current. The indicator light goes out when it is safe to install the fuse.

Ordering Information:		AT&T PID #
T-5ESSPCT	5ESS "Pre-Charge" Tool for Capacitor Charging at Main Fuse Bay (control panel pre-charge tool replacement)	ATT.200011751

150 Cooper Rd. (F-15)
W. Berlin, NJ 08091

www.tagcords.com
Telecom Assistance Group

Telephone: (856) 753-8585
Fax : (856) 768-7645

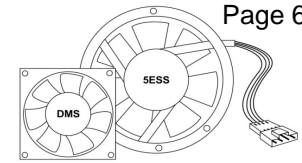

Part #	Description		
5ESS FANS			
TF-5ESS-01P	KS22501L3 Equiv.	5ESS Fan w/ 3 Leads & AMP Connector (fan w/ power prongs)	HECI E5PQAM9
TF-5ESS-01F	KS22501L3 Equiv.	5ESS Fan w/ 3 Leads & Fastons (fan w/ power prongs)	HECI E5PQAM3
TF-5ESS-02P	KS23912L1A Equiv.	5ESS Fan w/ 5 Leads & AMP Connector w/ Internal Thermal Speed Control Sensor	HECI E5PQANE HECI E5PQANC
TF-5ESS-02F	KS23912L1A Equiv.	5ESS Fan w/ 5 Leads & Fastons w/ Internal Thermal Speed Control Sensor	HECI E5PQAM8 HECI E5PQAM6
TF-5ESS-03P	KS23912L2 Equiv.	5ESS Fan w/ 4 Leads & AMP Connector	HECI SPPQABJ
TF-5ESS-04P	KS22501L3A Equiv.	5ESS Fan w/ 5 Leads & AMP Connector	HECI E5PQAND
TF-5ESS-04F	KS22501L3A Equiv.	5ESS Fan w/ 5 Leads & Fastons	HECI E5PQAM7
TF-5ESS-05P	KS23912L1 Equiv.	5ESS Fan w/ 3 Leads & AMP Connector (w/ power prongs)	HECI E5PQANA
TF-5ESS-05F	KS23912L1 Equiv.	5ESS Fan w/ 3 Leads & Fastons (w/ power prongs)	HECI E5PQAM5
TF-5ESS-10P	KS23398L2 Equiv.	5ESS ISLU (Square) w/ 5 Leads & AMP Connector	HECI E5PQANG
ALCATEL FANS			
TF-ALC-01	Alcatel 1000 / 7300, 48V Fan w/ 3 Wire Plug & Tach (3EC 15478, 37933 & 36760)		ATT.200003125
TF-AL7300-02	Alcatel 7300, 48V Fan w/ 3 Wire Plug, Sensor & Tach (use in 3EC 16697 (XXXX))		ATT.200003124
TF-DSCECS1-01	DSC / Alcatel ECS1, 48V Fan w/ 3 Wire Plug		ATT.200000452
TF-ALC1603-01	Alcatel 1603, 48V Fan w/ 3 Wire Plug (use in Low-Volume Fan Tray # 625052-000-0XX)		
TF-ALC1631-01	Alcatel 1631, 48V Fan w/ Power Prongs (use in Assembly # 695-3363-302)		ATT.200006515
TF-ALC1631-02	Alcatel 1631, 48V Fan w/ Pwr Prongs & Unterminated Tach (use in # 3AL45446AA)		ATT.200004402
TF-ALC1631-03	Alcatel 1631 APS, 48V Fan w/ Pwr Prongs & Untermin Tach (use in # 695-8489-001)		ATT.200009343
TF-ALC1680-01	Alcatel 1680 OGX, 48V Fan (Round) w/ Power Prongs & Tach Lead (use in #3EM04820AA)		
CIENA / CISCO 15454 / CALIX E7 / KENTROX FANS			
TF-CN1600-01	Ciena 1600 DWDM, 48V Fan (fan only, mounting not included)		ATT.200003616
TF-DN7100-01	Ciena DN7100, 12V Fan w/ 3 Wire Plug		
TF-DN7100-02	Ciena DN7100, 12V Fan w/ 3 Wire Plug		ATT.200008568
TF-C15454-01	Cisco ONS 15454, 48V Fan w/ 3 Wire Right Angle Connector		ATT.200005896
TF-CLXE7-01	Calix E7-2 FTA2 Fan Unit, 12V (40mm x 20mm) Fan for w/ 4 Wire Plug		
TF-AI-180	Kentrox AISwitch Series 180, 48V Cooling Fan		
DATAKIT / GALAXY RECTIFIER / FUJITSU FANS			
TF-DATAKIT-01	24V Fan for Datakit System w/ 3 Wire, 4 Pin Connector		ATT.200006911
TF-GLX595LTB-01	48V Fan for Galaxy 595LTB Rectifier w/ 4 Wire Plug		
TF-FLM150-01	48V (80mm) Fan for Fujitsu FLM 150 Fan Tray w/ 3 Wire Plug		
TF-FW4500-01	48V Fan for Flashwave 4500 Fan Unit w/ 4 Wire Plug (use in # FC9580FAN1, HECI: SNPQCUG5AB)		
LORAIN / MARCONI RECTIFIER FANS			
TFT-MRECT	New Fan Tray Assembly for Vortex Rectifier (Lorain/Marconi 104545) (V200D50)		ATT.200003632
TF-MREC-01	Vortex Rectifier (Lorain / Marconi) (V200D50), 24V Fan w/ 3 Wire Open End		
TF-MREC-02	Vortex Rectifier (Lorain/Marconi), 24V Fan & 3 Wire Plug (use in V200E50)		ATT.200003622
TF-RHM400-01	RHM-400/800 Rectifier Unit (Lorain/Marconi), 220VAC Fan		ATT.200006518
TF-LRA50B50-01	Lorain Rectifier (A50B50), 48V Fan w/ 2 Wire Plug		ATT.200005884
TF-LRV50B50-01	Lorain Rectifier (V50B50), 24V Fan w/ 3 Wire Plug		
LUCENT FANS (CBX500, DDM-2000, METROPOLIS, FT-2000, DACS III / IV)			
TF-CBX500-01	Lucent CBX500 OCD, 12V Cooling Fan w/ 3 Wire Pins		ATT.200003633
TF-FT201	Lucent FT-2000, 48V Fan w/ 3 Wire Plug		ATT.200005899
TF-DMXMET-01	Lucent Metropolis DMX, 48V Fan w/ 4 Wire Plug		ATT.200003131
TF-DMXMET-02	Lucent Metropolis DMX Access Multiplexer, 48V Fan w/ 4 Wire Black Plug		
TF-DDM201	Lucent DDM-2000, 24V Fan		ATT.200003128
TF-DDM201-KIT1	Lucent DDM-2000, 24V Fan Kit w/ Mounting Plate		ATT.200003126
TF-DDM202	Lucent DDM-2000, 48V Fan (use in Nidec T35078-LUC 440233, Comcode: 408741205)		ATT.200003127
TF-DACS3/4-01	Lucent DACS III / IV, 48V Fan w/ 4 Wire Plug (Equiv. to KS23913L1)		ATT.200000453
TF-DACS3/4-02	Lucent DACS III / IV, 48V Fan w/ 5 Wire Plug (Equiv. to KS23913L1)		ATT.200004391
TF-DACSK1-01	Alcatel-Lucent DACS K01, 48V Fan w/ 3 Wire Open End (includes (3) butt splices)		

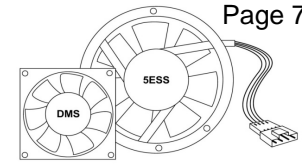

Part #	Description	
NEC FANS		
TF-NEC-01	NEC , 48V Fan (fan only) (FD-31201A / FD-32401A)	ATT.200003607
TF-NEC01-KIT1	NEC , 48V Fan Kit w/ Mounting & Grill (FD-31201A / FD-32401A)	ATT.200003623
TF-NEC-02	NEC , 48V Fan (fan only) (ITS-2400)	ATT.200003609
TF-NEC02-KIT1	NEC , 48V Fan Kit w/ Mounting & Grill (ITS-2400)	ATT.200003606
TF-NEC-03	NEC , 48V Fan (fan only) (ITS-2400V FL)	ATT.200003620
NORTEL FANS (DMS, Carrier VoIP, DPCC SuperNode "Squirrel Cage" Blowers)		
TF-DMS01	DMS-100 , 48V Fan w/ Power Prongs (use in NT3X90AC / NTB63AA fan trays)	ATT.200003630
TF-DMS02	DMS-1U , 48V Fan w/ Pwr Prongs (unthreaded) (use in NT3X90AC / NTB63AA trays)	ATT.200003608
TLMP-DMFA-10	DMS Fan Alarm Repl. Lamp, 24V ("Fan Fail" / "Frame Fail") (QTY of 10)	ATT.200008569
TLMP-DMFA-25	DMS Fan Alarm Repl. Lamp, 24V ("Fan Fail" / "Frame Fail") (QTY of 25)	ATT.200008570
TLMP-DMSA-10	DMS Aisle Alarm Repl. Lamp, 48V (QTY of 10)	ATT.200008572
TFT-DMS48KIT3	DMS-100 (NT3X90AA / NT3X90AB) , 24VAC to 48VDC Fan Tray Conversion Kit 3	ATT.200005900
TFT-DMS48KIT4	DMS-100 (NT3X90AA / NT3X90AB) , 24VAC to 48VDC Fan Tray Conversion Kit 4 (NEW KIT w/ Fan Control Board w/ built in Sensors (no paddles needed))	ATT.200006519
TFT-3X9013T ***NEW***	TAG Universal DMS-100 3X9013 Fan Tray (NEW TRAY is pre-assembled w/ (5) NEW fans, Alarm Board, Wiring Harness w/ Connector & Universal Mounting Holes for NT3X90AA, NT3X90AB, NT3X90AC & NT3X90AF cooling units) - No 24VAC Inverters - No Paddle Sensors	ATT.200010718
TF-DMS03	DMS-100 , 48V Fan w/ TTL Tach & 3 Wire Plug (use in NT3X90AF fan trays)	ATT.200003614
TFC-3X90AF-01	DMS-100, Fan Alarm Board for the NT3X90AF Cooling Fan Unit	ATT.200006499
TF-DMS04AC	DMS-100 , 24VAC Fan w/ Power Prongs (use in NT3X90AA / NT3X90AB fan trays)	ATT.200006516
TF-RX50FF-01	DMS SDM , 12V Fan w/ 3 Wire Plug & Speed Control (use in shelf # NTRX50FF)	ATT.200008573
TF-DMS-NTRX91	DMS-100 , 48V Fan (use in NTRX91AA / NTOX91AA (MVIE & CSDM bays), CLEI: ENMYACM)	ATT.200008092
TF-DMS10-01	DMS-10 , 48V Fan w/ Power Prongs	ATT.200008574
TF-DMS-FOS	Nortel IW SPM-IP , 48V Fan for NLX56AA Fan Assemblies (fan only)	ATT.200008577
TF-MG9K-01	Nortel / GENBAND Media Gateway 9000 , 48V Fan w/ 3 Wire Plug (use in NTTY18AA)	ATT.200008585
TF-DMSLGN6-01	DMS-500/250 DPCC (225mm) Impeller Fan for XA-Core Blower Drawer w/ 4 Wire Plug (fan only, use in existing tray # NTLX10AA, drawer # NTLX11AA)	ATT.200008590
TF-DMSMCL-02	DMS-100 Dual-Scroll Blower Replacement Unit (used in NT9X950 "w/ hanging blowers" (replaces # A0383325 & A0381714)) (found in DPCC / LIM / ENET bays)	ATT.200008095
TFC-DMSAPW-3	Alarm Board Replacement for DMS LIM / ENET Blower	ATT.200009341
TF-DMSLGN5A	DMS-100 DPCC XA-Core SuperNode Blower "Squirrel Cage" Replacement (includes 4 Wire Square Plug Adapter Cable) (use in NT9X01BC DPCC w/ Power Distribution Alarm Board (replaces A0345301))	ATT.200008587
TF-DMSLGN5	DMS-100 DPCC SuperNode Blower "Squirrel Cage" Replacement w/ Internal Sensor (use in NT9X01XX DPCC, (replaces A0345301))	ATT.100108587
SIEMENS EWSD FANS		
TF-EWSD-01	Siemens EWSD , Square 48V Fan w/ Power Prongs (fan only, use with existing grill)	ATT.200008579
TF-EWSD-02	Siemens EWSD , Round 48V Fan w/ Power Prongs (fan only, use with existing grill)	ATT.200008580
STROMBERG CARLSON DCO FANS		
TF-DCOCMF-01	48V Fan for Stromberg Carlson DCO CMF Bay w/ 3 Leads & Fastons	
TF-DCODCF-01	48V Fan for Stromberg Carlson DCO DCF Bay w/ 3 Leads & Spade Lugs	
TF-DCONHD-01	48V Fan for Stromberg Carlson DCO Non HD CMF Bay w/ 2 Wire Open End	ATT.200008581
TF-DCOMEF-01	48V Fan for Stromberg Carlson DCO MEF Bay (80mm x 45mm) w/ 3W Plug & Grill	ATT.200008583
TF-DCO-02	48V Fan for Stromberg Carlson DCO CMF / DTF Bay w/ 3 Leads & Fastons	ATT.200004392
STP RING NODE / WIDEBAND 3190 FANS		
TF-STPRN-01	STP Ring Node Frame/Cabinet , 48V Fan w/ 5 Wire Plug (use in Lucent J3F011AE fan unit, HECI E5DYAAC)	ATT.200006501
TF-WB3190	Wideband 3190 , 48V Fan w/ 3 Wire Plug	ATT.200006508

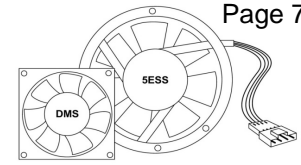

Part #	Description	
TELCO SYSTEMS FANS		
TF-EL100	Edgelink 100, Fan (40mm)	ATT.200003129
TF-EL100-KIT2	Edgelink 100, Fan Kit (40mm)	ATT.200003143
TF-EL100-02	Edgelink 100, Fan (35mm)	ATT.200003130
TF-EL330-01	Edgelink AXX330G1, Fan (80mm) w/ 3 Wire Plug	
OSP CABINET / TRAY FANS & ALARM CONTROL BOARDS		
TF-NTOPAC	48V Fan for Nortel Opac / OPM Cabinet w/ Round Weatherproof Connector	ATT.200002986
TF-NTOPAC-3	48V Fan for Nortel Opac / OPM Cabinet w/ 3 Wire Open End (no connector)	ATT.200002987
TF-NTOPAC-02	48V Fan for Nortel Opac / OPM Cabinet w/ Sealed 3 Pin Plug	ATT.200002988
TF-NTOPAC-04	48V Fan for Nortel Opac / OPM Cbnt w/ Sealed 3 Pin Plug (used with NT7A6986 adapter)	ATT.200008223
TF-NTOPAC-05F	48V Fan for Nortel Opac Access Node Tray w/ Pwr Prongs, Untermin. FPS	ATT.200008225
TF-NTOPAC-05	48V Fan for Nortel Opac Access Node Tray / 800A w/ 3W (FPS Lead) & 3 Pin	ATT.200008224
TF-NTANCFT-01	48V Fan for Nortel Access Node/Charles Fan Tray (w/ 3 Wire Plug)	ATT.200008228
TF-DMS06	48V Fan for BFU in DMS-100 OPM Cabinet w/ Power Prongs & Unterminated Tach (also used in DMS-1 URBAN EMC RT BAY (fan unit NT4A44AA))	ATT.200002989
TF-SLC201-02	48V Heat Exchanger for 80 Type Cabinet w/ Round Connector (KS23912L4)	ATT.200002995
TFC-114A-01	114A Fan Control Unit for 80 Type Cbnt Heat Exchangers (equiv. to 106894934)	ATT.200006506
TFC-LU4-01	Alarm Control Board for Lucent 4A/4B, 4G/SLC2000 Fan Trays & 114A	ATT.200004557
TF-SLCBC-01	48V Battery Cooling fan for 80 Type Cabinet w/ 3 Wire Plug	ATT.200006505
TFC-116A-01	Alarm Control Board for Lucent 116A Battery Fan Unit (customer supplied bkt)	ATT.200006502
TF-SLC201	48V Fan for SLC 2000 4A/4B Tray w/ 5 Wire Plug (KS23912L6)	ATT.200002993
TFCS-LU4APA-06	Power Cable for Lucent 4A/4B Fan Tray, (6')	ATT.200008566
TF-SLCAPW-01	(1) 48V Fan for SLC 2000 Cbnt Reltec / Mclean APW Tray (for UJB17H48S22)	ATT.200005892
TF-SLCAPW-04	(4) 48V Fans for SLC 2000 Cbnt Reltec / Mclean APW Tray (for UJB17H48S22)	ATT.200006511
TFC-SLCAPW-4	Alarm Control Board for Reltec / Mclean APW Fan Tray	ATT.200008220
TF-LU2A	48V Fan for Lucent 2A Fan Tray w/ 3 Leads & Fastons (KS22501L5)	ATT.200002994
TF-LU2B	48V Fan for Lucent 2B Fan Tray w/ 3 Wire Plug (KS22501L5A Equiv.)	ATT.200002996
TFC-LU2BC-01	Alarm Control Board for Lucent 2B & 2C Fan Trays (customer supplied fan trays)	ATT.200006513
TF-LU2C	48V Fan for Lucent 2C Fan Tray w/ 3 Wire Plug (KS22501L5A Equiv.)	ATT.200002997
TF-LU2C-02F	48V Fan for Lucent 2C Fan Tray w/ 3 Wires & Faston Connectors	ATT.200009333
TFCS-2BPWRY-01	Power Cable "Y" for Lucent 2B & 2C Fan Trays w/ 1 (M) Conn. to (F) "Y", (1')	ATT.200006909
TFCS-2BRS-08	Remote Sensing Daisy Chain Cable for Lucent 2B & 2C Fan Trays,(8')	ATT.200006910
TF-ES660-01	24V (60x25mm) Fan for Lucent ES660 Rectifier Unit w/ 2 Wire Plug	
TFT-SLC96-AC01	110VAC Fan w/ Bracket Assembly for SLC96 (36 Type) Cabinet (KS22099L5)	ATT.200008234
TFT-SLC96-AC01L	110VAC Fan (Low Temp) w/ Bracket Assembly for SLC96 (36 Type) Cabinet (KS22099L5)	ATT.200008235
TF-SLC96-AC02	110VAC Fan (fan only) for SLC96 (36 Type) Cabinet (use in KS22099L5)	ATT.200004398
TF-ALC7330-4	Alcatel 7330 VRAD Fan Kit, (4) 48V Fans w/ Quick Install Template Plate	ATT.200002985
TF-ALC7330-C	(1) 48V Fan for Alcatel 7330 VRAD Tray w/ 3 Wire Open End (for splicing)	ATT.200002984
TF-ALC1218-01	24V Fan for Alcatel 1218 Cabinet Fan Tray w/ 2 Wire, 3 Pin Connector	
TF-ALC1218-02	48V Fan for Alcatel 1218 Cabinet Roof w/ 2 Unterminated Leads	
TF-PURALP-01	48V HX for ALP-248/448 (Purcell) Cbnt Door (Bottom) & Battery w/ 4W Plug	ATT.200006510
TF-PURALP-02	48V HX for ALP-248/448 (Purcell) Cbnt Door (Top) w/ 4 Wire Plug & Grommet	ATT.200009344
TFCS-PURVPWR-05	Power Cable for Purcell VRAD Cabinet, (5') (use w/ MAIP controllers)	ATT.200008096
TFCS-PURVPWR-06	Power Cable for Purcell VRAD Cabinet, (6') (use w/ MAIP controllers)	ATT.200008229
TF-PURALP148-01	48V HX for ALP-148E (Emerson) Cabinet Door (Top) w/ 4 Wire Male Plug	ATT.200006512
TFC-248E-01	Battery Vent Fan Control Board for (Emerson) ALP-248E/448E Cabinets	ATT.200009342
TFC-CALIX2KHX	Alarm Control Board for Calix ODC-2000 Cabinet HX Controller (alarm board only)	
TFCS-CLX2KHX	Power Cable for Calix ODC-2000 Cabinet HX Controller (equiv. to 315-00420)	
T-DFAB-02	2 Channel (-48VDC) Fan Tray Alarm Converter (-48VDC to Ground Alarm)	ATT.200010348
T-DFAB-05	(+5VDC) Fan Tray Alarm Converter (+5VDC to Ground Alarm)	ATT.200010347

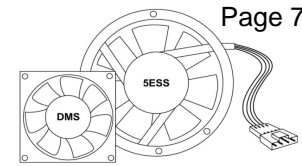

Part #	Description	
OSP CABINET / TRAY FANS & ALARM CONTROL BOARDS - continued from previous page		
TF-COM6DF-01	48V Fan for CommScope Cbnt, 6D/F Bay, VAUCADY w/ internal sensor & 3 Wire, 6 Pin	ATT.200004404
TF-COM6DF-02	48V Fan for CommScope Cabinet, ALP HX Door w/ 5 Wire, 6 Pin Connector	ATT.200006509
TF-COM6DF-02R	48V Fan for CommScope 52/82 Cbnt, HX Door w/ 5 Wire, 6 Pin (w/ 10k thermistor cable)	ATT.200008219
TFCS-COM6TR	10k Thermistor Extension Cable for CommScope 52/82 Type Cabinet, HX Door Fan	
TFCS-COM6TA-01	100k Thermistor Extension Cable for CommScope 52/82 Cbnt, HX Door Fan	ATT.200010346
TFCS-COM6X-01	Adapter Cable for CommScope 6F Fans, 3 Wire 6 Pin to 4 Pin	ATT.200010345
TF-COM6DF-04	48V Fan for CommScope Cbnt, 6D/F Bay, VAUCADY w/ internal sensor & 3 Wire, 4 Pin	ATT.200008221
TF-COM6BC-01	48V Fan for CommScope Cbnt, 6B/C Battery / ALP HX Door w/ 3 Wire, 4 Pin Conn	ATT.200005885
TF-COM52E-01	48V Fan for CommScope 52E Cbnt, Battery w/ (1) 2 Wire, 4 Pin Conn & (1) 2 Wire, 2 Pin	ATT.200008222
TFT-COM48B-01	"Salt Air Door Fan Tray" 3 Fan Stainless Steel Assembly for CommScope ALP 448/248 HX Door Fans (includes: (3) NEW 48V FANS & Grommet)	ATT.200010349
TFT-COM48B-02	Stainless Steel Plate for CommScope ALP 448/248 HX Door Fans (plate only)	ATT.200010350
TF-NP0402-01	48V HX for Noren Cooling Unit - Internal (6.71K) w/ 3 Wire Open End	ATT.200004561
TF-NP0414-02	48V HX for Noren Cooling Unit - External (8.45K) w/ 3 Wire Open End	ATT.200004560
TF-FUJ6200-01	48V Heat Exchanger for Fujitsu 6200 Cabinet w/ 5 Wire Plug	ATT.200002981
TF-FUJ6200-02	48V Fan for Fujitsu 6200 Cabinet Tray w/ Power Prongs	ATT.200008226
TF-FUJ6200-03	48V Fan for Fujitsu 6200 Cabinet Tray w/ 3 Wire Open End & Power Prongs	ATT.200009340
TF-AI-SCT-01	48V (80mm) Fan for AISCOUT w/ 3 Wire Right Angle Plug	ATT.200009336
TF-ALC7342-01	48V Fan for Nokia 7342 Rolt Tray w/ 4 Wire Plug	ATT.200008582
TF-OPTI-01	12V Fan for Opti 6100 Trays w/ 3 Wire Plug (use in EFANM Fan Tray # 1184508L2)	ATT.200008589
TF-CN5150HX-01	48V HX for Telamon / Ciena 5150 EMUX Cbnt Door w/ 4 Wires & Seated Connector	ATT.200008097
TFT-CN5140-01	Ciena 5140 Fan Tray Replacement	ATT.200011697
TF-DISCSCPU-01	48V Cooling Fan for DISC*S CPU w/ 2 Wire Open End (includes (2) butt splices & cable ties) (fan only)	
TF-LS2000-01	48V Fan for Litespan 2000 PDFA w/ 3 Wire Plug & Grill (use in # 500-1126-723)	ATT.200002982
TFC-PDFA-X2	Alarm Control Board for LS2000 PDFA Fan Trays (equiv. to # 300-8205-900)	ATT.200009885
TF-LS2000-02	48V Fan for Litespan 2000 HV PDFA w/ 3 Wire Connector (use in 509-0000-XXX)	ATT.200002983
TFC-PDFA-01	Alarm Control Board for Litespan 2000 High Velocity PDFA Fan Trays	ATT.200009332
TF-LS2000-03	48V Heat Exchanger for Litespan 2000 Cabinet w/ Unterminated Leads	ATT.200004394
TF-LS2KSB-01	48V Heat Exchanger for Litespan 2000 Cabinet Heat Stack w/ Power Prongs	
TF-LS2000-44	Litespan 2000 DFA Fan Kit, includes: (4) 48V Fans & Harness (use in # 500-1100-XXX)	ATT.200004556
TF-LS2000-04	(1) 48V Fan for Litespan 2000 DFA w/ 3 Wire Open End	ATT.200004558
TFC-DFA-01	Alarm Control Board for Litespan 2000 DFA Fan Trays (use in # 500-1100-XXX)	ATT.200006507
TF-ACABTZ-01A	48V HX (Tarzan) for Litespan 2000 (LSC-2030) Cabinet w/ Adapter Cable	ATT.200003610
TF-ACABLHX-01	48V Heat Exchanger (Lower) for Litespan 2000 LSC-2030 Cabinet	ATT.200008231
TF-LRA25B50-01	24V Fan for A25B50 Rectifier Unit (Lorain / Marconi) w/ 3 Wire Plug	ATT.200011699
TF-LPCM-01	24V Fan (80mm) for Lorain V15F50/P Power Conversion Module (fan only)	ATT.200008584
TF-LPM-01	48V Fan for Lorain Power Module w/ Power Prongs (fan only - for 427215900)	ATT.200004559
TF-MESACL-01	48V Fan for Marconi Current Limiter w/ 3 Wire Plug	ATT.200008091
TF-MCABTZ-01	48V HX (Tarzan) for Marconi Mesa "Top" HX Cabinet w/ 3 Wire Plug	ATT.200003621
TFCS-MATP	Mesa Alarm Test Plug (PACK OF 6) (used to troubleshoot fans at the Mesa 6 ECU)	ATT.200010351
TF-MESA6-01	48V HX for Marconi Mesa "Bottom" HX Cabinet w/ 3 Wire Plug	ATT.200004564
TF-MARCTOP-01	48V Fan for Marconi Cabinet (Top/Inside) w/ Power Prongs	
TFC-FA400-01	Alarm Control Board Replacement for Marconi Mesa Master Tray	ATT.200008571
TF-FA400-01	48V Fan for Marconi Mesa Cabinet Master Fan Tray w/ 3 Wire Plug	ATT.200005890
TF-FA400-02	48V Fan for Marconi Mesa Cabinet Slave Fan Tray w/ 3 Wire Plug	ATT.200005888
TFC-MARC6-01	6 Position Environmental Ctrl Unit (ECU) for Marconi Cbnt (support 6 HX fans)	ATT.200008567
TFC-WORX-FAM1	PowerWorx Front Access Fuse Panel (Equiv. to ADC # TFA-FAM)	ATT.200006504
TF-SPB-AC01	120VAC Fan for Seiscor / Pulsecom "B" Cabinet w/ Power Prongs	
TF-SPD-AC01	110VAC Fan for Seiscor / Pulsecom "D" Cabinet w/ Power Prongs & Guard Grill	
TF-DCORLS-01	48V Fan for Stromberg Carlson DCO RLS Cabinet Tray w/ 3 Fastons & Power Prongs	
TF-RSC48-01	48V Heat Exchanger for Tellabs RSC48 Cabinet w/ 2 Wire Plug	ATT.200011698

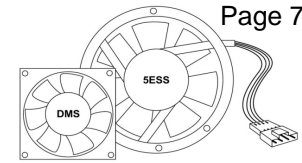

Part #	Description	
OSP CABINET / TRAY FANS & ALARM CONTROL BOARDS - continued from previous page		
TF-UMC1000-01	48V Fan (120mm) for Tellabs UMC1000 Tray w/ 3 Wire Plug (use in AFC Tray w/ 6 fans)	ATT.200006913
TFC-UMC1000-06	Alarm Control Board for Tellabs UMC1000 6 Fan Tray	ATT.200009886
TF-UMC1000-02	48V Fan (80mm) for Tellabs UMC1000 Tray w/ 3 Wire Plug (use in AFC Tray w/ 10 fans)	ATT.200008094
TF-UMC1000-03	48V Fan (120mm) for Tellabs UMC1000 Tray w/ 4 Wire Plug (use in Tellabs Tray w/ 8 fans)	ATT.200008233
TF-UMC672-01	48V Fan for UMC672 Cabinet w/ 2 Wire Plug (fan only, use with existing metal housing)	
TF-MC133-02	(133mm) HX for Mesa 768 Cabinet w/ 3 Pin Plug (fan only)	ATT.200004405
TF-MC133-05	(133mm) HX for Mesa Sport Cabinet w/ 3 Pin Bulkhead Plug	ATT.200008236
TF-CSHX133-01	(133mm) HX for Mesa Sport Cabinet w/ 4 Pin Male Weatherproof Plug (fan only)	ATT.200006914
TF-MC133-01	(133mm) HX for Purcell FlexAir 741 Cbnt (Door) w/ 4 Leads & Fastons	ATT.200004388
TF-MC175-04	(175mm) HX for Purcell A009 Cabinet w/ Weatherproof Conn. (fan only)	ATT.200004555
TF-MC175-04-KIT	(175mm) HX KIT for Purcell A009 Cabinet w/ Wthprf Connector & Bracket	ATT.200004577
TF-SRA200-01	(175mm) Heat Exchanger for SRA-200 Cabinet w/ 3 Wire Plug (fan only)	
TF-MC175-02	(175mm) Heat Exchanger for Cell Site Mesa 4 NXT Cabinet w/ 3 Wire Plug	ATT.200004403
TF-MC175-03	(175mm) Heat Exchanger for Cabinet w/ 3 Pin Plug (fan only)	ATT.200004389
TF-MC175-01	(175mm) Heat Exchanger For Siemens 914EX Metro MXU Cabinet w/ 2 Wire Open End (fan only)	
TF-914EHX-01	48V Heat Exchanger for Siemens 914E RT Cabinet w/ Power Prongs	
TF-914EXMET-01	48V Fan for Siemens 914EX Metro MXU Fan Tray w/ Power Prongs	
TF-TA5KHX-02	48V "Low Profile" Heat Exchanger for Adtran TA5000 Cabinet Door w/ 4 Wire Plug	
TF-HX175LP-01	(175mm) "Low Profile" HX for Calix ODC Cabinet Door w/ Grommet, 4 Leads & Fastons	
TF-HX220LP-01	(220mm) "Low Profile" HX for Calix ODC-1000 Cbnt w/ 4 Leads & Fastons	
TF-OPM640HX	(175mm) "Low Profile" HX for OPM 640 Cabinet (Retro Fit Roof) w/ 3 Wire, 4 Pin Plug	
TF-AFCHX-01	(175mm) "Low Profile" HX for AFC Fan Unit found in OPM Cabinets w/ 2 Wire, 4 Pin Plug	
TF-CATNHX-01	(175mm) "Low Profile" HX for Catena Cabinet w/ (1) 2 Wire Plug & (1) 3 Wire, 4 Pin Plug	
TF-MC179-01A	Heat Exchanger for Mesa Bridge Cabinet (Upper - Internal) w/ 4W (F) Weatherproof Plug	
TF-MC179-01	Heat Exch. for Mesa Bridge Cabinet (Lower - Door) w/ 4W (F) Wthprf Plug	ATT.200006912
TF-CQ250-01	(250mm) Heat Exchanger for Ice Qube Cabinet w/ 4 Wire Open End	ATT.200009347
TF-AFC672-01	48V Fan for AFC Cabinet Heat Stack w/ Power Prongs	ATT.200008227
TF-CLX225-01	(225mm) HX Impeller Fan (Upper) for Calix ODC Cabinet w/ 4 Wire Female Plug, (14" cable)	
TF-CLX225-02	(225mm) HX Impeller Fan (Upper) for Calix ODC Cabinet w/ 4 Wire Female Plug, (30" cable)	
TF-CLX225-03	(225mm) HX Impeller Fan (Lower) for Calix ODC Cabinet w/ 4 Wire Male Plug, (30" cable)	
TF-CLX133-01	(133mm) HX Impeller Fan (Upper/Lower) for Calix Cabinet w/ 4 Wire Plug	
TF-CLXODC-01F	48V Heat Exchanger for Calix ODC Stack w/ 2 Wires & Fastons	
TF-TX38HX-01	(225mm) HX for McLean ClimaGuard Cabinet Cooler w/ 4 Wire Weatherproof Connector	
TF-TX33HX-01	(175mm) HX for McLean ClimaGuard Cabinet Cooler w/ 4 Wire Weatherproof Connector	
TF-MCCHX-AC01	110VAC HX Blower for Reltec / McLean Cabinet w/ Power Plug & Adapter Plate (fan only)	
TF-MCCHX-AC0R	110 VAC HX (Right) Blower for Reltec/McLean Cabinet w/ Power Plug & Adapter Plate (fan only)	
TF-ES660-01	24V (60x25mm) Fan for Lucent ES660 Rectifier Unit w/ 2 Wire Plug	
TF-RECARGUS-01	12V (80mm) Fan for Argus Rectifier w/ 2 Wire Plug	ATT.200009346
TF-RECARGUS-02	24V (80mm) Fan for Argus Rectifier w/ 2 Wire Right Angle Plug	ATT.200009348
TF-RECARGUS-03	24V (80mm) Fan for Argus Rectifier w/ 2 Wire Right Angle Plug (threaded inserts)	ATT.200009345
TF-RECARGUS-04	12V (120mm) Fan for Argus Rectifier w/ 2 Wire Open End	
TF-MESA384-01	48V (Top External) HX for Mesa DSLAM 384 Cbnt w/ 4W Rnd (F) Wthprf Plug	ATT.200004565
TF-MESA384-02	48V (Internal) HX for MESA 384 Cbnt w/ 4 Wire Square Female Plug	ATT.200008230
TFC-MESA-04	4 Port ECU (used in Mesa 2 - DSLAM 192 & DSLAM 384 Type Cabinets)	ATT.200006902
TFC-MESA-02	2 Port Environmental Control Unit (ECU) (used in Mesa 2-DSLAM 192 Type Cabinet)	ATT.200006901
TFC-MESA246-01	6 Fan Environmental Control Unit (ECU) for Remote Cabinet Sites	ATT.200006905
TFCS-MESA246-08	Extension Cable for Mesa Fan Controllers found in Mesa, 52, 192 & 384 type cabinets	ATT.200006907
TFCS-M225TP	Extension Cable for Mesa 246 ECU to Upper Cabinet Fan , (20')	ATT.200009335
TF-MC225-01	(225mm) Heat Exch. for Mesa Cabinet (Top) w/ Round Wthprf Plug (fan only)	ATT.200002990
TF-MC225-02	(225mm) Heat Exchanger for Mesa Cabinet (Bottom) w/ 4 Wire Plug (fan only)	ATT.200002991
TF-MC225-02-KIT	(225mm) Heat Exch. KIT for Mesa Cabinet (Bottom) w/ 4 Wire Plug & Bracket	ATT.200002992
TFC-MESA-01	2 Port Mesa Cell Site Cabinet ECU (used in: XL, SOLE, Span XL, Bridge, Edge & Sport)	ATT.200008586
T-DFAB-02	2 Channel (-48VDC) Fan Tray Alarm Converter (-48VDC to Ground Alarm)	ATT.200010348
T-DFAB-05	(+5VDC) Fan Tray Alarm Converter (+5VDC to Ground Alarm)	ATT.200010347

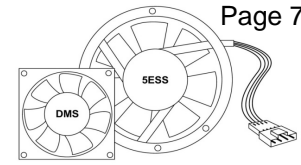

Part #	Description	
TAG REPAIRS, 30+ New Items Available for AT&T (FOLLOW REPAIR PROCESS THROUGH UPFRONT)		
TFR-ALC7330-01	Fan Assembly TAG, Alcatel 7330 VRAD (HECI: VAPQAFZFxx) (3FE 24322 (XXXX))	UPFRONT REPAIRS
TFR-LU2A-01	Fan Assembly TAG, 2A Lucent Fan Tray	UPFRONT REPAIRS
TFR-LU2B-01	Fan Assembly TAG, 2B Lucent Fan Tray (COMCODE: 105550420)	UPFRONT REPAIRS
TFR-LU2C-01	Fan Assembly TAG, 2C Lucent Fan Tray (COMCODE: 106382336 / 109198341)	UPFRONT REPAIRS
TFR-LU4A-01	Fan Assembly TAG, 4A Lucent Fan Tray (COMCODE: 106526742)	UPFRONT REPAIRS
TFR-LU4G-01	Fan Assembly TAG, 4G Lucent Fan Tray (COMCODE: 107378036)	UPFRONT REPAIRS
TFR-LU4B-01	Fan Assembly TAG, 4B Lucent Fan Tray (COMCODE: 106527005)	UPFRONT REPAIRS
TFR-COM6F-01	Fan Assembly TAG, 6F CommScope Fan Tray (HECI: VAUCADYxxx)	UPFRONT REPAIRS
TFR-SLCAPW-01	Fan Assembly TAG, McLean/Reltec SLC APW (Tray # UJB17H48S22)	UPFRONT REPAIRS
TFR-LS2000-02	Fan Assembly TAG, Litespan 2000 HV PDFA (Tray # 509-0000-086 & 509-0000-163)	UPFRONT REPAIRS
TFR-LS2000-44	Fan Assembly TAG, Litespan 2000 DFA (Tray # 500-1100-400)	UPFRONT REPAIRS
TFR-ALC1000-01	Fan Assembly TAG, Alcatel 1000 ADSL Fan Tray PN 3EC15478 (HECI: VAMYAAMGAA)	UPFRONT REPAIRS
TFR-UMC1000-06	Fan Assembly TAG, Tellabs UMC1000, 6 Fan Tray (Tray # 0310-1716 or 8650-0414)	UPFRONT REPAIRS
TFR-UMC1000-08	Fan Assembly TAG, Tellabs UMC1000, 8 Fan Tray (Tray # 4195091)	UPFRONT REPAIRS
TFR-UMC1000-10	Fan Assembly TAG, Tellabs UMC1000, 10 Fan Tray (Tray F10 # 0310-1716)	UPFRONT REPAIRS
TFR-FA400-04	Fan Assembly TAG, Marconi Fan Tray FA400 Master Fan Unit (P/N# FA-400-175-001)	UPFRONT REPAIRS
TFR-CN5140-01	Fan Assembly TAG, Ciena 5140 Fan Tray	UPFRONT REPAIRS
TFR-114A-01	Fan Assembly TAG, 114A Lucent Control Unit for Heat Exchanger Fans (COMCODE: 106894934)	UPFRONT REPAIRS
TFR-MARC6-01	Fan Assembly TAG, Marconi/Degree ECU HX Fan Control Unit (P/N# ECU-05682,105683,105684)	UPFRONT REPAIRS
TRR-GSB-48V	Battery TAG, Midtronics String Charge Control Device (P/N GSB-48V)	UPFRONT REPAIRS
TRR-MBC-5641	Battery TAG, Marconi String Charge Control Device (P/N MBC-5641)	UPFRONT REPAIRS
TRR-LXPC-01	Rectifier TAG, LORAIN LXC300 LX Controller Repair HECI / CLEI: PBP3Q8VDTA	UPFRONT REPAIRS
TRR-LXP1500	Rectifier TAG, LORAIN LXP1500 Power Supply Repair HECI / CLEI: PWPCH9TPAA, SLP1AADBAA, PBP3F05DAA	UPFRONT REPAIRS
TRR-LXP1750	Rectifier TAG, LORAIN LXP1750 Power Supply Repair HECI / CLEI: PBP3FPMDAA, PBP3FNMDAA	UPFRONT REPAIRS
TRR-LV15F50-01	Rectifier TAG, LORAIN V15F50/P Rectifier, HECI / CLEI: PBPU0Y2AA	UPFRONT REPAIRS
TRR-CPS6K-01	Rectifier TAG, TYCO CPS6000 Rectifier Repair PBP4AC2 - RECTIFIER 15 AMP, QS861ATEZ	UPFRONT REPAIRS
TRR-CPS6K-02	Rectifier TAG, TYCO CPS6000 Rectifier Repair PBP4AC3 - RECTIFIER 25 AMP, QS862ATEZ	UPFRONT REPAIRS
TRR-CPS6K-03	Rectifier TAG, TYCO CPS6000 Rectifier Repair PBP4AC4 - RECTIFIER 30 AMP, QS863ATEZ	UPFRONT REPAIRS
TRR-VAL20A-01	Rectifier TAG, ELTEK VALERE V1000A Rectifier 48V, 20 AMP, HECI / CLEI: PBP2DCTBAA	UPFRONT REPAIRS
TRR-RG3C1	Ring Generator TAG, AT&T/LUCENT 3C1 Ring Generator HECI / CLEI: 5SCB644DAB, 5SCB644DAE	UPFRONT REPAIRS
TRR-RG3H1	Ring Generator TAG, AT&T/LUCENT 3H1 Ring Generator HECI / CLEI: 5SCBPE0DAD	UPFRONT REPAIRS
TRR-RGV100BR	Ring Generator TAG, LORAIN V100BR Ring Generator HECI / CLEI: PRPUAF01AA	UPFRONT REPAIRS
TRR-PCU-01	DISCS TAG, PCU Refurbishment MARCONI / RELTEC / TELLABS Power Control Unit	UPFRONT REPAIRS
TRR-LVD-01	Battery TAG, Low Voltage Disconnect (LVD) Marconi/Reltec Shelf (P/N# 73-16-598)	UPFRONT REPAIRS

Don't see the fan you are looking for? Send us a sample & we will find a match!

PLEASE CALL: 856-753-8585 or EMAIL: custsvcs@tagcords.com

TAG DMS-100 3X9013 Universal Fan Tray

TFT-3X9013T

Universal 48VDC Fan Tray

- **No 24VAC Inverters**
(24VAC inverters cause heat concerns & major equipment failures)
- **No Mechanical Sensors**
(sensor paddles are known to bend & break)

INSTALLATION VIDEOS:



NT3X90AA/AB



NT3X90AC



NT3X90AF

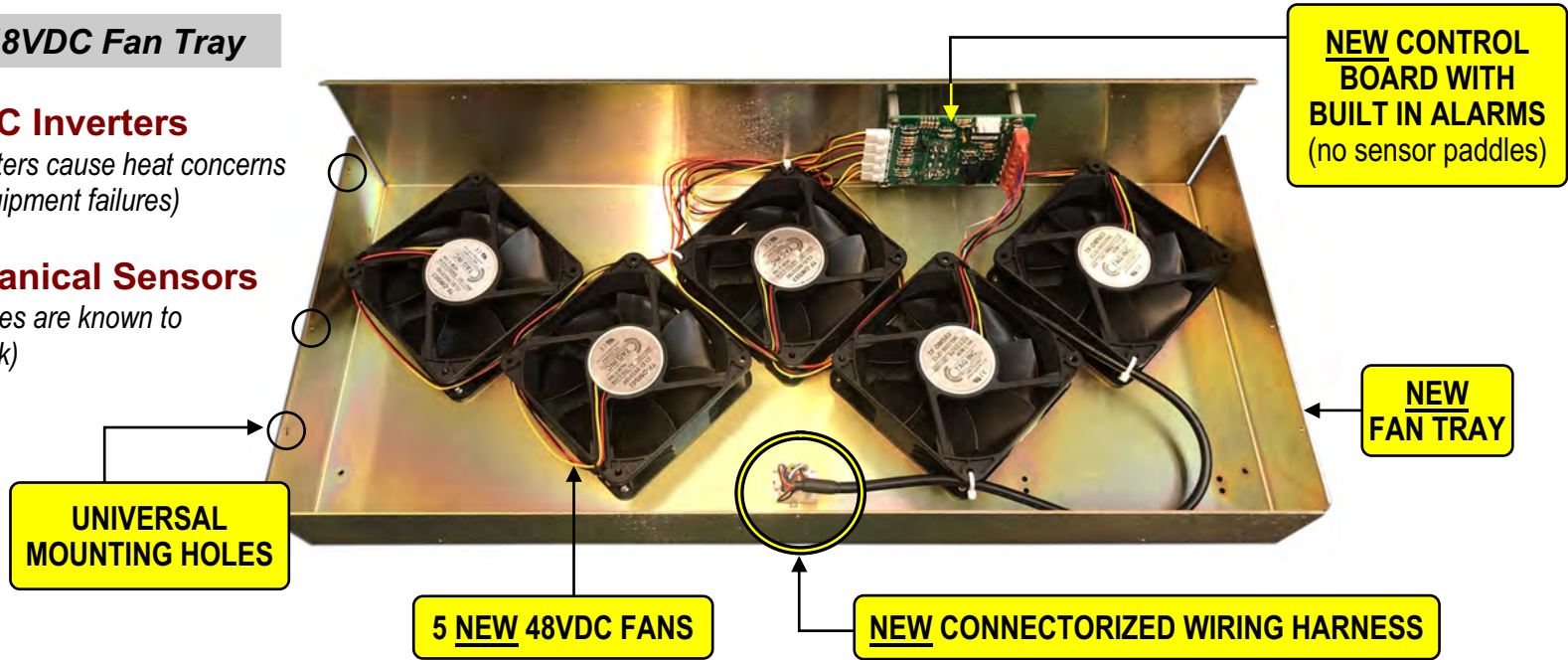

- Connectorized Universal metal tray with Fan Alarm Board (no sensor paddles)
- Pre-assembled & works with NT3X90AA, NT3X90AB, NT3X90AC & NT3X90AF Cooling Units
- Adapter cables* are supplied for NT3X90AA/AB & NT3X90AF Cooling Units
**(adapter cables are not used with NT3X90AC)*

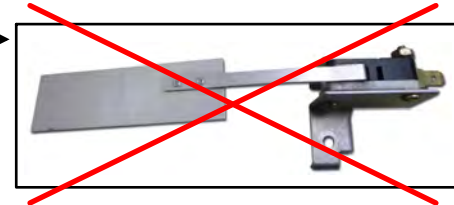

Ordering Information:

TFT-3X9013T

TAG Universal DMS-100 3X9013 Fan Tray

AT&T PID #
ATT.200010718

Includes: (1) Brand New Fan Tray w/ Universal Mounting Holes,
(5) TF-DMS03, 48VDC Fans w/ TTL Tach & 3 Wire Plug,
(1) Fan Control Board w/ Built in Sensors (no paddles needed), Wiring Labels, Mounting Hardware,
(1) Wiring Harness w/ Connector, NT3X90AA/AB & NT3X90AF Adapter Cables & Installation Guide

150 Cooper Rd. (F-15)
W. Berlin, NJ 08091

www.tagcords.com
Telecom Assistance Group

Telephone: (856) 753-8585
Fax: (856) 768-7645