

# Lumen/CenturyLink 2025 Product Ordering Guide

[Issue 1.0](#)

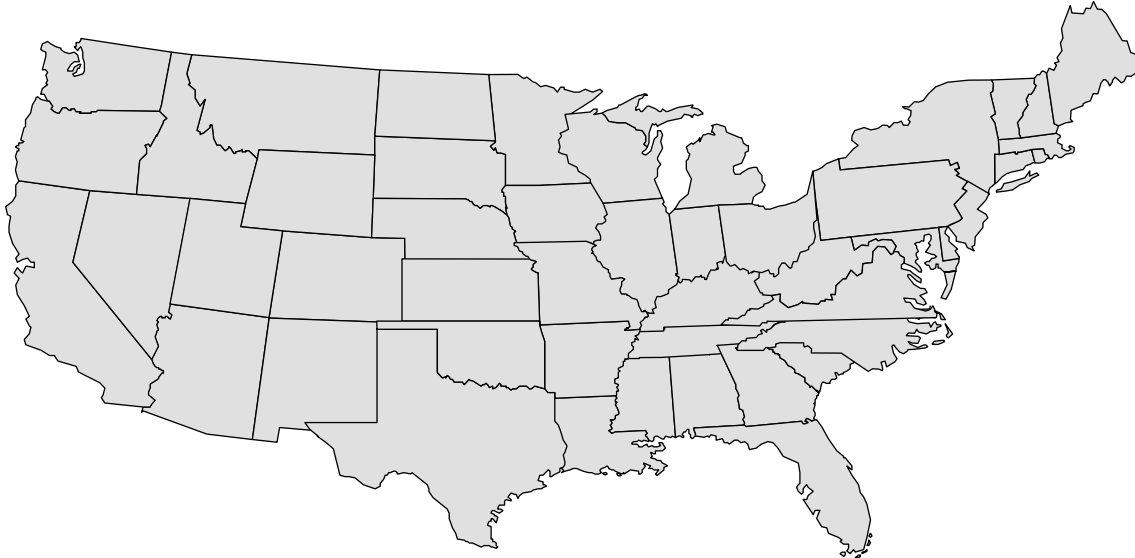

Provided By:



The "Cord Company" and more . . .

## "TEST CORDS & ADAPTERS"



## "T1 REPEATERS & EXTENDERS"

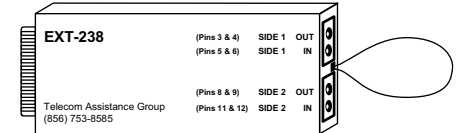

## "DUMB TERMINALS"



## "FANS"

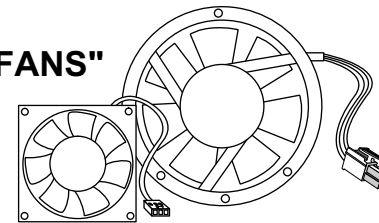

## "NEBS CERTIFIED SOLID STATE SCSI DRIVES"



**FAN TRAY REPAIRS**









**SAP CODES FOR ERT PROCESSING**

[www.tagcords.com](http://www.tagcords.com)

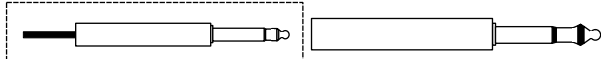

-





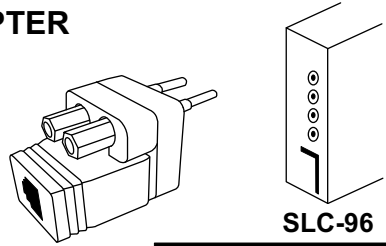
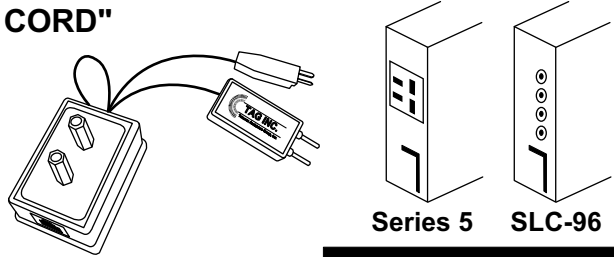
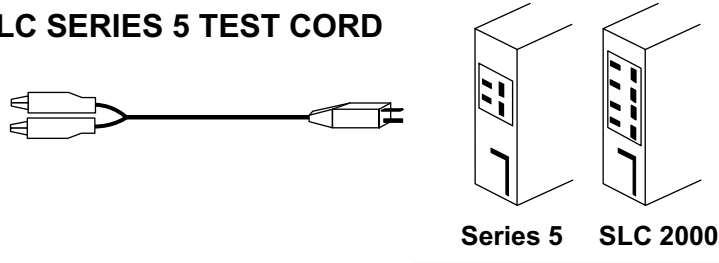
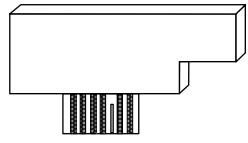

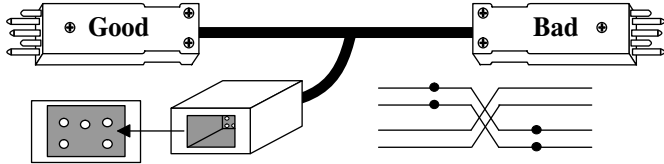
**856-753-8585**





FEATURES / APPLICATION	PART #	DESCRIPTION
<p><b>Bantam to (2) Alligator Clips, (2')</b>  <b>Bantam to (2) Alligator Clips, (6')</b></p> <ul style="list-style-type: none"> <li>Access to various connectors, bare cable</li> </ul>	<p><b>ST400210A-02</b>  <b>ST400210A-06</b></p>	<p><b>BANTAM to ALLIGATOR CLIPS</b></p>  <p><b>2'</b> MAT # 1157471  <b>6'</b> MAT # 1157472</p>
<p><b>310 to (2) Alligator Clips, (6')</b></p> <ul style="list-style-type: none"> <li>Access to various connectors, bare cable</li> </ul>	<p><b>ST400310A-06</b></p>	<p><b>310 to ALLIGATOR CLIPS</b></p>  <p><b>MAT # 1157464</b></p>
<p><b>310 to 310, (6')</b></p> <ul style="list-style-type: none"> <li>General purpose test/patch cord</li> <li>Available in various lengths</li> </ul>	<p><b>400310</b></p>	<p><b>310 to 310</b></p>  <p><b>MAT # 1157468</b></p>
<p><b>Bantam to 310 Conversion Plug</b></p> <ul style="list-style-type: none"> <li>Slides over Bantam Plug converting it to a 310</li> </ul>	<p><b>400239</b></p>	<p><b>BANTAM TO 310 CONVERSION PLUG</b></p>  <p><b>BANTAM</b>      <b>400239</b></p> <p><b>MAT # 1157438</b></p>





FEATURES / APPLICATION	PART #	DESCRIPTION
<p><b>Bantam to Bantam - Black, (6')</b>  <b>Bantam to Bantam - Red, (6')</b></p> <ul style="list-style-type: none"> <li>Patching or Test Set Application</li> <li>Red/Black colors for Transmit/Receive</li> </ul>	<p><b>400210BK</b>  <b>400210RD</b></p>	<p><b>BANTAM to BANTAM</b>  <b>BANTAM to BANTAM</b></p>  <p><b>BLACK</b>  <b>RED</b></p> <p><b>MAT # 1157483</b>  <b>MAT # 1157482</b></p>
<p><b>Bantam Looping Plug</b></p> <ul style="list-style-type: none"> <li>3 conductor looping plug</li> </ul>	<p><b>400210LP</b></p>	<p><b>BANTAM LOOPING PLUG</b></p>  <p><b>MAT # 1157492</b></p>
<p><b>Bantam to Wire Wraps, (6')</b></p> <ul style="list-style-type: none"> <li>Slides on standard CO terminal block pins (.045) for test access</li> </ul>	<p><b>400210WP</b></p>	<p><b>BANTAM to WIRE WRAPS</b></p>  <p><b>MAT # 1102718</b></p>
<p><b>Wire Wraps to Mini Alligator Clips, (1')</b></p> <ul style="list-style-type: none"> <li>Slide wire wrap over CO mounting Block Pins</li> <li>Alligator clips allow connections to various equipment (Butt-Set, Caller ID, and ADSL Applications)</li> </ul>	<p><b>400200MA-01</b></p>	<p><b>WIRE WRAPS to MINI ALLIGATOR CLIPS</b></p>  <p><b>MAT # 1157487</b></p>

FEATURES / APPLICATION	PART #	DESCRIPTION
<p><b>SLC-96 Line Adapter</b></p> <ul style="list-style-type: none"> <li>Hollow post and/or modular access to Odd/Even Channels at faceplate of SLC-96 channel units or DISC*S</li> </ul>	<p><b>400396-2M</b></p>	<p><b>SLC-96 LINE ADAPTER</b></p>  <p><b>MAT # 1157437</b></p>
<p><b>"The SLICK CORD", (2')</b></p> <ul style="list-style-type: none"> <li>Dual Purpose cord for Series 5/SLC 2000 and/or SLC-96/DISC*S faceplate access</li> </ul>	<p><b>4003956</b></p>	<p><b>"SLICK CORD"</b></p>  <p><b>MAT # 1157496</b></p>
<p><b>SLC Series 5 Test Cord, (1')</b></p> <ul style="list-style-type: none"> <li>Dial tone access at faceplate of Series 5 or SLC 2000</li> </ul>	<p><b>400395-2</b></p>	<p><b>SLC SERIES 5 TEST CORD</b></p>  <p><b>MAT # 1157500</b></p>
<p><b>SLC-96 Looping Plug</b></p> <ul style="list-style-type: none"> <li>Loops SLC-96 circuits</li> </ul>	<p><b>400396L</b></p>	<p><b>SLC-96 LOOPING PLUG</b></p>  <p><b>MAT # 1157501</b></p>

FEATURES / APPLICATION	PART #	DESCRIPTION
<p><b>463A Plug to Alligator Clips, (2')</b>  <b>463A Plug to Alligator Clips, (6')</b></p> <ul style="list-style-type: none"> <li>• Long pins wired to Alligator clips</li> <li>• Non-bridging - Flip to look both ways 463A type plug (protector) to alligator clips</li> <li>• Similar to W2GL</li> </ul>	<p><b>ST400300S-02</b>  <b>ST400300S-06</b></p>	<p><b>463A PLUG to ALLIGATOR CLIPS</b></p>  <p><b>2' MAT # 1157465</b>  <b>6' MAT # 1157466</b></p>
<p><b>Protector to Protector "Frogger" with "In Line Protection", (20')</b></p> <ul style="list-style-type: none"> <li>• Frogger with In-Line Protection</li> <li>• Ideal for quick temporary restoral with "protection"</li> </ul>	<p><b>400300FP</b></p>	<p><b>"FROGGER" w/ IN-LINE PROTECTION</b></p>  <p><b>MAT # 1157486</b></p>
<p><b>Protector to (4) Alligator Clips, (8')</b></p> <ul style="list-style-type: none"> <li>• Access at (coils) both cable and equipment</li> </ul>	<p><b>400300S-4</b></p>	<p><b>PROTECTOR to (4) ALLIGATOR CLIPS</b></p>  <p><b>MAT # 1157485</b></p>
<p><b>526A plug to Alligator Clips, (2')</b></p> <ul style="list-style-type: none"> <li>• Monitor access to Protectors via test points without pulling Protector</li> <li>• Equivalent to P2FL</li> </ul>	<p><b>400526A-02</b></p>	<p><b>526A PLUG to ALLIGATOR CLIPS</b></p>  <p><b>MAT # 1157469</b></p>

FEATURES / APPLICATION	PART #	DESCRIPTION
<p><b>Dual Push Pins (310 MDF) to Alligator Clips, (3')</b></p> <ul style="list-style-type: none"> <li>Used to short the tip and ring or to ground the tip and/or ring</li> <li>Plugs to recessed terminals on 310 series connectors</li> <li>Equivalent to P2FM</li> </ul>	<p><b>400426</b></p>	<p><b>DUAL PUSH PINS to ALLIGATOR CLIPS</b></p>  <p><b>MAT # 1157484</b></p>
<p><b>453A plug to Alligator Clips, (3')</b></p> <ul style="list-style-type: none"> <li>Used to short the tip and ring or to ground the tip and/or ring</li> <li>Plugs to recessed terminals on 300 series connectors (except 310)</li> <li>Equivalent to P2EF</li> </ul>	<p><b>400430</b></p>	<p><b>453A PLUG to ALLIGATOR CLIPS</b></p>  <p><b>MAT # 1157481</b></p>
<p><b>Bantam to 800 DSX, (6')</b></p> <ul style="list-style-type: none"> <li>Test equipment access to 800 DSX</li> </ul>	<p><b>408210</b></p>	<p><b>BANTAM to 800 DSX</b></p>  <p><b>MAT # 1157181</b></p>
<p><b>310 to 800 DSX, (12')</b></p> <ul style="list-style-type: none"> <li>Test equipment access to 800 DSX</li> </ul>	<p><b>408310-12</b></p>	<p><b>310 to 800 DSX</b></p>  <p><b>MAT # 1183104</b></p>
<p><b>800 DSX Looping Plug</b></p> <ul style="list-style-type: none"> <li>Loops both directions</li> </ul>	<p><b>408800LD</b></p>	<p><b>800 DSX LOOPING PLUG</b></p>  <p><b>MAT # 1157470</b></p>
<p><b>800 DSX Terminating Plug</b></p> <ul style="list-style-type: none"> <li>Available in 100 ohm</li> </ul>	<p><b>408800TP-1</b></p>	<p><b>800 DSX TERMINATING PLUG</b></p>  <p><b>MAT # 1335085</b></p>

FEATURES / APPLICATION	PART #	DESCRIPTION
<p><b>Mueller Clip 25C to Mueller Clip 25C, (25')</b></p> <ul style="list-style-type: none"> <li>Retractable "coil" cord used with 188A test set</li> <li>Equivalent to W1BU-3</li> </ul>	<p><b>T-W1BU-3</b></p>	<p><b>MUELLER CLIP to MUELLER CLIP</b></p>  <p><b>MAT # 1157494</b></p>
<p><b>DB 9 Pin (male) to DB 9 Pin (female), (6')</b></p> <ul style="list-style-type: none"> <li>Commonly used from Laptop to test at HDSL circuits</li> <li>Wired straight</li> </ul>	<p><b>400720</b></p>	<p><b>9 PIN (male) to 9 PIN (female)</b></p>  <p><b>MAT # 1157473</b></p>
<p><b>15 Pin (female) to LIU connector, (8')</b>  <b>15 Pin (male) to LIU connector, (8')</b></p> <ul style="list-style-type: none"> <li>Connects Power Panel to LIU for test jack access</li> <li>Available in various lengths</li> </ul>	<p><b>400442F</b>  <b>400442M</b></p>	<p><b>15 PIN to LIU</b></p>  <p><b>400442F</b>  <b>400442M</b></p> <p><b>MAT # 1157180</b>  <b>MAT # 1157467</b></p>
<p><b>Protected Test Probe w/ LED</b></p> <ul style="list-style-type: none"> <li>Used for testing continuity</li> <li>Built in light for connection verification and fuse for protection</li> </ul>	<p><b>P-2000</b></p>	<p><b>PROTECTED TEST PROBE W/ LED</b></p>  <p><b>MAT # 1157493</b></p>
<p><b>Pin Plug to Alligator Clip, (6')</b></p> <ul style="list-style-type: none"> <li>Generally used for grounding</li> </ul>	<p><b>400409</b></p>	<p><b>PIN PLUG to ALLIGATOR CLIP</b></p>  <p><b>MAT # 1157476</b></p>

FEATURES / APPLICATION	PART #	DESCRIPTION
<p><b>440A to 440A - Red, (8')</b></p> <ul style="list-style-type: none"> <li>• Coax Patch/Test Cord</li> <li>• Available in various lengths</li> </ul>	<p><b>400440ARD</b></p>	<p><b>440A to 440A</b></p>  <p><b>MAT # 1157479</b></p>
<p><b>440A to 440A - Black, (8')</b></p> <ul style="list-style-type: none"> <li>• Coax Patch/Test Cord</li> <li>• Available in various lengths</li> </ul>	<p><b>400440ABK</b></p>	<p><b>440A to 440A</b></p>  <p><b>MAT # 1157477</b></p>
<p><b>440A to BNC - Red, (8')</b></p> <ul style="list-style-type: none"> <li>• Coax Patch/Test Cord</li> <li>• Available in various lengths</li> </ul>	<p><b>400440BRD</b></p>	<p><b>440A to BNC</b></p>  <p><b>MAT # 1157480</b></p>
<p><b>440A to BNC - Black, (8')</b></p> <ul style="list-style-type: none"> <li>• Coax Patch/Test Cord</li> <li>• Available in various lengths</li> </ul>	<p><b>400440BBK</b></p>	<p><b>440A to BNC</b></p>  <p><b>MAT # 1157478</b></p>



FEATURES / APPLICATION	PART #	DESCRIPTION
<p><b>Universal Carrying Case</b></p> <ul style="list-style-type: none"> <li>• Small Carrying Case</li> <li>• Approx. Dimensions: 5" (H) x 16" (L)</li> </ul>	<p><b>600209</b></p>	 <p><b>UNIVERSAL CARRYING CASE</b></p> <p><b>MAT # 1157463</b></p>
<p><b>Universal Carrying Case</b></p> <ul style="list-style-type: none"> <li>• Medium Carrying Case</li> <li>• Approx. Dimensions: 9" (H) x 16" (L)</li> </ul>	<p><b>600209N</b></p>	 <p><b>UNIVERSAL CARRYING CASE</b></p> <p><b>MAT # 1157177</b></p>
<p><b>8 Pouch Carrying Case</b></p> <ul style="list-style-type: none"> <li>• Test Cord Carrying Case</li> <li>• Approx. Dimensions: 12" (H) x 15" (L)</li> </ul>	<p><b>TCC-001P</b></p>	 <p><b>8 POUCH CARRYING CASE</b></p> <p><b>MAT # 1157462</b></p>
<p><b>Universal Carrying Case</b></p> <ul style="list-style-type: none"> <li>• Large Carrying Case</li> <li>• Approx. Dimensions: 13" (H) x 20" (L)</li> </ul>	<p><b>600209F</b></p>	 <p><b>UNIVERSAL CARRYING CASE</b></p> <p><b>MAT # 1157461</b></p>
<p><b>Universal Carrying Case</b></p> <ul style="list-style-type: none"> <li>• Extra Large Carrying Case</li> <li>• Approx. Dimensions: 16.25" (H) x 20" (L) x 7.5" (D)</li> </ul>	<p><b>600209XL</b></p>	 <p><b>UNIVERSAL CARRYING CASE</b></p> <p><b>MAT # 1157460</b></p>

## DB9M / RS232 to USB Adapter Cable

**Need access to a Serial Port on your Laptop?**

**TAG's Adapter Cable will convert your Laptop's USB Port into a Serial Port!**

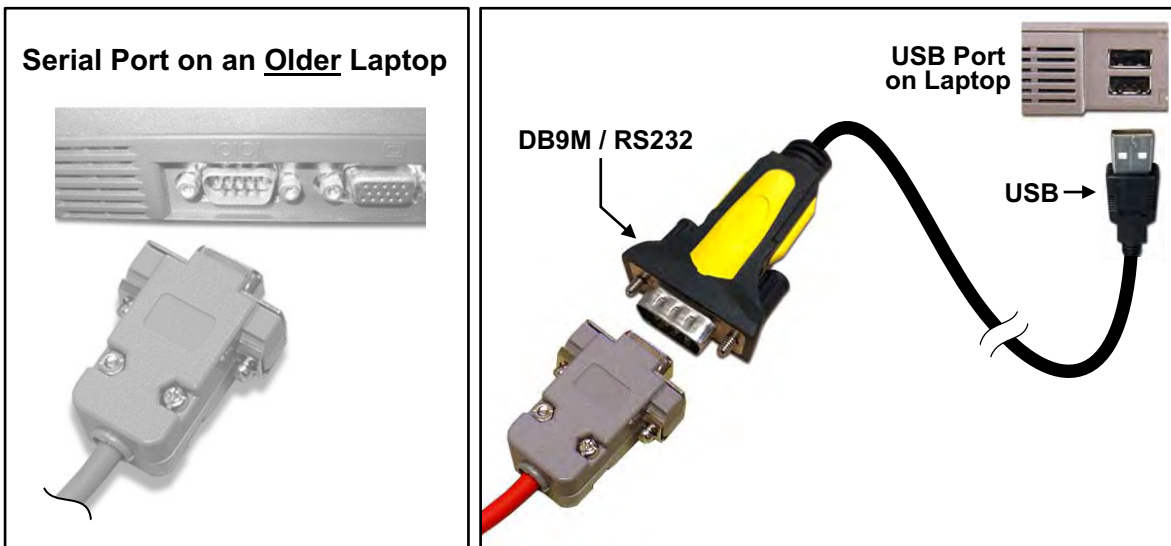

### System Requirements:

- Supports Windows® 2000 / XP / Server 2008 / Vista / 7 / 8 / 10 / 11
- Available USB Port

### Application:

Plug the USB connector into your computer and the serial connector into your serial device to exchange files, data and more.



### Ordering Information:

**400720USB DB9M/RS232 to USB Adapter Cable**  
*Supports Windows® 2000 / XP / Server 2008 / Vista / 7 / 8 / 10 / 11*

**Lumen/CLK MAT #**  
**1157436**

150 Cooper Rd. (F-15)  
 W. Berlin, NJ 08091

[www.tagcords.com](http://www.tagcords.com)

Telephone: (856) 753-8585  
 Fax : (856) 768-7645

**Telecom Assistance Group**

# Remote Network Cable Tester w/ Tone Generator

# CAT-107G

## Simplify Network Cable Testing !!

### Cable Test Features:

- Displays:**
- Short
  - Reversed
  - Miswired
  - Split Pairs

### Tone Generator\* Features:

- Verification of Shield Integrity
- Puts Tracer Tone on Cable

\* Tone Generator function requires customer supplied Cable Tracing Probe

### Additional Features:

- Specially designed Remote Unit that enables one person to test installed cables
- Easy to read Fault Display and high speed testing
- Debug mode for detailed fault identification results
- Auto Sleep Mode and Power Off Switch to decrease power consumption
- Low Battery Indicator
- Uses (4) four AAA batteries

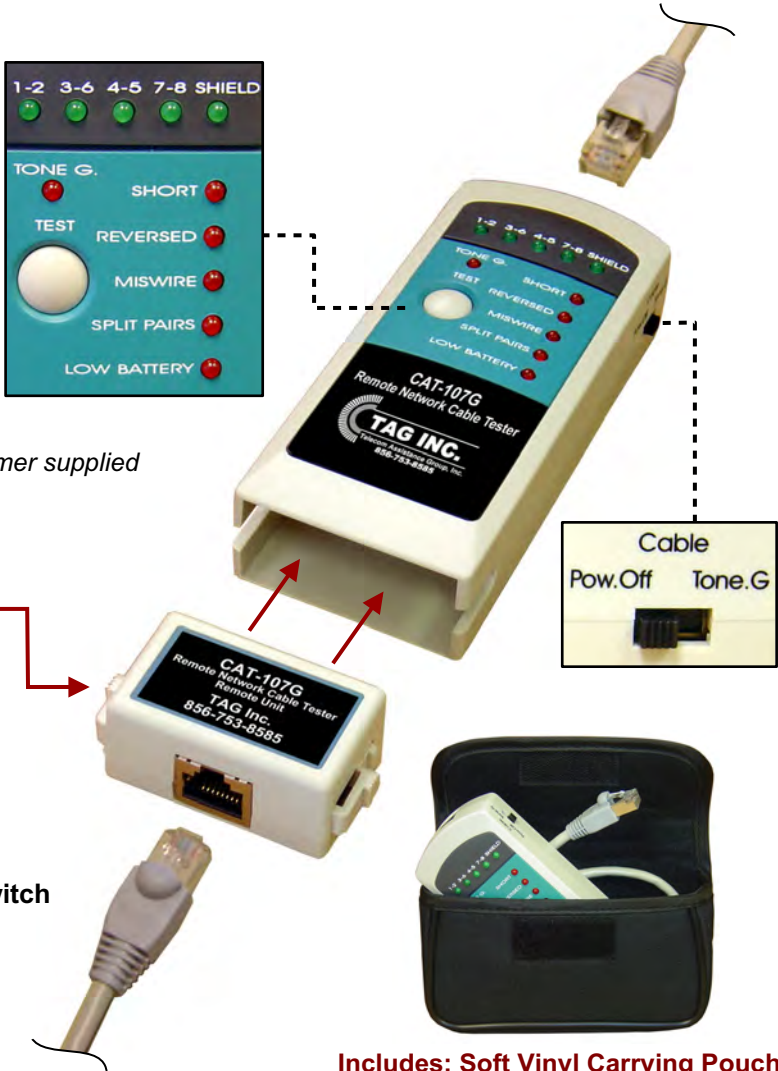

**Includes: Soft Vinyl Carrying Pouch & Remote Terminating Cable**

### Application:

The CAT-107G is a small hand-held cable tester, which enables network professionals to quickly and easily verify the integrity of ethernet twisted pair cables for open pairs, shorted pairs, reversed pairs, crossed pairs and split pairs. Push the TEST button and the CAT-107G will automatically scan for any existing faults in your cable. The specially designed remote terminator is provided for one-person testing of installed cables. The tone generator function can be used to send a signal through installed cables which can be traced with most cable tracers on the market.

<b>Ordering Information:</b>		<u>Lumen/CLK MAT #</u>
<b>CAT-107G</b>	<b>Remote Network Cable Tester w/ Tone Generator</b>	<b>1157497</b>
includes: (1) Carrying Pouch, (1) Remote Terminating Cable & (4) AAA Batteries		

150 Cooper Rd. (F-15)  
W. Berlin, NJ 08091

[www.tagcords.com](http://www.tagcords.com)

Telephone: (856) 753-8585  
Fax : (856) 768-7645

**Telecom Assistance Group**

# Wire Reel Brake Replacement

# WR-102BRK

## **PUT THE BRAKES ON!!!**

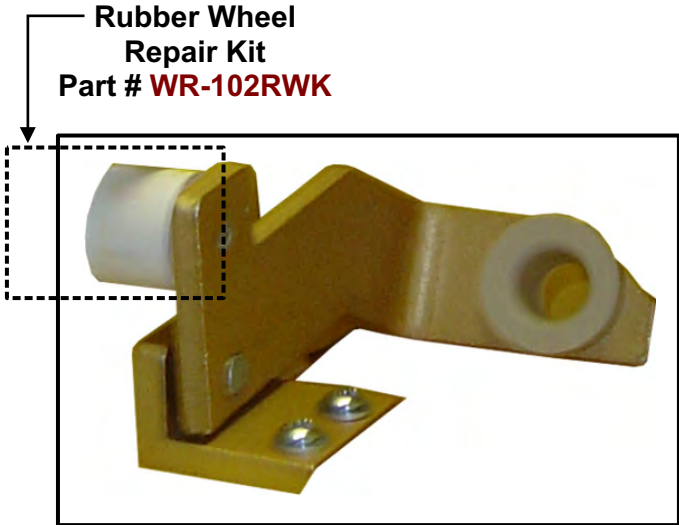

Rubber Wheel  
Repair Kit  
Part # **WR-102RWK**

Wire Reel Brake  
Replacement  
Part # **WR-102BRK**

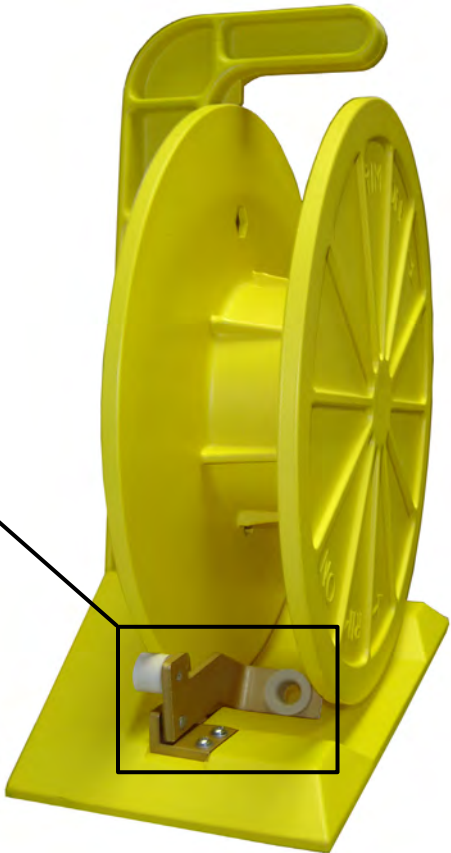

▶ *Avoid cross connect wire spool tangles and wasting of wire.*

▶ *The WR-102BRK replaces broken and/or worn-out brakes.*

**New Brake Assemblies for Central Office Wire Reels**  
*(wire reel is not included)*

<b>Ordering Information:</b>		<u>Lumen/CLK MAT #</u>
<b>WR-102BRK</b>	<b>Cable Reel Brake Assembly w/ Grommet &amp; Brake</b>	<b>1157502</b>
<b>WR-102RWK</b>	<b>Rubber Wheel Repair Kit</b> includes (4) Rubber Wheels & (4) Retaining Spring Clips	<b>1157450</b>

150 Cooper Rd. (F-15)  
W. Berlin, NJ 08091

[www.tagcords.com](http://www.tagcords.com)

Telephone: (856) 753-8585  
Fax : (856) 768-7645

**Telecom Assistance Group**

**DLC Cord Kit**

**DLC-KITQWT**



**(1) # TCC-001P - MAT # 1157462**  
Carrying Case

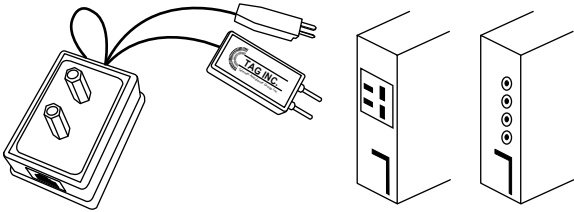

**(1) # 4003956 - MAT # 1157496**  
"The Slick Cord" - Series 5 & SLC 96



**(2) # ST400210A-06 - MAT # 1157472**  
Bantam to (2) Alligator Clips, (6')



**(1) # 400703-25**  
DB 9 Pin (female) to DB 25 Pin (male), (25')



**(2) # 408210**  
Bantam to 800 DSX, (6')



**(1) # 400722ADSL**  
Catena DB 9 Pin (female) to RJ45, (6')



**(2) # 400210WP**  
Bantam to Wire Wrap Terminals, (6')



**(1) # 400720**  
DB 9 Pin (male) to DB 9 Pin (female), (6')

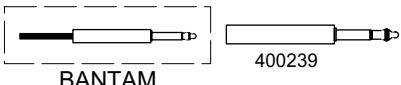

**(2) # 400239 - MAT # 1157438**  
Bantam to 310 Conversion Plug



**(1) # 400703H-25**  
DB 9 Pin (male) to DB 25 Pin (male), (25')



**(1) # 400440BLP**  
BNC Loopback Cord, (9')

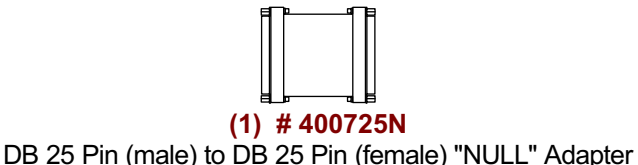

**(1) # 400725N**  
DB 25 Pin (male) to DB 25 Pin (female) "NULL" Adapter



**(1) # 400210BK - MAT # 1157483**  
Bantam to Bantam, RX - Black, (6')



**(1) # 400448XP-10**  
DMX Provisioning (CAT5E) Cross-Over Cable, (10')



**(1) # 400210RD - MAT # 1157482**  
Bantam to Bantam, TX - Red, (6')



**(1) # 400448-06**  
RJ48 to RJ48, (6')

**Ordering Information:**

**DLC-KITQWT**

**DLC Cord Kit**

includes: (2) ST400210A-06, (1) 400210BK, (1) 400210RD, (2) 408210, (1) 400720, (2) 400210WP, (2) 400239, (1) 4003956, (1) 400725N, (1) 400703-25, (1) 400448XP-10, (1) 400440BLP, (1) 400703H-25, (1) 400722ADSL, (1) 400448-06 & (1) TCC-001P

**Lumen/CLK MAT #  
1157495**

150 Cooper Rd. (F-15)  
W. Berlin, NJ 08091

[www.tagcords.com](http://www.tagcords.com)

Telephone: (856) 753-8585  
Fax : (856) 768-7645

**Telecom Assistance Group**

# JDSU HST-3000\* Cord Kit

# KIT-HST3000H4



8 Pouch Carrying Case  
Part # TCC-001P

## Test Cord Kit for use with JDSU HST-3000\*

-Individual items can also be ordered-

Provides a carrying case with all the  
cords that a "Tech" needs in the field

HST3000 to 463A Protector (Red), (6')  
Part # ACT-400100SRD



HST3000 to 463A Protector (Blue), (6')  
Part # ACT-400100SBY



HST3000 to Mini Test Clips (Red), (6')  
Part # ACT-400100TRD

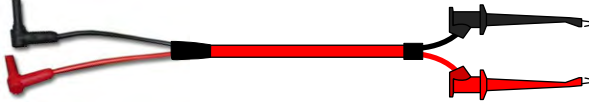

HST3000 to Mini Test Clips (Blue), (6')  
Part # ACT-400100TBY



HST3000 to Bantam (Red), (6')  
Part # ACT-400100BRD



HST3000 to Bantam (Blue), (6')  
Part # ACT-400100BBY



HST3000 to RJ48C - (T1), (6')  
(RJ48 Pins 1,2,4,5)  
Part # ACT-400148BY

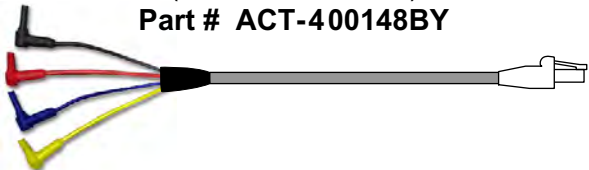

HST3000 to RJ48S - (DDS), (6')  
(RJ48 Pins 1,2,7,8)  
Part # ACT-400148SBY

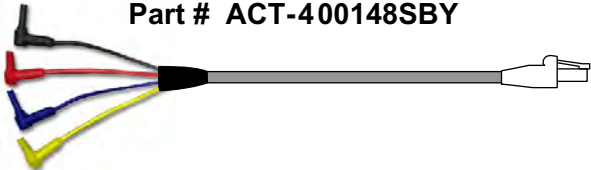

### Ordering Information:

**KIT-HST3000H4**

**HST-3000\* Cord Kit**

includes: (1) ACT-400100SRD, (1) ACT-400100SBY,  
(1) ACT-400100TRD, (1) ACT-400100TBY,  
(1) ACT-400100BRD, (1) ACT-400100BBY,  
(1) ACT-400148SBY, (1) ACT-400148BY & (1) TCC-001P

**Lumen/CLK MAT #  
1157475**

150 Cooper Rd. (F-15)  
W. Berlin, NJ 08091

Telephone: (856) 753-8585  
Fax : (856) 768-7645

[www.tagcords.com](http://www.tagcords.com)

## Telecom Assistance Group

# xDSL Test Cord

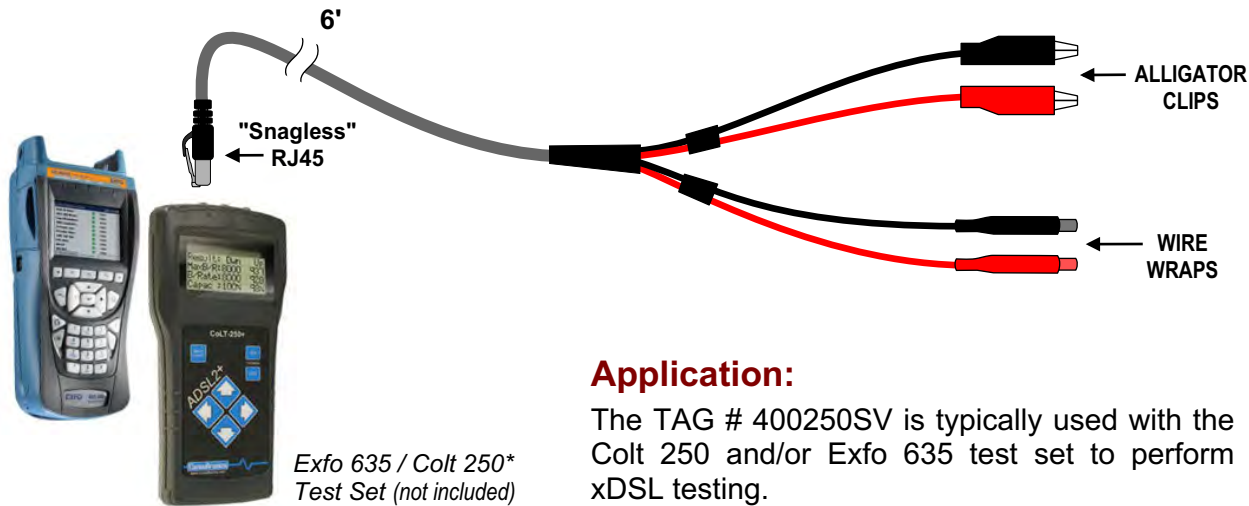

### Application:

The TAG # 400250SV is typically used with the Colt 250 and/or Exfo 635 test set to perform xDSL testing.

<b>Ordering Information:</b>		<u>Lumen/CLK MAT #</u>
400250SV	RJ45 (snagless) to Alligator Clips / Wire Wraps, (6')	1341497

# Bonded ADSL2+ / VDSL2 Test Cord

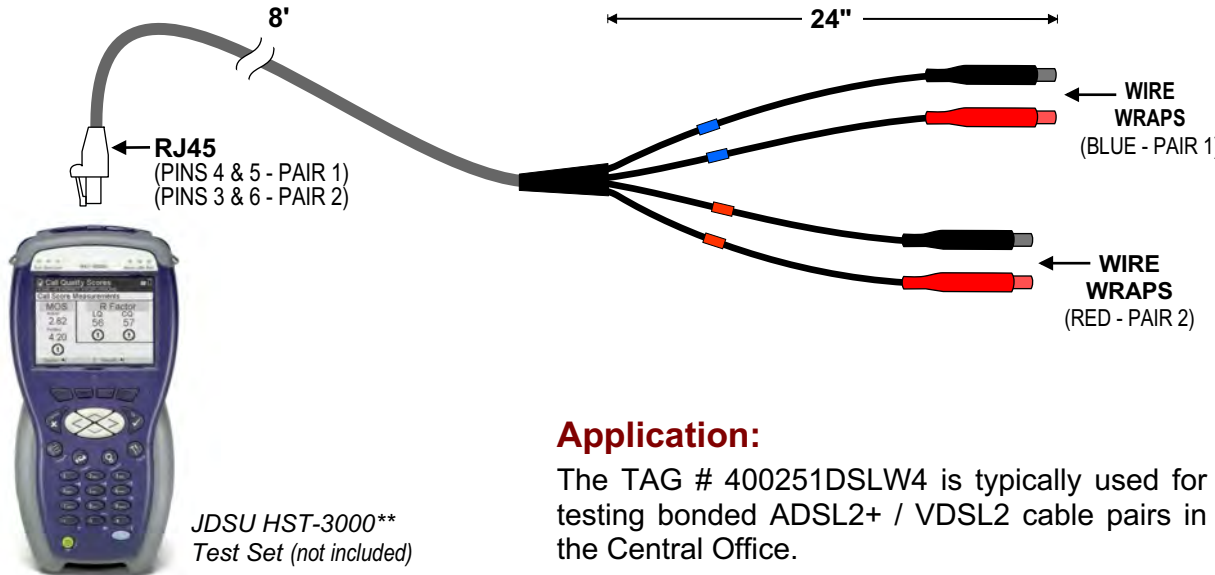

### Application:

The TAG # 400251DSLW4 is typically used for testing bonded ADSL2+ / VDSL2 cable pairs in the Central Office.

<b>Ordering Information:</b>		<u>Lumen/CLK MAT #</u>
400251DSLW4	RJ45 to (4) (2 Blue / 2 Red) Wire Wraps, (8')	1339897

150 Cooper Rd. (F-15)  
W. Berlin, NJ 08091

www.tagcords.com

Telephone: (856) 753-8585  
Fax : (856) 768-7645

## Telecom Assistance Group

# MLT Load / Test Box

# 400301MLT



TAG's MLT Load/Test Box (400301MLT) provides a convenient and easy means to **Test** with **MLT** on **New Installs** and **Calibrate "Loop Resistance"**.

Simply plug the MLT Load/Test Box on the circuit to test with MLT. Establish communication with a MLT tester to verify results.

Note: TAG offers a "Hands Free" Telephone Set - Model WT-1K for added convenience. A sturdy switch on the MLT Load/Test Box allows selecting the following tests:

- Tip to Ring Short
- Ring to Ground (10K)
- Tip to Ring Load (10K)
- Ringer Test Load (>.75A)
- Tip to Ground (10K)
- Thru to Hollow Posts and RJ11 (just in case)

The MLT Load/Test Box plugs to various interface points for ease of testing with MLT. The 400301MLT can be equipped with "coil access" at the RT, RJ11 access at the NID or Alligator Clips for general purpose.

## Ordering Information:

400301MLT

Cord Protector MLT Test Box, (6')

## Lumen/CLK MAT #

1157498

150 Cooper Rd. (F-15)  
W. Berlin, NJ 08091

[www.tagcords.com](http://www.tagcords.com)

Telephone: (856) 753-8585  
Fax : (856) 768-7645

## Telecom Assistance Group



## Apparatus Cases (T1, HDSL, DDS)

### EXT-209

T1 Loopback Extender  
(w/ Bantam Jacks)

#### Application:

- Universal interface to all test sets
- Loops signal and simplex current
- Isolates trouble to repeater or cable
- Bantam Jack access eliminates special probes and cables
- Direct metallic bridging allows current, voltage and loop resistance measurements



Lumen/CLK MAT #

1157489

### EXT-209T

T1 Repeater Extender  
(w/ Bantam Jacks)

#### Application:

- Span current test points
- Loops signal and simplex current
- Test repeaters in the field
- Bantam Jack access to monitor/transmit QRSS, 3 in 24 from test sets
- Direct metallic bridging allows current, voltage and loop resistance measurements



Lumen/CLK MAT #

1157488

### EXT-238

T1 Line Repeater Wiring  
Access Board  
(w/ Bantam Jacks)

Lumen/CLK MAT #

1157499



#### Application:

The EXT-238 plugs into T1, 56KB, HDSL, and ISDN apparatus cases for easy access to wiring via "bantam jacks." Plug the EXT-238 into mini T1 line repeater slots to verify wiring and perform cable loss test (T1 acceptance test).

150 Cooper Rd. (F-15)  
W. Berlin, NJ 08091

[www.tagcords.com](http://www.tagcords.com)

Telephone: (856) 753-8585  
Fax : (856) 768-7645

**Telecom Assistance Group**

# T1 Repeater Test Kit

# EXT-238K3

The EXT-238K3 Kit is designed for technicians who test at T1 Line Repeater Housings, such as 818 apparatus cases. (see Fig. 1) The Kit Includes:



Fig. 1

**Lumen/CLK MAT #**  
**1157439 (Kit)**

**(1) # EXT-238**  
**T1 Line Repeater Access Board**

**Lumen/CLK MAT #**  
**1157499**  
(test board only)

**(1) # 600209**  
**Carrying Case**

**Lumen/CLK MAT #**  
**1157463**  
(carrying case only)



**(1) # 400210RD-03**  
**Bantam to Bantam - Red, (3')**



**(1) # 400210ARD-03**  
**Bantam to Alligator Clips - Red, (3')**



**(1) # 400210BK-03**  
**Bantam to Bantam - Black, (3')**



**(1) # 400210ABK-03**  
**Bantam to Alligator Clips - Black, (3')**

**Ordering Information:**

<b>EXT-238K3</b>	<b>T1 Repeater Access Kit</b>	<b>Lumen/CLK MAT #</b>
	includes: (1) EXT-238, (1) 400210RD-03, (1) 400210BK-03,	<b>1157439</b>
	(1) 400210ARD-03, (1) 400210ABK-03 & (1) 600209	

150 Cooper Rd. (F-15)  
W. Berlin, NJ 08091

[www.tagcords.com](http://www.tagcords.com)

Telephone: (856) 753-8585  
Fax : (856) 768-7645

## Telecom Assistance Group

# T1 Repeater Wiring Access Board

# EXT-239E

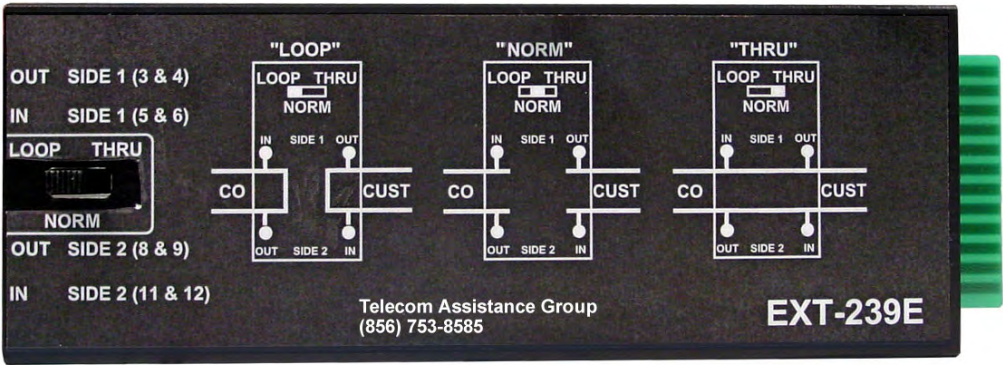

### EXT-239E

Plugs into T1, 56KB, HDSL, ISDN Apparatus Cases

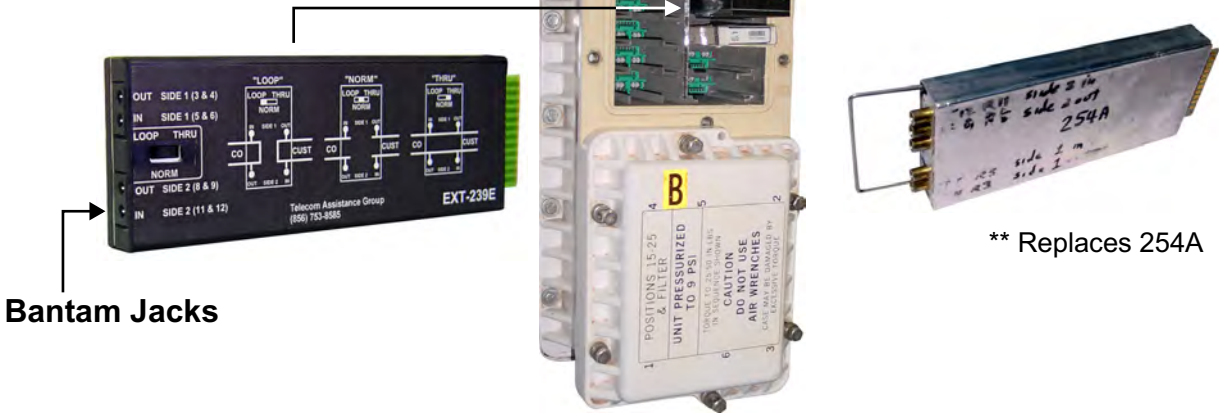

Bantam Jacks

### Features:

- Enhanced switch settings for Thru, Norm, and Loop testing at T1 line repeater apparatus cases.
- Metallic access at T1 line repeater slots.
- Use with test sets to perform Cable Loss, Resistance, or TDR test set to locate load coils.

### Ordering Information:

<b>EXT-239E</b>	<b>T1 Repeater Wiring Access Board w/ Bantam Jacks</b>	<b><u>Lumen/CLK MAT #</u></b>
		<b>1157440</b>

150 Cooper Rd. (F-15)  
W. Berlin, NJ 08091

[www.tagcords.com](http://www.tagcords.com)

Telephone: (856) 753-8585  
Fax : (856) 768-7645

## Telecom Assistance Group

# Adtran

## "Total Access 3000"



**ST-TA3000CU**  
 Adtran **Total Access 3000**  
 CU Streaker Card  
 w/ LEDs

**Application:**  
 The ST-TA3000CU provides both continuity testing and jack access for signal acceptance testing from the Adtran Total Access 3000 CU card slot to the cross-connect wiring points.

**Lumen/CLK MAT #**  
**1157451**

**TB-TA3000CU**  
 Adtran **Total Access 3000** Test Board  
 w/ Bantam Jacks

**Application:**  
 The TB-TA3000CU plugs in the Adtran Total Access 3000 card slots and has Bantam jacks that allow access to the cabling from the card slot to the cross-connect wiring points. Using a T1 Test Set, the tester can transmit and receive T1 signals to verify cable acceptance and continuity.



**Lumen/CLK MAT #**  
**1157444**

<b>Accessories:</b>		<b><u>Lumen/CLK MAT #</u></b>
<b>P-2000</b>	<b>Protected Test Probe w/ LED</b>	<b>1157493</b>
<b>600209N</b>	<b>Carrying Case</b>	<b>1157177</b>

150 Cooper Rd. (F-15)  
 W. Berlin, NJ 08091

[www.tagcords.com](http://www.tagcords.com)

Telephone: (856) 753-8585  
 Fax : (856) 768-7645

### Telecom Assistance Group

# Office Repeater / Wiring Access Boards

**TB-86B**  
**"DDM Plus"**  
 Office Repeater Test Board  
 (w/ Bantam Jacks)

**Lumen/CLK MAT #**  
**1157445**



**TB-231B**  
**"220"**  
 Office Repeater Test Board  
 (w/ Bantam Jacks)

**Lumen/CLK MAT #**  
**1157441**

**TB-3192B**  
**"3190 / 3192"**  
 Office Repeater Test Board  
 (w/ Bantam Jacks)

**Lumen/CLK MAT #**  
**1157442**

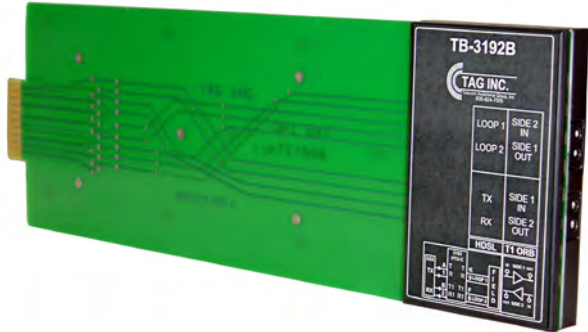

**TB-400B**  
**"HDSL - HRU"**  
 Wiring Access Board  
 (w/ Bantam Jacks)

**Lumen/CLK MAT #**  
**1157443**



150 Cooper Rd. (F-15)  
 W. Berlin, NJ 08091

[www.tagcords.com](http://www.tagcords.com)

Telephone: (856) 753-8585  
 Fax : (856) 768-7645

**Telecom Assistance Group**

# Adtran



## "Total Access 5000"

**ST-T5K-SHDSL**  
Adtran TA5000  
SHDSL Streaker Card

32 Port (w/ 64 LEDs)

**Lumen/CLK MAT #**  
**1108511**

**ST-T5K-SPLTRV**  
Adtran TA5000  
V2 Splitter Streaker Card

32 Port (w/ 128 LEDs)

**Lumen/CLK MAT #**  
**1157455**



**ST-T5K-DS1**  
Adtran TA5000  
DS1 Streaker Card

(Can be used for both 32 port DS1 &  
32 port DS1 Voice Gateway)  
(w/ 128 LEDs)

**Lumen/CLK MAT #**  
**1157459**

150 Cooper Rd. (F-15)  
W. Berlin, NJ 08091

[www.tagcords.com](http://www.tagcords.com)

Telephone: (856) 753-8585  
Fax : (856) 768-7645

# Telecom Assistance Group

# Adtran

## "Total Access 5000"

**ST-T5K-COMBO**  
**Adtran TA5000**  
**Combo Streaker Card**

24 Port (w/ 48 LEDs)

Lumen/CLK MAT #  
**1121914**



**ST-T5K-8HT1**  
**Adtran TA5000**  
**8 Port HDSL/T1 Streaker Card**

8 Port (w/ 32 LEDs)

Lumen/CLK MAT #  
**1157456**



150 Cooper Rd. (F-15)  
W. Berlin, NJ 08091

[www.tagcords.com](http://www.tagcords.com)

Telephone: (856) 753-8585  
Fax : (856) 768-7645

### Telecom Assistance Group

**ArcaDacs Streaker Kit**

**CT-50ARCKIT**



**(1) # CT-50ARC**

50 Pin Amphenol Cable Streaker Unit



**BX-50\***

50 Pin Breakout Box  
\*sold separately



**(1) # P-2000**

Protected Test Probe w/ LED



**(1) # 400409**

Ground Cord, (6')



**(1) # 300187-16**

50 Pin Amphenol Cable  
(Specialty Extension Cable - (8'))



**(1) # 600209N**

Carrying Case

**Ordering Information:**

		<u>Lumen/CLK MAT #</u>
<b>CT-50ARCKIT</b>	<b>50 Pin Amphenol Cable Streaker Unit Test Kit</b> includes: (1) CT-50ARC, (1) 300187-16, (1) 400409, (1) P-2000 & (1) 600209N	<b>1108178</b>
<b>CT-50ARC</b>	<b>50 Pin Amphenol Cable Streaker Unit</b>	<b>1106075</b>
<b>400409</b>	<b>Continuity Ground Cord, (6')</b>	<b>1157476</b>
<b>P-2000</b>	<b>Protected Test Probe w/LED</b>	<b>1157493</b>
<b>600209N</b>	<b>Carrying Case</b>	<b>1157117</b>
<hr/>		
<b>BX-50</b>	<b>Wiring Access 50 Pin (Amphenol) Breakout Box</b>	<b>1157448</b>
	**not included in kit - please order separately**	

150 Cooper Rd. (F-15)  
W. Berlin, NJ 08091

[www.tagcords.com](http://www.tagcords.com)

Telephone: (856) 753-8585  
Fax : (856) 768-7645

**Telecom Assistance Group**



# Calix E7-2 Streaker Kit

# E7-2-KIT-01

## "Calix E7-2"



**(1) # ST-CALIX-E7-2**  
Calix E7-2 Streaker Card, 48 Port w/ 96 LEDs

**Application:**

The ST-CALIX-E7-2 provides a quick method to "streak", verify wiring via LEDs, from the backplane of the Calix E7-2 to the Frame. At the Frame simply ground the corresponding pins and the ST-CALIX-E7-2 will light the LED associated with that connection.



Approx. Dimensions:  
16" (H) x 20" (L)



**(1) # P-2000**  
Protected (-48V) Test Probe w/ LED, (6')



**(1) # 400409**  
Pin Plug to Alligator, (6')



**(1) # 600209XL**  
Carrying Case

**Ordering Information:**

		<u>Lumen/CLK MAT #</u>
<b>E7-2-KIT-01</b>	<b>Calix E7-2 Streaker Kit</b> includes: (1) ST-CALIX-E7-2, (1) 400409, (1) P-2000 & (1) 600209XL - carrying case	<b>1250641</b>
<b>P-2000</b>	<b>Protected Test Probe w/ LED</b>	<b>1157493</b>
<b>600209XL</b>	<b>Carrying Case</b>	<b>1157460</b>

150 Cooper Rd. (F-15)  
W. Berlin, NJ 08091

[www.tagcords.com](http://www.tagcords.com)

Telephone: (856) 753-8585  
Fax : (856) 768-7645

# Telecom Assistance Group

**Portable "C" HDSL Powering / Test Unit Kit**

**PHTUC-QWE01**

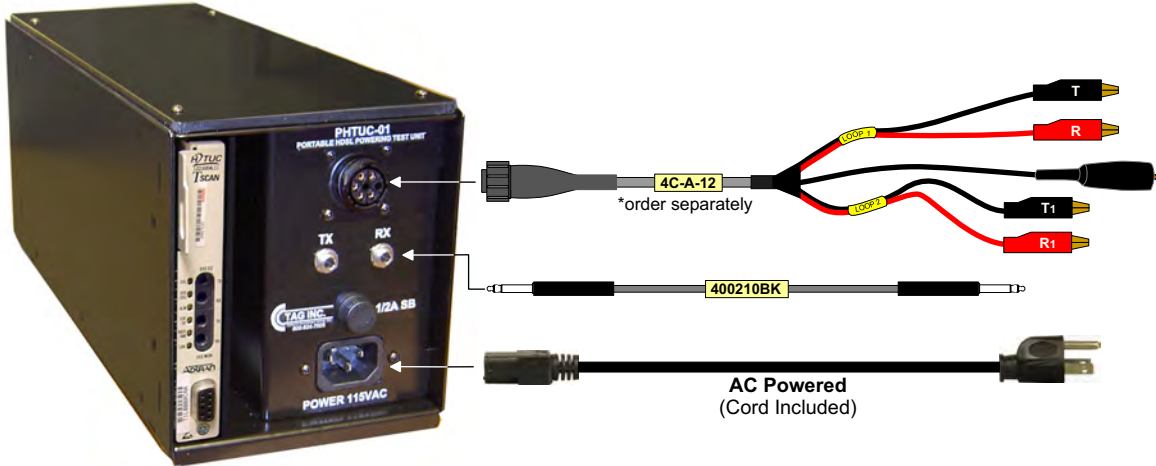

(card not included)

- ▶ **Portable Powering / Test Unit**
- ▶ **Isolates Troubles**
- ▶ **New Installs**
- ▶ **Bantam Jacks for T1 Test Sets**
- ▶ **1 Slot (2 & 4 Wire)**
- ▶ **3192 Mech.**

**HDSL Application Diagram**

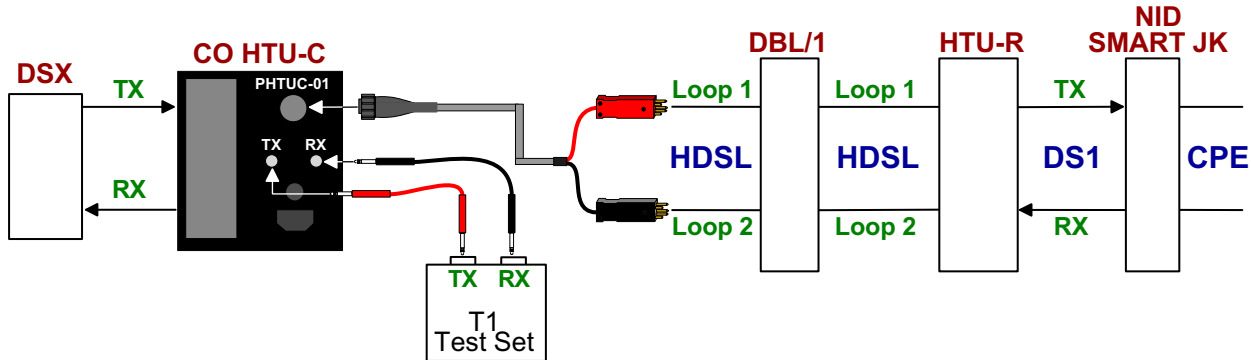

**Ordering Information:**

**PHTUC-QWE01 Portable "C" HDSL Powering / Test Unit Kit**

Includes: (1) PHTUC-01, (1) 400210RD, (1) 400210BK, (1) 4C-463LY-12, (1) 4C-412LY-12, (1) 4C-PORTLY-12 & (1) 600510 - Carrying Case

**Lumen/CLK MAT #**  
**1201288**

4C-A-12	Male Lock Plug to (4) Std Alligator Clips w/ GND, (12')	1230934
4C-6P-12	Male Lock Plug to (4) 6P Alligator Clips w/ GND, (12')	1230936
4C-412LY-12	Male Lock Plug to 412 Long "Y", (12')	1230933
4C-463LY-12	Male Lock Plug to 463 Long "Y", (12')	1230932
400210BK	Bantam to Bantam Test Set Cord - Black, (6')	1157483
400210RD	Bantam to Bantam Test Set Cord - Red, (6')	1157482

150 Cooper Rd. (F-15)  
W. Berlin, NJ 08091

[www.tagcords.com](http://www.tagcords.com)

Telephone: (856) 753-8585  
Fax : (856) 768-7645

**Telecom Assistance Group**

# T-Berd\* 209 OSP Test Set Kits & Battery Replacements

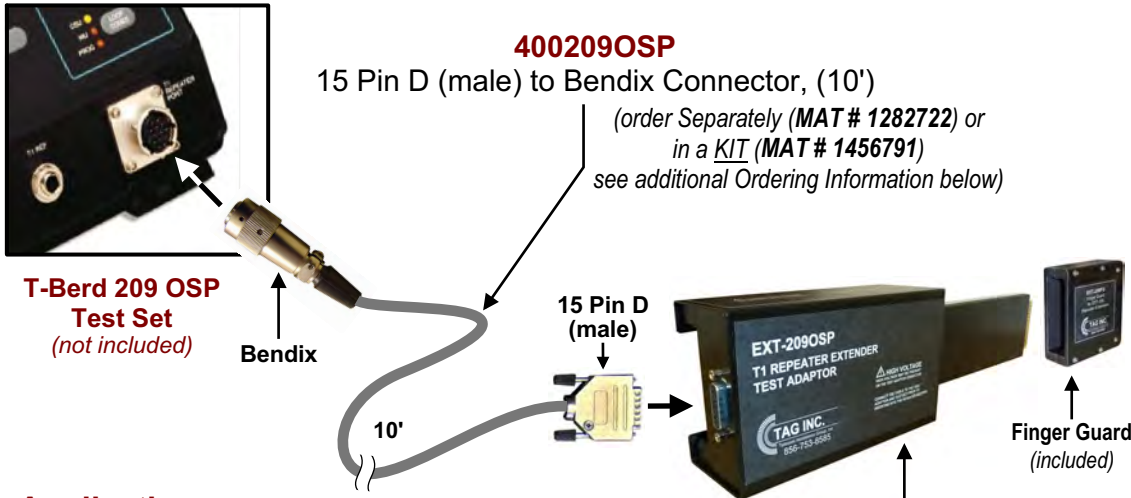

**T-Berd 209 OSP Test Set**  
(not included)

Bendix

**400209OSP**

15 Pin D (male) to Bendix Connector, (10')

(order Separately (MAT # 1282722) or in a KIT (MAT # 1456791) see additional Ordering Information below)

15 Pin D (male)



Finger Guard (included)

**EXT-209OSP**

T-Berd 209 OSP "Smart" Repeater Adapter w/ 15 Pin D Connector

(order Separately (call for pricing) or in a KIT (MAT # 1456791) see additional Ordering Information below)

**Application:**

TAG's # 400209OSP is the auto-test replacement cable for the T-Berd 209 OSP. The # 400209OSP connects from the Bendix connector on the T-Berd 209 OSP Test Set to the 15 pin connector on the "smart" repeater adapter (TTC 41754 or TAG's # EXT-209OSP).

**BR-209OSP**  
Battery Replacement for T-Berd 209  
(order Separately (MAT # 1250307))



**T-Berd 209 OSP Test Set**  
(not included)



- ▶ 12V DC / 2.8 Ah
- ▶ Drop-in Replacement
- ▶ 3yr Warranty

**Ordering Information:**

**Lumen/CLK MAT #**

**KIT-209OSP**

**T-Berd 209 OSP Auto Test T1 Repeater Test Kit**

includes: (1) EXT-209OSP, T-Berd 209 OSP "Smart" Repeater Adapter w/ 15 Pin D Connector (includes Finger Guard # EXT-209FG)  
(1) 400209OSP, 15 Pin D (male) to Bendix Connector, (10') &  
(1) 600209N - 9" (H) x 16" (L) Carrying Case

**1456791**

**400209OSP**

**15 Pin D (male) to Bendix Connector, (10')**

**1282722**

**BR-209OSP**

**Battery Replacement for T-Berd 209**

**1250307**

150 Cooper Rd. (F-15)  
W. Berlin, NJ 08091

www.tagcords.com

**Telecom Assistance Group**

Telephone: (856) 753-8585

Fax : (856) 768-7645

**Lumen / CenturyLink Approved - NEBS Certified - 5ESS Solid State Drive Solutions from TAG**

**5ESS SWITCH w/ EXISTING DRIVES**  
(w/ "MOVING PARTS")

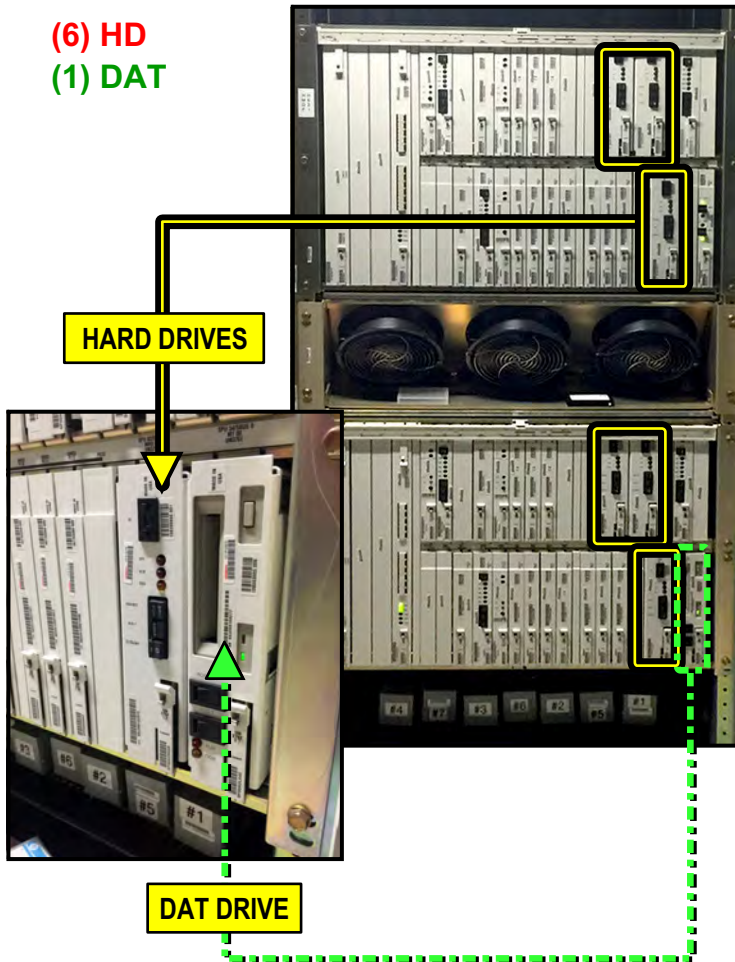

**NEW SOLID STATE DRIVES FROM TAG**

**NEW HARD DRIVE**  
(installed on UN375E/F circuit pack)



**NEW DAT DRIVE w/ COMPACT FLASH**  
(installed on UN376E/F circuit pack)

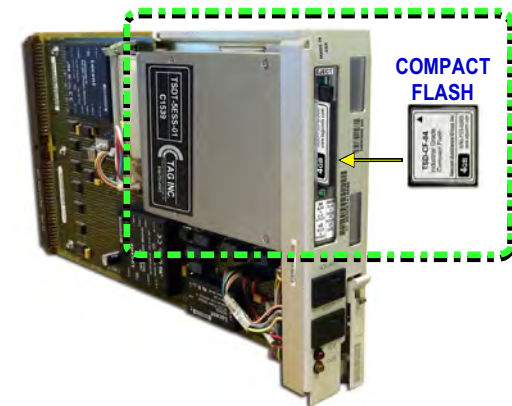

**Application:**

TAG can **REPLACE** failing / broken 5ESS Hard Drives & DAT Drives with **NEW** Solid State SCSI Drives.

TAG MODEL #	USED ON UN375E AND UN375F CIRCUIT PACKS (HD)	
TSD-5ESS-01	Solid State Replacement for: <b>Hard Drive</b> , HECI code SP3QADRAAA (typical), KS-23908 QUANTUM 3.5 INCH SCSI	9.1 Gb
<b>Lumen/CLK MAT #</b> <b>R1354898</b>		

TAG MODEL #	USED ON UN376E AND UN376F CIRCUIT PACKS (DAT)	
TSDT-5ESS-01	Solid State Replacement for: <b>DAT Drive</b> , C1539, HECI code SP3QADLAAC (typical), <i>Includes: 4Gb Industrial Compact Flash Card (# TSD-CF-04*)</i>	4 Gb
<b>Lumen/CLK MAT #</b> <b>R1355139</b>		

\* Additional Compact Flash Cards are Available:  
4Gb (# TSD-CF-04, MAT # R1343960), 8Gb (# TSD-CF-08), 16Gb (# TSD-CF-16), 32Gb (# TSD-CF-32)

150 Cooper Rd. (F-15)  
W. Berlin, NJ 08091

www.tagcords.com  
**Telecom Assistance Group**

Telephone: (856) 753-8585  
Fax : (856) 768-7645

**Lumen / CenturyLink Approved - NEBS Certified - Ericsson AXE-10 IOG11 Drive Solutions from TAG**

**ERICSSON AXE-10 IOG11 MODULES  
w/ EXISTING HARD DRIVE & OPTICAL DISK DRIVE  
(w/ "MOVING PARTS")**



**AXE-10 IOG11 MODULES  
w/ NEW SOLID STATE DRIVES FROM TAG**

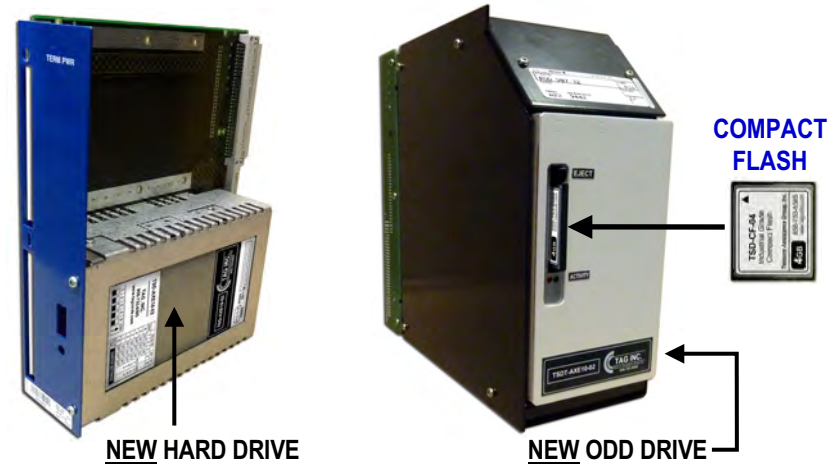

**Application:**

TAG can **REPLACE** failing / broken Hard Drives and Optical Disk Drives within Ericsson AXE-10 IOG11 Modules with **NEW** Solid State Drives.

**NEW SOLID STATE DRIVES AVAILABLE FROM TAG**

TAG MODEL #	USED IN AXE-10 IOG11 HARD DRIVE MODULE (HECI DNPQAL9AAA)	
TSD-AXE10-02	Solid State Replacement for: <b>Ericsson AXE-10 IOG11</b> Module # ROF 137 7942/8 R1A HD-B 2GB (HECI DNPQAL9AAA) Hard Drive	2 Gb
<b>Lumen/CLK MAT # R1343948</b>		
TAG MODEL #	USED IN AXE-10 IOG11 ODD MODULE (HECI DNMYABKEAA)	
TSDT-AXE10-02	Solid State Replacement for: <b>Ericsson AXE-10 IOG11</b> Module # ROD 907 32 (HECI DNMYABKEAA) Optical Disk Drive <i>Includes: 4Gb Industrial Compact Flash Card (# TSD-CF-04*)</i>	4 Gb
<b>Lumen/CLK MAT # R1343949</b>		
* Additional Compact Flash Cards are Available: 4Gb (# TSD-CF-04, MAT # R1343960), 8Gb (# TSD-CF-08), 16Gb (# TSD-CF-16), 32Gb (# TSD-CF-32)		

150 Cooper Rd. (F-15)  
W. Berlin, NJ 08091

www.tagcords.com  
**Telecom Assistance Group**

Telephone: (856) 753-8585  
Fax : (856) 768-7645

**Lumen / CenturyLink Approved - NEBS Certified - Siemens EWSD Drive Solutions from TAG**

**SIEMENS EWSD w/ EXISTING DRIVES  
MAGNETO-OPTICAL (MO) & HARD DISK (HDD)  
(w/ "MOVING PARTS")**

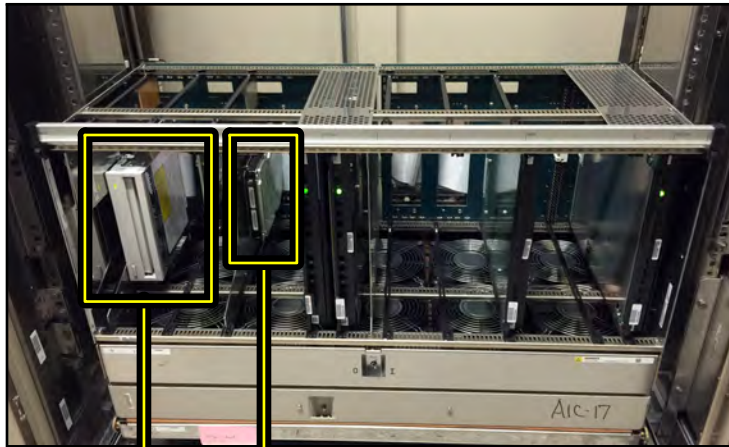

**HARD DISK (HDD)**

**MAGNETO-OPTICAL (MO)**

**Application:**

TAG can **REPLACE** failing / broken Siemens EWSD Magneto-Optical (MO) & Hard Disk (HDD) Drives with **NEW** Solid State Drives.

**NEW SOLID STATE DRIVES FROM TAG**

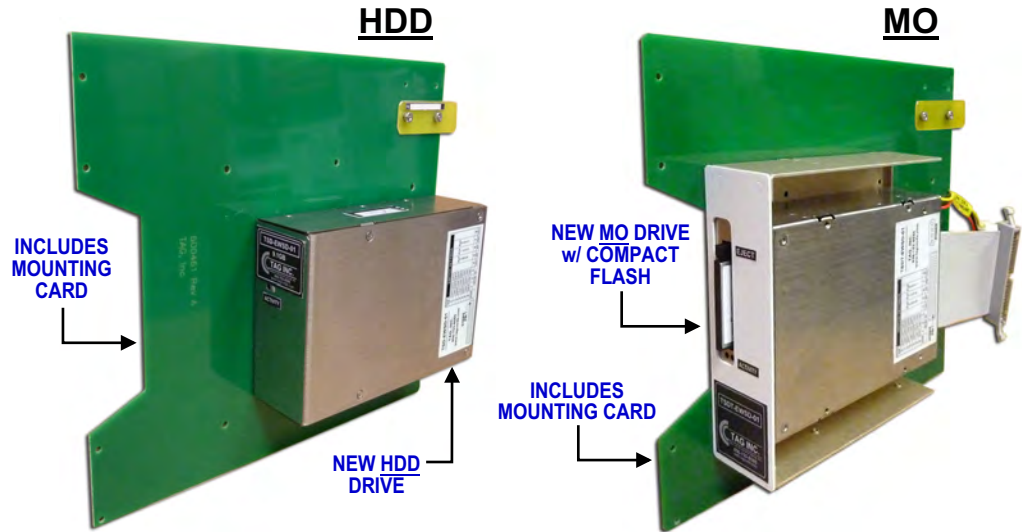

**NEW SOLID STATE DRIVES AVAILABLE FROM TAG**

TAG MODEL #	USED IN SIEMENS EWSD HDD MODULE (HECI EQMYAE0DAA)	
<b>TSD-EWSD-01</b> <b>Lumen/CLK MAT # R1344482</b>	Solid State Replacement for: <b>Siemens EWSD</b> Module # S30807-U2594-X300 (HECI EQMYAE0DAA) <b>Hard Disk Drive (HDD) w/ Mounting</b> (S30122-U789-X-2 (ST-39173N))	9.1Gb
TAG MODEL #	USED IN SIEMENS EWSD MO DRIVE MODULE (HECI EGM8JF0BRA)	
<b>TSDT-EWSD-01</b> <b>Lumen/CLK MAT # R1344483</b>	Solid State Replacement for: <b>Siemens EWSD</b> Module # S30807-U2593-X200 (HECI EGM8JF0BRA) <b>Magneto-Optical (MO) Drive w/ Mounting</b> (S30122-U563-X400) <i>Includes: 4Gb Industrial Compact Flash Card (# TSD-CF-04*)</i>	4Gb
* Additional Compact Flash Cards are Available: 4Gb (# TSD-CF-04, MAT # R1343960), 8Gb (# TSD-CF-08), 16Gb (# TSD-CF-16), 32Gb (# TSD-CF-32)		

150 Cooper Rd. (F-15)  
W. Berlin, NJ 08091

www.tagcords.com  
**Telecom Assistance Group**

Telephone: (856) 753-8585  
Fax : (856) 768-7645

**Lumen / CenturyLink Approved - NEBS Certified - Stromberg Carlson DCO Drive Solutions from TAG**

**DCO MSDA 822010 CIRCUIT PACKS  
w/ EXISTING HARD DRIVE & TAPE DRIVE (w/ "MOVING PARTS")**

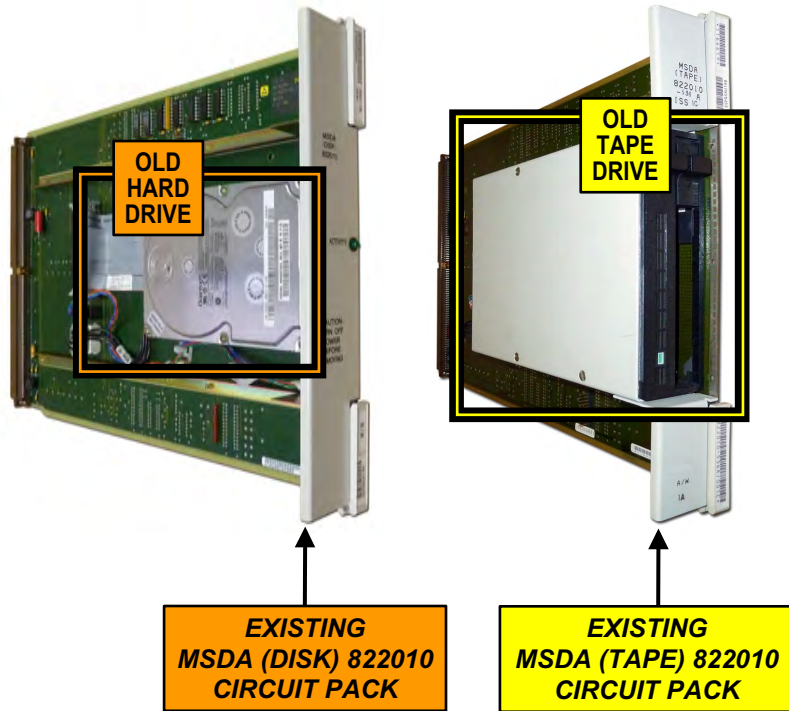

**NEW SOLID STATE DRIVES FROM TAG  
(INSTALLED ON EXISTING CIRCUIT PACKS)**

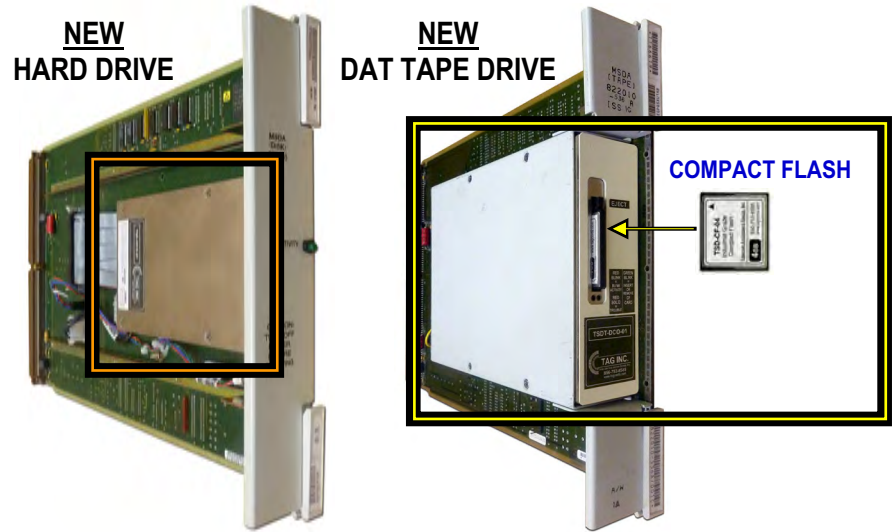

**Application:**

TAG can **REPLACE** older or failing Hard (Disk) Drives & DAT Tape Drives on existing Stromberg Carlson DCO, MSDA 822010 circuit packs with **NEW** Solid State Drives.

TAG MODEL #	USED ON EXISTING MSDA (DISK) 822010 CIRCUIT PACK
TSD-DCO-01 <b>MAT # R1355062</b>	Solid State Replacement <b>Hard Drive</b> used on: Stromberg Carlson DCO, MSDA (DISK) 822010-706, 4.5Gb
TSD-DCO-02 (CALL)	Solid State Replacement <b>Hard Drive</b> used on: Stromberg Carlson DCO, MSDA (DISK) 822010-716, 9Gb
TAG MODEL #	USED ON EXISTING MSDA (TAPE) 822010 CIRCUIT PACK
TSDT-DCO-01 <b>MAT # R1355063</b>	Solid State Replacement <b>DAT Tape Drive</b> used on: Stromberg Carlson DCO, MSDA (TAPE) 822010-536, 822010-616, 822010-646, 822010-656 <i>Includes: 4Gb Industrial Compact Flash Card (MAT # R1343960, # TSD-CF-04)</i>
TSDT-DCO-02 (CALL)	Solid State Replacement <b>DAT Tape Drive</b> used on: Stromberg Carlson DCO, MSDA (TAPE) 822010-726 <i>Includes: 4Gb Industrial Compact Flash Card (MAT # R1343960, # TSD-CF-04)</i>

150 Cooper Rd. (F-15)  
W. Berlin, NJ 08091

www.tagcords.com  
**Telecom Assistance Group**

Telephone: (856) 753-8585  
Fax: (856) 768-7645

**Lumen / CenturyLink Approved - NEBS Certified - DMS-10 (NT8T90BB) Drive Solution from TAG**

**NORTEL DMS-10 NT8T90BB MODULE  
w/ Hard Drive (w/ "MOVING PARTS")**

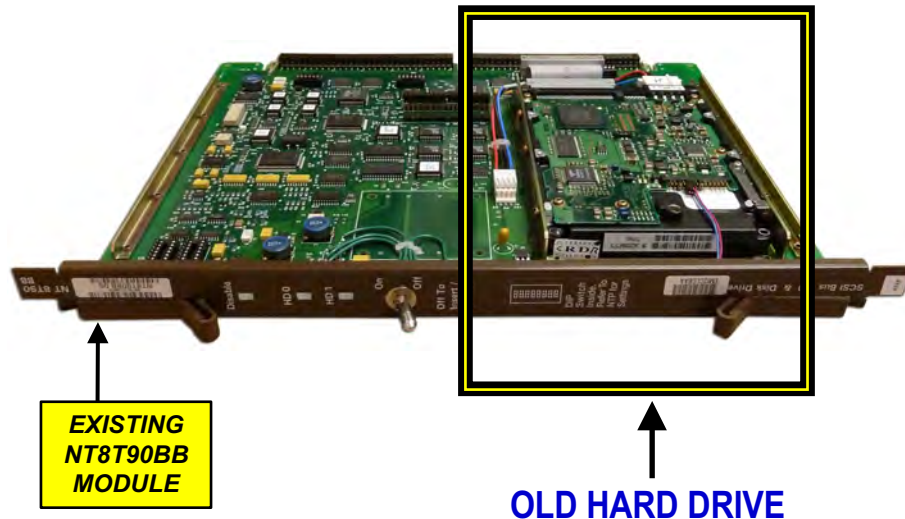

**NEW SOLID STATE DRIVE FROM TAG**

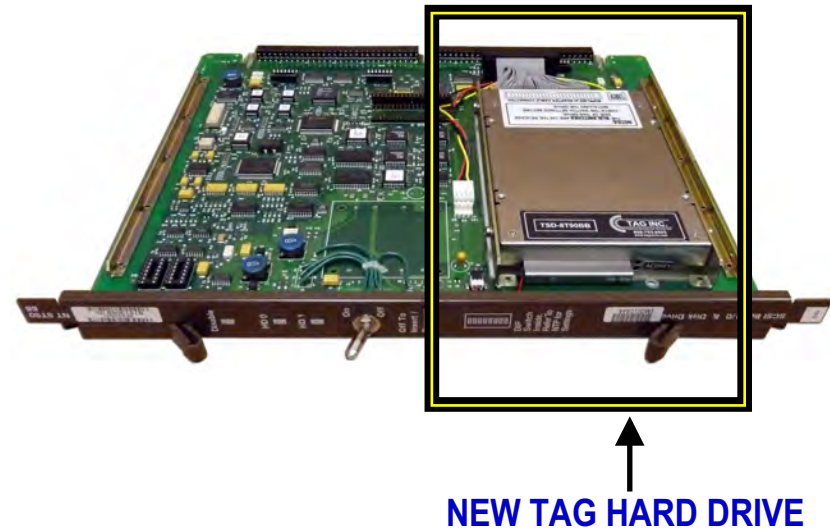

**Application:**

TAG can **REPLACE** the failing / broken Nortel DMS-10 Hard Drive in the NT8T90BB Module with a **NEW** Solid State Drive.

**NEW SOLID STATE DRIVE AVAILABLE FROM TAG**

TAG MODEL #	<b>USED IN NT8T90BB MODULE (HECI EMI2CLCBAA)</b>
TSD-8T90BB	Solid State Replacement for: Nortel DMS-10 (HECI EMI2CLCBAA) NT8T90BB Hard Drive
<b>Lumen/CLK MAT # R1350768</b>	

150 Cooper Rd. (F-15)  
W. Berlin, NJ 08091

www.tagcords.com  
**Telecom Assistance Group**

Telephone: (856) 753-8585  
Fax : (856) 768-7645



**Lumen / CenturyLink Approved - NEBS Certified - DMS-10 (NT4T32BA) Drive Solution from TAG**

**NORTEL DMS-10 NT4T32BA MODULE  
w/ Magneto-Optical (MO) Drive (w/ "MOVING PARTS")**

**NEW SOLID STATE DRIVE FROM TAG**

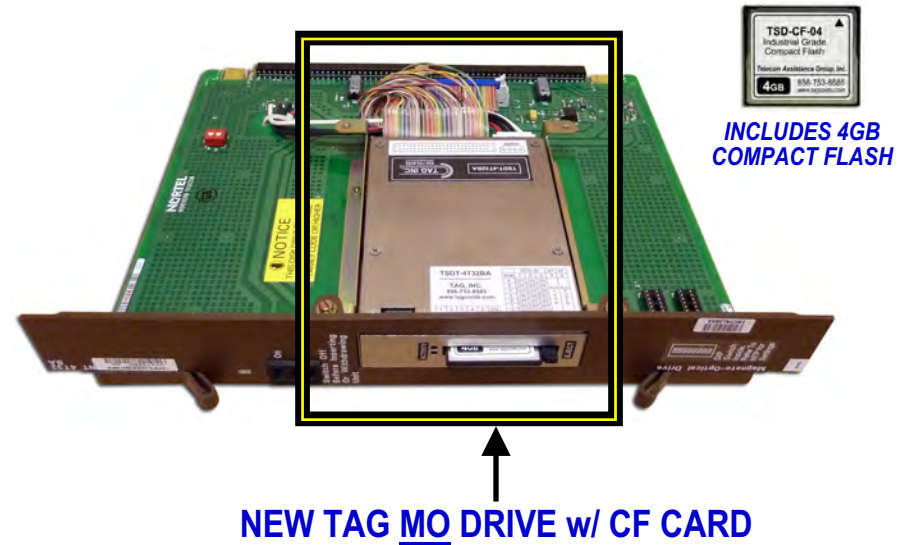
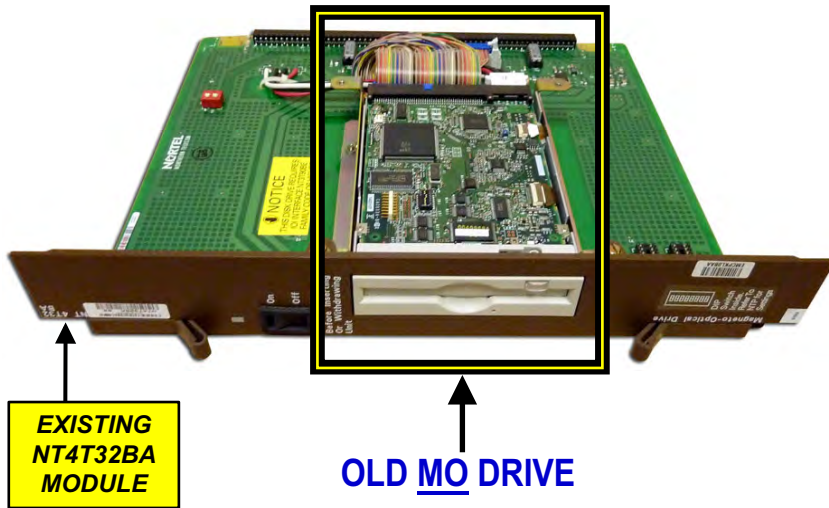

**Application:**

TAG can **REPLACE** the failing / broken Nortel DMS-10 Magneto-Optical (MO) Drive in the NT4T32BA Module with a **NEW** Solid State Drive.

**NEW SOLID STATE DRIVE AVAILABLE FROM TAG**

<b>TAG MODEL #</b>	<b>USED IN NT4T32BA MODULE (HECI EMCPKL0BAA)</b>
TSDT-4T32BA	Solid State Replacement for: <b>Nortel DMS-10 (HECI EMCPKL0BAA) NT4T32BA (Fujitsu MCF3064 SS) Magneto-Optical (MO) Drive,</b> Includes: 4Gb Industrial Compact Flash Card (# TSD-CF-04*)
<b>Lumen/CLK MAT #</b> <b>R1350767</b>	
* Additional Compact Flash Cards are Available: 4Gb (# TSD-CF-04, MAT # R1343960), 8Gb (# TSD-CF-08), 16Gb (# TSD-CF-16), 32Gb (# TSD-CF-32)	

150 Cooper Rd. (F-15)  
W. Berlin, NJ 08091

www.tagcords.com  
**Telecom Assistance Group**

Telephone: (856) 753-8585  
Fax : (856) 768-7645

**Lumen / CenturyLink Approved - NEBS Certified - Nortel DMS-100 SLM (NT9X44AD) Drive Solutions from TAG**

**NORTEL DMS-100 SLM MODULE  
w/ EXISTING DRIVES  
(2 DRIVES w/ "MOVING PARTS")**

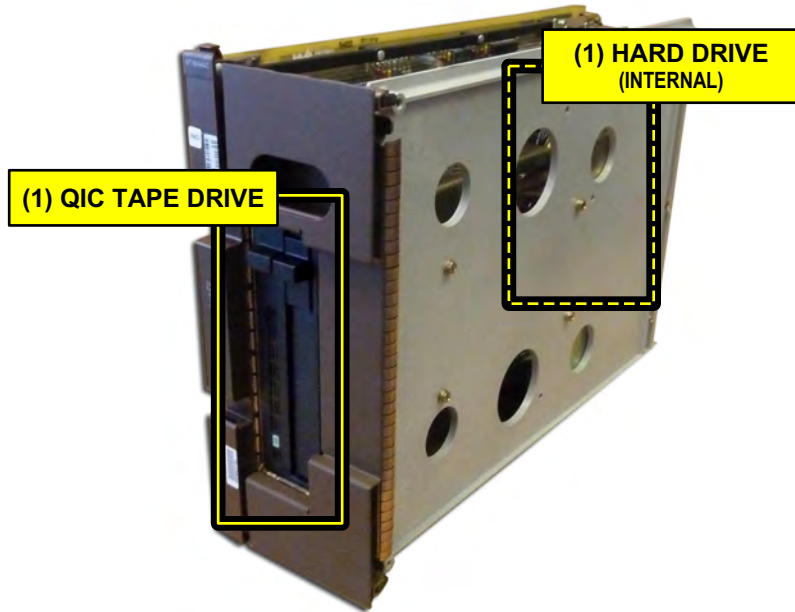

**NEW SOLID STATE DRIVES FROM TAG**



**NEW  
HARD DRIVE**



**NEW  
TAPE DRIVE**

**COMPACT  
FLASH**



**NEW SOLID STATE DRIVES AVAILABLE FROM TAG**

<b>TAG MODEL #</b>	<b>USED IN NT9X44AD MODULE (HECI ENPQAZV1AA) - (1 HD &amp; 1 TAPE DRIVE)</b>	
TSD-9X44AD-01 <b>Lumen/CLK MAT # 1457324</b>	Solid State Replacement for: <b>Nortel DMS-100 SLM, NT9X44AD (HECI ENPQAZV1AA) Hard Drive</b>	3.1 Gb
TSDT-9X44AD-02 <b>Lumen/CLK MAT # 1457386</b>	Solid State Replacement for: <b>Nortel DMS-100 SLM, NT9X44AD (HECI ENPQAZV1AA) QIC Tape Drive</b> <i>Includes: 4Gb Industrial Compact Flash Card (# TSD-CF-04)</i>	4 Gb
* Additional Compact Flash Cards are Available: 4Gb (# TSD-CF-04, MAT # R1343960), 8Gb (# TSD-CF-08), 16Gb (# TSD-CF-16), 32Gb (# TSD-CF-32)		

**Application:**

TAG can **REPLACE** the 2 failing / broken drives on the DMS SLM Module.

- (1) Hard Drive NT9X44AD 3.1GB
- (1) QIC Tape Drive 525MB NT9X4420 / NTA0643549

TAG can provide NEW Solid State Drives

150 Cooper Rd. (F-15)  
W. Berlin, NJ 08091

www.tagcords.com  
**Telecom Assistance Group**

Telephone: (856) 753-8585  
Fax : (856) 768-7645

**Lumen / CenturyLink Approved - NEBS Certified - DMS-100 (XA-CORE, NTLX07AA) DAT Drive Solution from TAG**

**NORTEL DMS-100 XA-CORE, NTLX07AA MODULE w/ DAT Tape Drive (w/ "MOVING PARTS")**

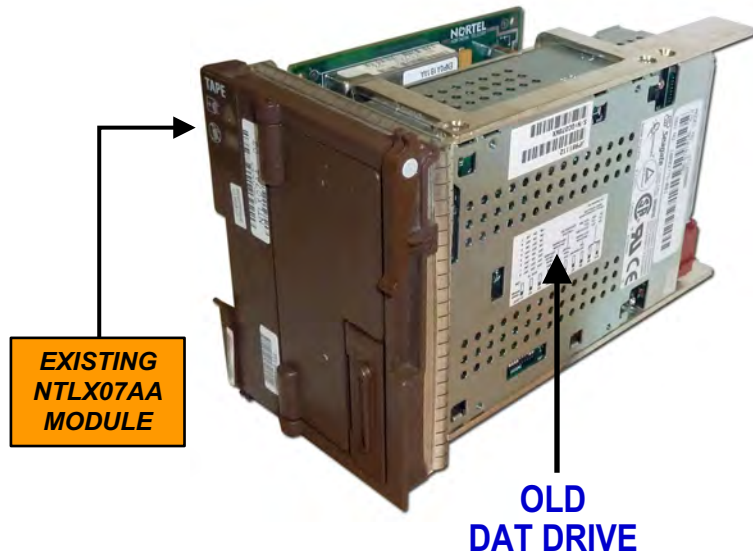

**NEW SOLID STATE DRIVE FROM TAG**

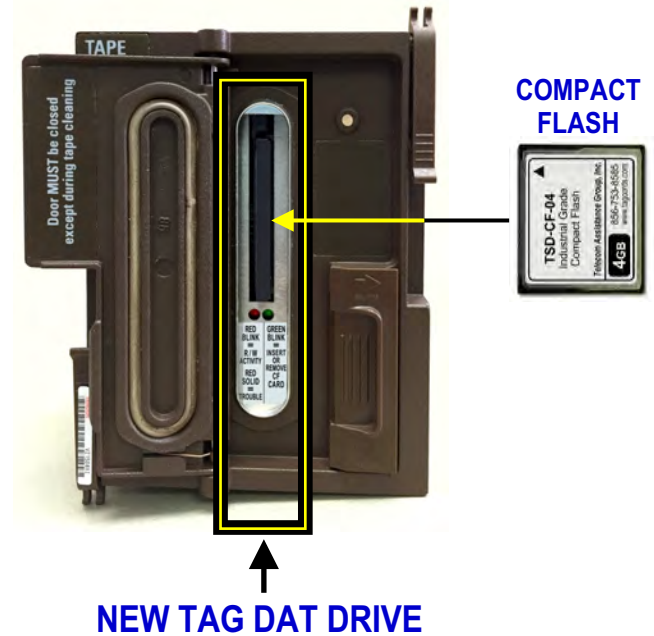

**Application:**

TAG can **REPLACE** the failing / broken Nortel DMS-100 DAT Tape Drive in the XA-CORE, NTLX07AA Module with a **NEW** Solid State Drive.

**NEW SOLID STATE DRIVE AVAILABLE FROM TAG**

TAG MODEL #	USED IN NTLX07AA MODULE (HECI ENPQA1B1AA)	
TSDT-NTLX07-01	Solid State Replacement for: <b>Nortel DMS-100 (HECI ENPQA1B1AA) XA-CORE, NTLX07AA, DAT Tape Drive</b>	4 Gb
<b><u>Lumen/CLK MAT #</u></b> <b>1495798</b>	<b>Includes: 4Gb Industrial Compact Flash Card (PN # TSD-CF-04*)</b>	
* Additional Compact Flash Cards are Available: 4Gb (# TSD-CF-04, MAT # R1343960), 8Gb (# TSD-CF-08), 16Gb (# TSD-CF-16), 32Gb (# TSD-CF-32)		

150 Cooper Rd. (F-15)  
W. Berlin, NJ 08091

www.tagcords.com  
**Telecom Assistance Group**

Telephone: (856) 753-8585  
Fax : (856) 768-7645



# DMS Replacement Terminals - Dual Session

**Model:**

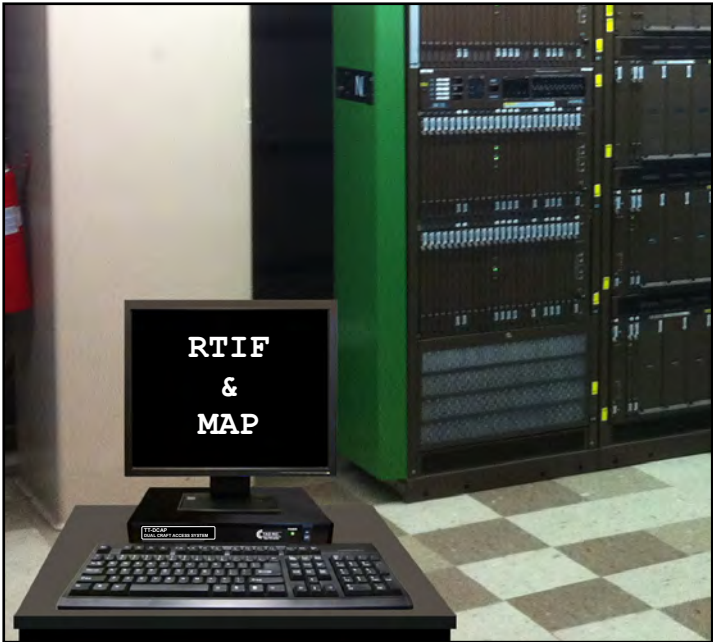
**TT-DCAP-DMSKIT**

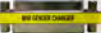
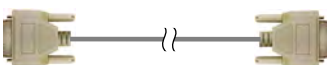

**Kit Includes:**

- (1) 17" Flat Screen Monitor
- (1) Dumb Terminal Controller
- (1) Keyboard
- (1) Quick Guide
- (2) 400700, (DB25F Gender Changer) 
- (1) 400725NTRX, (DB25F Null Adapter Cable, (2')) 
- (2) 400725SB2, (DMS Quick Connect Current Loop Adapter Cable w/ DEC Connector) 

**SPECIFICATIONS**

- VT-100 COMPATIBLE
- DUAL RS-232 INPUTS
- PRINTER OUTPUT
- LOW POWER

**Printer Port Type:**



**Parallel \***

*\* If a Serial Port is needed, please order a Parallel to Serial Adapter (PN # TT-PSA). Please call 856-753-8585 for more information.*

**Ordering Information:**

<b>TT-DCAP-DMSKIT</b>	<b>DMS Dual Session Replacement Terminal Kit</b> includes: (1) 17" Flat Screen Monitor, (1) Keyboard, (1) Dual Session Dumb Terminal Controller, (1) Quick Guide, (2) PN # 400700 (DB25F Gender Changer) (1) PN # 400725NTRX (DB25F Null Adapter Cable, (2')) & (2) PN # 400725SB2 (DMS Quick Connect Current Loop Adapter Cable w/ DEC Connector)	<b>Lumen/CLK MAT #</b> <b>1332219</b>
<b>TT-DCAP</b>	<b>DMS Dual Session Replacement Terminal</b> includes: (1) 17" Flat Screen Monitor, (1) Keyboard, (1) Dual Session Dumb Terminal Controller, (1) Quick Guide (1) PN # 400725NTRX (DB25F Null Adapter Cable, (2')) & (2) PN # 400700 (DB25F Gender Changer)	<b>1332260</b>
<b>400725SB2</b>	<b>DMS Quick Connect Current Loop Adapter Cable w/ DEC Connector</b>	<b>1332198</b>
<b>400725SBW</b>	<b>Hardwire Adapter (not shown) for 400725SB2</b>	<b>1332199</b>

150 Cooper Rd. (F-15)  
W. Berlin, NJ 08091

[www.tagcords.com](http://www.tagcords.com)

Telephone: (856) 753-8585  
Fax : (856) 768-7645

**Telecom Assistance Group**



# DMS Replacement Terminals - Single Session

**Model:**

**TT-SCAP-DMSKIT**

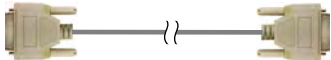

**Kit Includes:**

- (1) 17" Flat Screen Monitor
- (1) Dumb Terminal Controller
- (1) Keyboard
- (1) Quick Guide
- (1) 400700, (DB25F Gender Changer) 
- (1) 400725NTFX, (DB25F Null Adapter Cable, (2')) 
- (1) 400725SB2, (DMS Quick Connect Current Loop Adapter Cable w/ DEC Connector) 

**SPECIFICATIONS**

- VT-100 COMPATIBLE
- SINGLE RS-232 INPUT
- PRINTER OUTPUT
- LOW POWER

**Printer Port Type:**



**Parallel \***

*\* If a Serial Port is needed, please order a Parallel to Serial Adapter (PN # TT-PSA). Please call 856-753-8585 for more information.*

**Ordering Information:**

		<b>Lumen/CLK MAT #</b>
<b>TT-SCAP-DMSKIT</b>	<b>DMS Single Session Replacement Terminal Kit</b> includes: (1) 17" Flat Screen Monitor, (1) Keyboard, (1) Single Session Dumb Terminal Controller, (1) Quick Guide, (1) PN # 400700 (DB25F Gender Changer) (1) PN # 400725NTFX (DB25F Null Adapter Cable, (2')) & (1) PN # 400725SB2 (DMS Quick Connect Current Loop Adapter Cable w/ DEC Connector)	<b>1332218</b>
<b>400725SB2</b>	<b>DMS Quick Connect Current Loop Adapter Cable w/ DEC Connector</b>	<b>1332198</b>
<b>400725SBW</b>	<b>Hardwire Adapter (not shown) for 400725SB2</b>	<b>1332199</b>

150 Cooper Rd. (F-15)  
W. Berlin, NJ 08091

[www.tagcords.com](http://www.tagcords.com)

Telephone: (856) 753-8585  
Fax : (856) 768-7645

**Telecom Assistance Group**

# Single Session Dumb Terminals - Transport / DACS Equipment

**NEW TERMINAL WORKS ON  
Titan 5500, Stromberg Carlson (DCO),  
CS1, CS1L, DACS II, III, IV, Alcatel 1631 & HDSL**  
(Titan 5500 shown below)

**REMOVE & REPLACE  
OLD / BROKEN CRTs**

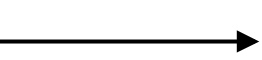

**Lumen/CLK MAT #  
1332217**

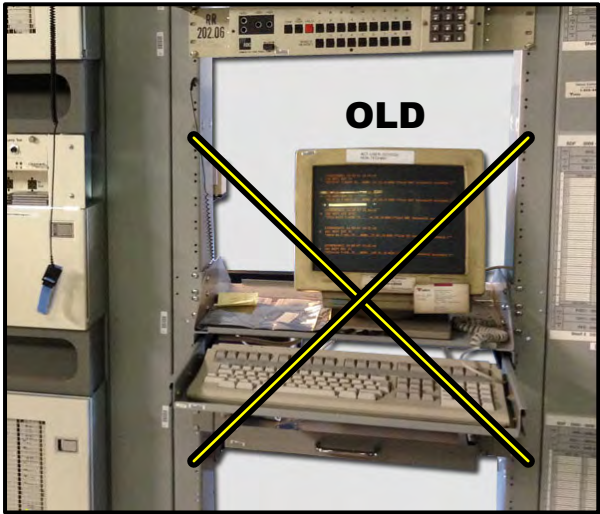

- SPECIFICATIONS**
- VT-100 COMPATIBLE
  - SINGLE RS-232 INPUT
  - PRINTER OUTPUT
  - LOW POWER

- New Terminal Includes:**
- (1) 17" Flat Screen Monitor
  - (1) Dumb Terminal Controller
  - (1) Keyboard
  - (1) Quick Guide
  - (1) 400701, (DB25M Gender Changer)

**Ordering Information:**

**TT-VT100S Single Session Dumb Terminal - Transport / DACS**  
includes: (1) 17" Flat Screen Monitor, (1) Keyboard,  
(1) Single Session Dumb Terminal Controller,  
(1) DB25M Gender Changer & (1) Quick Guide

**Lumen/CLK MAT #  
1332217**

150 Cooper Rd. (F-15)  
W. Berlin, NJ 08091

[www.tagcords.com](http://www.tagcords.com)

Telephone: (856) 753-8585  
Fax : (856) 768-7645

**Telecom Assistance Group**

# 5ESS Terminal Replacements - Dual Session

**Model:**

**TT-DCAPCE-N**



**Kit Includes:**

(1) 17" Flat Screen Monitor

(1) Dumb Terminal Controller

(1) Keyboard

(1) Quick Guide

(2) 400701,  
(DB25M Gender Changer)



(2) 400700N,  
(DB25F Gender Changer - NULL)



**SPECIFICATIONS**

- VT-100 COMPATIBLE
- DUAL RS-232 INPUTS
- PRINTER OUTPUT
- LOW POWER



**Ordering Information:**

**TT-DCAPCE-N**

**Dual Craft Access System Kit - 5ESS**

**Lumen/CLK MAT #**  
**1444029**

- includes:
- (1) 17" Flat Screen Monitor
  - (1) Keyboard
  - (1) Dual Session Dumb Terminal Controller
  - (1) Quick Guide
  - (2) PN # 400701 (DB25M Gender Changer)
  - (2) PN # 400700N (DB25F Gender Changer - NULL)

150 Cooper Rd. (F-15)  
W. Berlin, NJ 08091

[www.tagcords.com](http://www.tagcords.com)

Telephone: (856) 753-8585  
Fax : (856) 768-7645

**Telecom Assistance Group**

# 5ESS MCC Terminal w/ "Glass Printer" Feature

## NEW "Glass Printer" Feature allows Capture of ROP & Scroll Reports

### Benefits:

- CAPTURE SCROLLING REGION & ROP INFORMATION WITHOUT PAPER
- ELIMINATE OLD TERMINALS, READ ONLY PRINTERS & PAPER WASTE

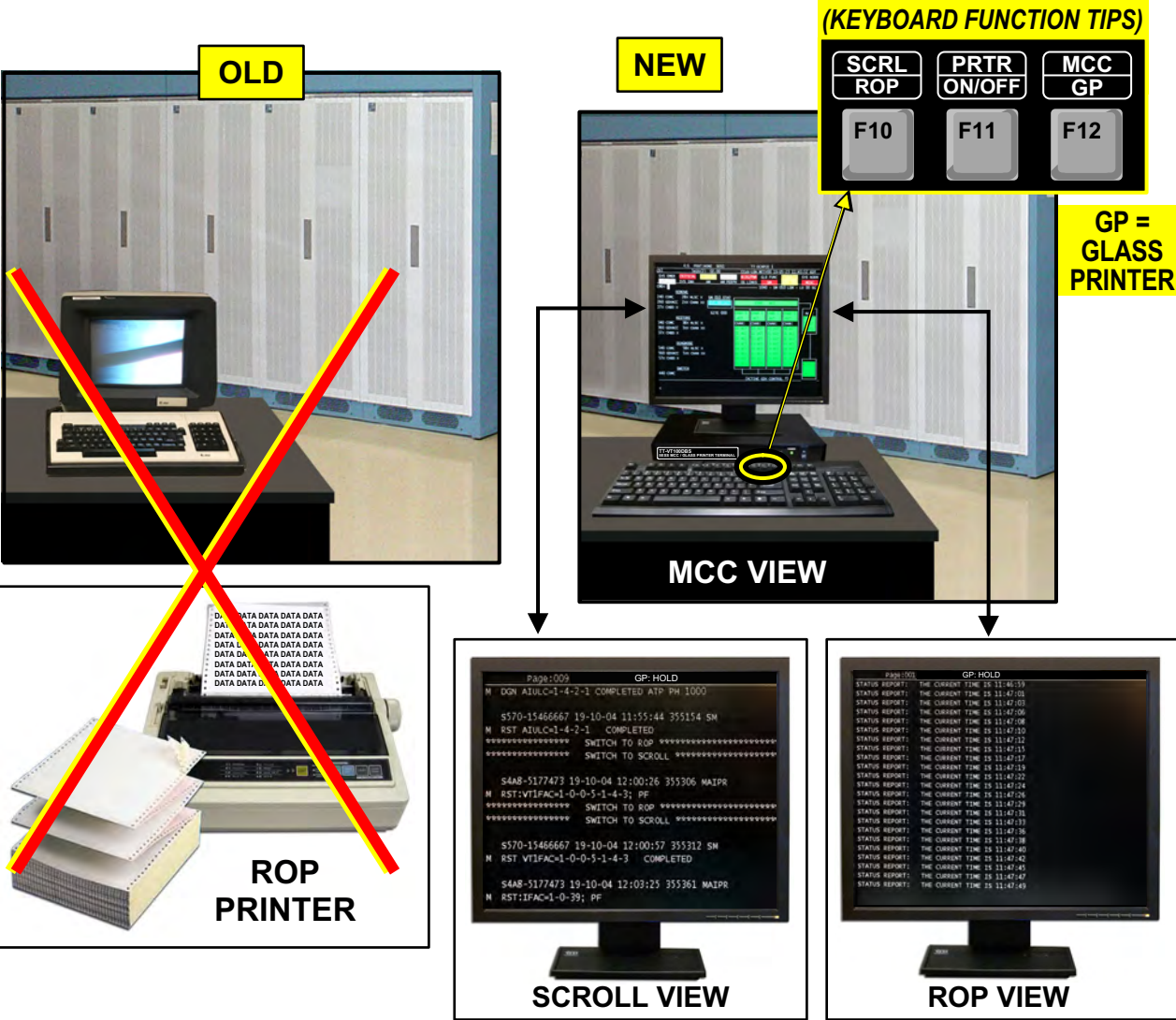

### Ordering Information:

**TT-VT100DBS 5ESS MCC Terminal w/ "Glass Printer" Feature**

includes: (1) 17" Flat Screen Monitor, (1) Keyboard,  
 (1) MCC Terminal Controller w/ Glass Printer (Capture Scroll & ROP),  
 (2) # 400701, DB25M Gender Changers & (1) Quick Guide

**Lumen/CLK MAT #**  
**1482000**

150 Cooper Rd. (F-15)  
 W. Berlin, NJ 08091

[www.tagcords.com](http://www.tagcords.com)

Telephone: (856) 753-8585  
 Fax : (856) 768-7645

# Telecom Assistance Group



# DMS-10/100 Pre-Charge Tool

# T-DMSTBT

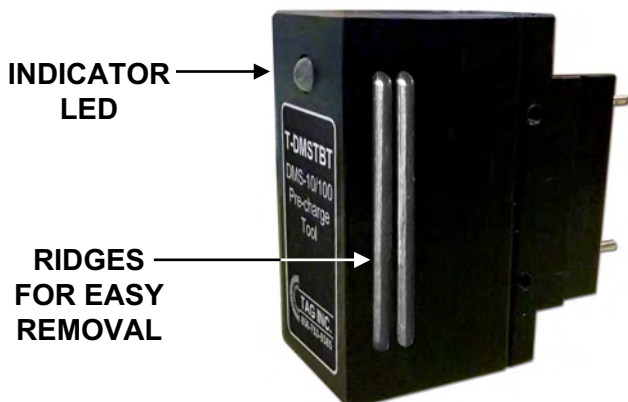

**PN # T-DMSTBT**  
 DMS-10/100 Pre-Charge Tool  
**Lumen/CLK MAT # 1463935**

*(replacement for NTA0600512)*

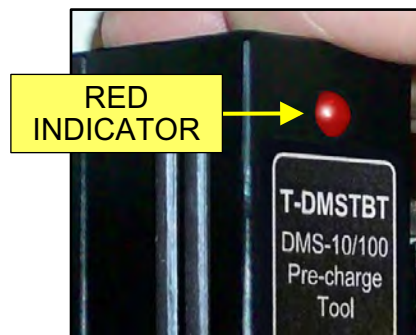

- THE INDICATOR GOES OUT WHEN IT IS SAFE TO INSTALL THE FUSE (APPROX. 10 SEC).
- IF THE INDICATOR STAYS LIT, THERE IS A LOAD OR FAULT ON THE CIRCUIT.

**Application:**

TAG's # T-DMSTBT is used to pre-charge shelf power capacitors on a DMS-10/100 switch. This allows a new fuse to be installed without seeing full in-rush surge current. The indicator light goes out when it is safe to install the fuse.

**Ordering Information:**

**T-DMSTBT**

**DMS-10/100 Pre-Charge Tool**  
*(replacement for NTA0600512)*

**Lumen/CLK MAT #**

**1463935**

150 Cooper Rd. (F-15)  
 W. Berlin, NJ 08091

[www.tagcords.com](http://www.tagcords.com)

Telephone: (856) 753-8585  
 Fax : (856) 768-7645

**Telecom Assistance Group**

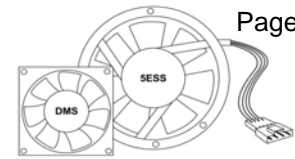

Part #	Description	MAT #
<b>5ESS FANS</b>		
TF-5ESS-01P	KS22501L3 Equiv. <b>5ESS</b> Fan w/ 3 Leads & AMP Connector w/ power prongs	1341583
TF-5ESS-01F	KS22501L3 Equiv. <b>5ESS</b> Fan w/ 3 Leads & Faston Connectors w/ power prongs	1341520
TF-5ESS-02P	KS23912L1A Equiv. <b>5ESS</b> Fan w/ 5 Leads & AMP Connector (w/ Internal Thermal Speed Control Sensor)	1330513
TF-5ESS-02F	KS23912L1A Equiv. <b>5ESS</b> Fan w/ 5 Leads & Faston Connectors (w/ Internal Thermal Speed Control Sensor)	1330515
TF-5ESS-03P	KS23912L2 Equiv. <b>5ESS</b> Fan w/ 4 Leads & AMP Connector	1338991
TF-5ESS-04P	KS22501L3A Equiv. <b>5ESS</b> Fan w/ 5 Leads & AMP Connector	1341163
TF-5ESS-04F	KS22501L3A Equiv. <b>5ESS</b> Fan w/ 5 Leads & Faston Connectors	1332759
TF-5ESS-10P	KS23398L2 Equiv. <b>5ESS</b> ISLU (Square Fan) w/ 5 Leads & AMP Connector	1341565
<b>ADTRAN FANS</b>		
TF-TA3000-01	<b>Adtran TA3000</b> , 48V Fan w/ 3 Wire Plug (use in HECI: M3PQ0AV, 1181006L1)	1479267
TF-TA5K-01	<b>Adtran TA5000</b> , 48V Fan w/ 4 Wire Plug	1359596
TF-TA5K-02	<b>Adtran TA5000</b> , 48V Fan w/ 3 Wire Plug	1359595
<b>ALCATEL FANS</b>		
TF-ALC-01	<b>Alcatel 1000/7300</b> , 48V Fan w/ Tach (use in 3EC 15478, 3EC 37933 & 3EC 36760 Fan Trays)	1337633
TF-AL7300-02	<b>Alcatel 7300</b> , 48V Fan w/ Internal Sensor & Tach output (use in 3EC 16697 (XXXX))	1341521
TF-DSCECS1-01	<b>DSC / Alcatel ECS1</b> , 48V Fan	1341522
TF-ALC1603-01	<b>Alcatel 1603</b> , 48V Fan w/ 3 Wire Plug (use in Low-Volume Fan Tray # 625052-000-0XX)	1475327
TF-ALC1631-01	<b>Alcatel 1631</b> , 48V Fan (Square) w/ Power Prongs (use in Assembly # 695-3363-302)	1359594
TF-ALC1631-02	<b>Alcatel 1631</b> , 48V Fan (Round) w/ Power Prongs & Tach Lead (use in #3AL45446AA)	1359611
TF-ALC1631-03	<b>Alcatel 1631 APS</b> , 48V Fan (Square) w/ Pwr Prongs & Tach Lead (use in #695-8489-001)	
TF-ALC1680-01	<b>Alcatel 1680 OGX</b> , 48V Fan (Round) w/ Pwr Prongs & Tach Lead (use in #3EM04820AA)	
<b>BIGBAND / ADC FANS</b>		
TF-BIGBND-01	<b>BigBand</b> , 12V w/ 3 Wire Open End Fan (w/ Speed Control)	1341523
TF-BIGBND-03SR	<b>BigBand</b> Shelf / Door Repair	7005999
TF-BIGBPS-01	12V Fan (40mm) w/ 3 Wire Plug for BigBand (FTTP bays) & ADC RF Worx Power Supplies	
<b>CIENA FANS</b>		
TF-CN3916-K50	<b>Fan Kit for Ciena 3916 # 170-3916-904</b> , (Kit includes (50) 12V (40x40x10mm) Fans)	1501840
TF-CN1600-01	<b>Ciena 1600 DWDM</b> , 48V Fan (fan only, mounting bracket is not included)	1341524
TF-DN7100-01	<b>Ciena DN7100</b> , 12V Fan w/ 3 Wire Plug	
TF-DN7100-02	<b>Ciena DN7100</b> , 12V Fan w/ 3 Wire Plug	
<b>DSC DEX600E FANS</b>		
TF-DEXLAP-01	<b>DEX600E</b> MSP Bay Fan (LAP Fan)	1341525
TF-DEXDSI-01	<b>DEX600E</b> DSI Bay Fan (DSI (FAIC) type cards)	1341526
TF-DEXDTI-01	<b>DEX600E</b> DTI Bay Fan (DTI (AMM) type cards)	1341527
TF-DEXCS3-01	<b>DEX600E</b> CS3, 48V Fan	1341528
<b>CISCO 15454 / CALIX E7 / KENTROX FANS</b>		
TF-C15454-01	<b>Cisco ONS 15454</b> , 48V Fan w/ 3 Wire Right Angle Connector	1356197
TF-CLXE7-01	<b>Calix E7-2 FTA2 Fan Unit</b> , 12V (40mm x 20mm) Fan for w/ 4 Wire Plug	1490737
TF-AI-180	<b>Kentrox AISwitch Series 180</b> , 48V Cooling Fan	1437966
<b>DATAKIT / FUJITSU / GALAXY RECTIFIER FANS</b>		
TF-DATAKIT-01	24V Fan for <b>Datakit System</b> w/ 3 Wire, 4 Pin Connector	
TF-FW4500-01	48V Fan for <b>Flashwave 4500</b> Fan Unit w/ 4 Wire Plug (for # FC9580FAN1,SNPQUG5AB)	
TF-FLM150-01	48V (80mm) Fan for <b>Fujitsu FLM 150 Fan Tray</b> w/ 3 Wire Plug	
TF-GLX595LTB-01	48V Fan for <b>Galaxy 595LTB Rectifier</b> w/ 4 Wire Plug	1462387
<b>LORAIN / MARCONI RECTIFIER FANS</b>		
TFT-MRECT	<b>New Fan Tray Assembly for Vortex Rectifier</b> (Lorain/Marconi 104545) (V200D50)	1341614
TF-MREC-01	<b>Vortex Rectifier (Lorain / Marconi) (V200D50)</b> , 24V Fan w/ 3 Wire Open End	
TF-MREC-02	<b>Vortex Rectifier (Lorain/Marconi)</b> , 24V Fan & 3 Wire Plug (use in V200E50)	1341615
TF-RHM400-01	<b>RHM-400/800 Rectifier Unit (Lorain/Marconi)</b> , 220VAC Fan	1341529
TF-LRA50B50-01	<b>Lorain Rectifier (A50B50)</b> , 48V Fan w/ 2 Wire Plug	1444636
TF-LRV50B50-01	<b>Lorain Rectifier (V50B50)</b> , 24V Fan w/ 3 Wire Plug	

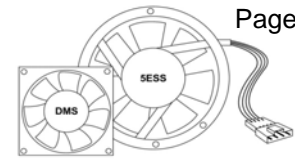

Part #	Description	MAT #
<b>LUCENT FANS (CBX500, DDM-2000, FT-2000, METROPOLIS, DACS III / IV)</b>		
TF-DDM201	Lucent DDM-2000, 24V Fan	1341530
TF-DDM201-KIT1	Lucent DDM-2000, 24V Fan Kit w/ Mounting Plate	1341531
TF-DDM202	Lucent DDM-2000, 48V Fan (fan only, mounting not included)	1359610
TF-CBX500-01	Lucent CBX500 OCD, 12V Cooling Fan w/ 3 Wire Pins	1336683
TF-FT201	Lucent FT-2000, 48V Fan w/ 3 Wire Plug	1341533
TF-DMXMET-01	Lucent Metropolis DMX, 48V Fan w/ 4 Wire Plug	1341532
TF-DMXMET-02	Lucent Metropolis DMX Access Multiplexer, 48V Fan w/ 4 Wire Black Plug	
TF-DACS3/4-01	Lucent DACS III / IV, 48V Fan w/ 4 Wire Plug (Equiv. to KS23913L1)	1341534
TF-DACS3/4-02	Lucent DACS III / IV, 48V Fan w/ 5 Wire Plug (Equiv. to KS23913L1)	1359609
TF-DACSK1-01	Alcatel-Lucent DACS K01, 48V Fan w/ 3 Wire Open End (includes (2) butt splices)	
<b>NEC FANS</b>		
TF-NEC-01	NEC, 48V Fan (fan only) (FD-31201A / FD-32401A)	1341428
TF-NEC01-KIT1	NEC, 48V Fan Kit w/ Mounting & Guard Grill (FD-31201A / FD-32401A)	1341429
TF-NEC-02	NEC, 48V Fan (fan only) (ITS-2400)	1341500
TF-NEC02-KIT1	NEC, 48V Fan Kit w/ Mounting & Guard Grill (ITS-2400)	1341501
TF-NEC-03	NEC, 48V Fan (fan only) (ITS-2400V FL)	1341502
<b>NORTEL FANS (DMS, Carrier VoIP, DPCC SuperNode "Squirrel Cage" Blowers)</b>		
TF-DMS01	DMS-100, 48V Fan w/ Power Prongs (use in NT3X90AC / NTB63AA fan trays)	1330636
TF-DMS01-100	DMS-100, 48V Fan w/ Power Prongs (use in NT3X90AC / NTB63AA trays) (PKG OF 100)	1341503
TF-DMS02	DMS-1U, 48V Fan Pwr Prongs w/ 4 clear, unthreaded (use in NT3X90AC / NTB63AA trays)	1341504
TFT-DMS48KIT3	DMS-100 (NT3X90AA / NT3X90AB), 24VAC to 48VDC Fan Tray Conversion Kit 3	1353218
TFT-DMS48KIT4	DMS-100 (NT3X90AA / NT3X90AB), 24VAC to 48VDC Fan Tray Conversion Kit 4 (NEW Kit - includes (5) 48V Fans & Fan Control Board w/ built in Sensors (no paddles needed))	1456790
<b>TFT-3X9013T ** NEW **</b>	<b>TAG Universal DMS-100 3X9013 Fan Tray</b> (NEW TRAY is pre-assembled w/ (5) NEW fans, Alarm Board, Wiring Harness w/ Connector & Universal Mounting Holes for NT3X90AA, NT3X90AB, NT3X90AC & NT3X90AF cooling units) - No 24VAC Inverters - No Paddle Sensors	1492217
TF-DMS03	DMS-100, 48V Fan w/ TTL Tach & 3 Wire Plug (use in NT3X90AF fan trays)	1330361
TFC-3X90AF-01	DMS-100, Fan Alarm Board for the NT3X90AF Cooling Fan Unit	1475822
TF-DMS04AC	DMS-100, 24VAC Fan w/ Power Prongs	1341495
TF-RX50FF-01	DMS SDM, 12V Fan w/ 3 Wire Plug & Speed Control (use in Nortel shelf # NTRX50FF)	
TF-DMS-NTRX91	DMS-100, 48V Fan (use in NTRX91AA / NTOX91AA, CLEI: ENMYACM)	1349234
TF-DMS10-01	DMS-10, 48V Fan w/ Power Prongs	1341506
TF-DMS-FOS	Nortel IW SPM-IP, 48V Fan for NTLX56AA Fan Assemblies (fan only)	1341507
TF-MG9K-01	Nortel / GENBAND Media Gateway 9000, 48V Fan w/ 3 Wire Plug (for NTNY18AA)	1359401
TLMP-DMFA-10	DMS Fan Alarm Repl. Lamp ("Fan Fail" / "Frame Fail") (QTY of 10)	1474165
TLMP-DMFA-25	DMS Fan Alarm Repl. Lamp ("Fan Fail" / "Frame Fail") (QTY of 25)	1474166
TLMP-DMSA-10	DMS Aisle Alarm Repl. Lamp (QTY of 10)	1474167
TF-DMSLGN6-01	DMS-500/250 DPCC (225mm) Impeller Fan for XA-Core Blower Drawer w/ 4 Wire Plug (fan only, use in existing tray # NLX10AA, drawer # NTLX11AA)	
TF-DMSMCL-02	DMS-100 Dual-Scroll Blower Replacement Unit w/ (1) 4 pin plug & (1) 3 pin plug (includes (1) 3 pin adapter cable (used in NT9X950 "w/ hanging blowers" (replaces # A0383325 & A0381714))(commonly found in DPCC / LIM / ENET bays)	
TFC-DMSAPW-3	Alarm Board Replacement for DMS LIM / ENET Blower	
TF-DMSLGN5	DMS-100 DPCC SuperNode Blower "Squirrel Cage" Replacement w/ Internal Sensor (use in NT9X01XX DPCC, (replaces A0345301))	1355241
TF-DMSLGN5A	DMS-100 DPCC XA-Core SuperNode Blower "Squirrel Cage" Replacement w/ 4 Wire Square Plug Adapter Cable (# TFCS-DMSLGN5F2S) (use in NT9X01BC DPCC w/ Power Distribution Alarm Board (replaces A0345301))	
<b>SIEMENS EWSD FANS</b>		
TF-EWSD-01	Siemens EWSD, Square 48V Fan w/ Power Prongs (fan only, use with existing guard grill)	1341508
TF-EWSD-02	Siemens EWSD, Round 48V Fan w/ Power Prongs (fan only, use with existing guard grill)	
<b>STP RING NODE / PATHTRACK (JDSU) / TELLABS FANS</b>		
TF-STPRN-01	STP Ring Node Frame/Cabinet, 48V Fan w/ 5 Wire Plug	
TF-HCU1500-01	JDSU PathTrak HCU 1500, 24V Fan w/ 2 Wire Plug	
TF-TL6500-01	Tellabs 6500, 12V Fan w/ 4 Wire Plug	

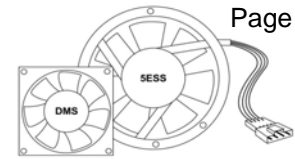

Part #	Description	MAT #
<b>STROMBERG CARLSON DCO FANS</b>		
TF-DCOCMF-01	48V Fan for <b>Stromberg Carlson DCO CMF Bay w/ 3 Leads &amp; Fastons</b>	
TF-DCODCF-01	48V Fan for <b>Stromberg Carlson DCO DCF Bay w/ 3 Leads &amp; Spade Lugs</b>	
TF-DCONHD-01	48V Fan for <b>Stromberg Carlson DCO Non-HD CMF Bay w/ 2 Wire Open End</b>	1441092
TF-DCOMEF-01	48V Fan for <b>Stromberg Carlson DCO MEF Bay (80mm x 45mm) w/ 3 Wire Plug</b>	1441093
TF-DCO-02	48V Fan for <b>Stromberg Carlson DCO CMF / DTF Bay w/ 3 Leads &amp; Fastons</b>	1439624
<b>TELCO SYSTEMS FANS (EDGE LINK 100 / AXX330G1, M560)</b>		
TF-EL100	<b>Edgelink 100, Fan (40mm)</b>	1341510
TF-EL100DET	<b>Edgelink 100, Detector PC Board (Equiv. to CCA591G1)</b>	1341511
TF-EL100-KIT2	<b>Edgelink 100, Fan Kit (40mm)</b>	1341512
TF-EL100-02	<b>Edgelink 100, Fan (35mm)</b>	1341513
TF-EL330-01	<b>Edgelink AXX330G1, Fan (80mm) w/ 3 Wire Plug</b>	
TF-TEL560-01	<b>Telco Systems M560 Fiber Optic Terminal, 48V Fan</b>	1341509
<b>WAVESTAR / WIDEBAND 3190 FANS</b>		
TF-WSTR-01	<b>WaveStar TDM 10G, 48V Fan w/ 3 Wire Plug</b>	1341514
TF-WB3190	<b>Wideband 3190, 48V Fan w/ 3 Wire Plug</b>	1341515
<b>OSP CABINET / TRAY FANS &amp; ALARM CONTROL BOARDS</b>		
TF-NTOPAC	48V Fan for <b>Nortel Opac / OPM Cabinet w/ Round Weatherproof Connector</b>	1337634
TF-NTOPAC-3	48V Fan for <b>Nortel Opac / OPM Cabinet w/ 3 Wire Open End (no connector)</b>	1341516
TF-NTOPAC-02	48V Fan for <b>Nortel Opac / OPM Cabinet w/ Sealed 3 Pin Plug</b>	1337635
TF-NTOPAC-04	48V Fan for <b>Nortel Opac / OPM Cabinet w/ Sealed 3 Pin Plug</b>	1341517
TFG-162KIT-01	<b>Guard Grill Repl. Kit for Round 162mm Fans (includes hardware)</b>	
TF-NTOPAC-05	48V Fan for <b>Nortel Opac Access Node Tray / 800A w/ 3 Wire (FPS Lead) &amp; 3 Pin</b>	7017863
TF-NTOPAC-05F	48V Fan for <b>Nortel Opac Access Node Tray w/ Power Prongs, Untermin. FPS Lead</b>	
TF-NTANCFT-01	48V Fan for <b>Nortel Access Node/Charles Fan Tray (92-FAN840-X) w/ 3 Wire Plug</b>	
TF-DMS06	48V Fan for <b>BFU in DMS-100 OPM Cbnt w/ Pwr Prongs &amp; Unterminated Tach Lead</b>	1359400
TFR-8X06ABT	<b>Tray Refurbish-Paddleless Alarm Conversion Upgrade for DMS OPM NT8X06AB</b>	
TF-SLC201-02	48V Heat Exchanger for <b>80 Type Cabinet w/ Round Screw on Conn. (KS23912L4)</b>	1337731
TFC-114A-01	<b>114A Fan Control Unit for 80 Type Cabinet Heat Exchangers (equiv. to 106894934)</b>	1355243
TFC-LU4-01	<b>Alarm Control Board for Lucent 4A/4B, 4G/SLC2000 Trays &amp; 114A Control Units</b>	1355244
TF-SLCBC-01	48V Battery Cooling fan for <b>80 Type Cabinet w/ 3 Wire Plug</b>	1461343
TFC-116A-01	<b>Alarm Control Board for Lucent 116A Battery Fan Unit (customer supplied bracket)</b>	1459078
TF-SLC201	48V Fan for <b>SLC 2000 - Lucent 4A/4B Tray w/ 5 Wire Plug (KS23912L6 equiv.)</b>	1336047
TF-SLCAPW-01	(1) 48V Fan for <b>SLC 2000 Cabinet - Reltec/Mclean APW Tray w/ 3 Wire Open End</b>	1358927
TF-SLCAPW-04	(4) 48V Fans for <b>SLC 2000 Cabinet - Reltec/Mclean APW Tray w/ 3 Wire Open End</b>	1358928
TFC-SLCAPW-4	<b>Alarm Control Board for Reltec/Mclean APW Fan Tray</b>	1459111
TF-LU2A	48V Fan for <b>Lucent 2A Fan Tray w/ 3 Leads &amp; Fastons (KS22501L5 equiv.)</b>	1336048
TF-LU2B	48V Fan for <b>Lucent 2B Fan Tray w/ 3 Wire Plug (KS22501L5A equiv.)</b>	1336049
TF-LU2C	48V Fan for <b>Lucent 2C Fan Tray w/ 3 Wire Plug (KS22501L5A equiv.)</b>	1336060
TFC-LU2BC-01	<b>Alarm Control Board for Lucent 2B &amp; 2C Fan Trays</b>	1458909
TF-LU2C-02F	48V Fan for <b>Lucent 2C Fan Tray w/ 3 Wires &amp; Faston Connectors</b>	
TF-ES660-01	24V (60x25mm) Fan for <b>Lucent ES660 Rectifier Unit w/ 2 Wire Plug</b>	
TF-RECARGUS-01	12V (80mm) Fan for <b>Argus Rectifier w/ 2 Wire Plug</b>	
TF-RECARGUS-02	24V (80mm) Fan for <b>Argus Rectifier w/ 2 Wire Right Angle Plug</b>	1474133
TF-RECARGUS-03	24V (80mm) Fan for <b>Argus Rectifier w/ 2 Wire Right Angle Plug &amp; Threaded Inserts</b>	
TF-RECARGUS-04	12V (120mm) Fan for <b>Argus Rectifier w/ 2 Wire Open End</b>	
TF-ALC7330-4	<b>Alcatel 7330 VRAD Fan Kit w/ Quick Install Template Plate</b>	1341518
TF-ALC7330-C	(1) 48V Fan for <b>Alcatel 7330 VRAD Tray w/ 3 Wire Open End (for splicing)</b>	1341616
TF-ALC1218-01	24V Fan for <b>Alcatel 1218 Cabinet Fan Trays w/ 2 Wire, 3 Pin Connector</b>	
TF-ALC1218-02	48V Fan for <b>Alcatel 1218 Cabinet Roof w/ 2 Unterminated Leads</b>	
TF-ALC7342-01	48V Fan for <b>Nokia 7342 Rolt Fan Tray w/ 4 Wire Plug</b>	
TF-COM6DF-01	<b>48V Fan for CommScope Cabinet, 6D/F Bay w/ Internal Thermal Sensor &amp; 3W, 6 Pin</b>	1355242
TF-COM6DF-02	48V Fan for <b>CommScope Cabinet, ALP HX Door w/ 5 Wire, 6 Pin Connector</b>	
TF-COM6DF-02R	48V Fan for <b>CommScope 52/82 Cbnt, HX Door w/ 5W, 6 Pin (w/10k thermistor cable)</b>	1465437
TF-COM6DF-04	<b>48V Fan for CommScope Cabinet, 6D/F Bay w/ Internal Thermal Sensor &amp; 3W, 4 Pin</b>	1466315
TF-COM6BC-01	48V Fan for <b>CommScope Cabinet, 6B/C Battery/ALP HX Door w/ 3 Wire, 4 Pin</b>	1439621
TF-COM52E-01	48V Fan for <b>CommScope 52E Cabinet, Battery w/ (1) 2W, 4 Pin &amp; (1) 2W, 2 Pin</b>	1466728

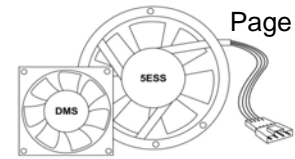

Part #	Description	MAT #
<b>OSP CABINET / TRAY FANS &amp; ALARM CONTROL BOARDS - continued from previous page</b>		
TFT-COM48B-01	"Salt Air Door Fan Tray" 3-Fan Stainless Steel Assembly for CommScope ALP 448/248 HX Door Fans (includes: (3) NEW 48V FANS (# TF-COM6DF-02B) & Grommet)	
TF-FUJ6200-01	48V Heat Exchanger for Fujitsu 6200 Cabinet w/ 5 Wire Plug	1359018
TF-FUJ6200-02	48V Fan for Lorain/Marconi M.P.S. 428212000 Shelf in Fujitsu 6200 w/ Power Prongs	
TF-FUJ6200-03	48V Fan for Fujitsu 6200 Cabinet Tray w/ 3 Wire Open End & Power Prongs	
TF-CREX-01	48V Fan for NEC C-REX Cabinet w/ 4 Wire Plug (use in Zhone ISC-303 trays)	1355199
TF-CREX-02	48V Fan for NEC C-REX Cabinet w/ 2 Wire Open End (use in # F2876A)	1355240
TFC-F2876A	Alarm Control Board Replacement for NEC Fan Shelf # F2876A	1479394
TF-CREX-03	48V Fan for NEC C-REX Cabinet ECU w/ 3 Wire Open End (use in NEC Y4899A/74884A)	1461017
TF-DISCSCPU-01	48V Cooling Fan for DISC*S CPU w/ 2 Wire Open End (fan only, use with existing bracket)	1479944
TF-CN5150HX-01	48V HX for Telamon / Ciena 5150 EMUX Cabinet Door w/ 4 Wires & Seated Connector	
TF-AI-SCT-01	48V (80mm) Fan for AISCOUT w/ 3 Wire Right Angle Plug	
TFT-SLC96-AC01	110VAC Fan w/ Bracket Assembly for SLC96 (36 Type) Cabinet (KS22099L5 Equiv.)	1356198
TFT-SLC96-AC01L	110VAC (Low Temp) Fan w/ Bracket Assembly for SLC96 (36 Type) Cbnt (KS22099L5)	
TF-SLC96-AC02	110VAC Fan (fan only) for SLC96 (36 Type) Cabinet (use in KS22099L5)	1356199
TF-LS2000-01	48V Fan for Litespan 2000 PDFA w/ 3 Wire Plug & Guard Grill (use in # 500-1126-723)	1341519
TFC-PDFA-X2	Alarm Control Board for Litespan 2000 PDFA Trays (use in Fan Tray # 500-1126-723)	
TF-LS2000-02	48V Fan for Litespan 2000 High Velocity PDFA w/ 3 Wire Connector	1356400
TFC-PDFA-01	Alarm Control Board for Litespan 2000 HV PDFA Fan Trays (use in # 509-0000-086/163)	
TF-LS2000-03	48V Heat Exchanger for Litespan 2000 Cabinet w/ Unterminated Leads	1359389
TF-LS2KSB-01	48V Heat Exchanger for Litespan 2000 Cabinet Heat Stack w/ Power Prongs	1496549
TF-LS2000-44	Litespan 2000 DFA Fan Kit (w/ (4) 48V Fans & Wiring Harness w/ 12 Wire Plug)	1445489
TF-LS2000-04	(1) Individual 48V Fan for Litespan 2000 DFA Tray w/ 3 Wire Open End (for splicing)	1445620
TFC-DFA-01	Alarm Control Board for Litespan 2000 DFA Fan Trays (use in tray # 500-1100-XXX)	1458948
TF-ACABTZ-01A	48V HX (Tarzan) for Litespan 2000 (LSC-2030) Cabinet (includes Adapter Cable)	1359388
TF-ACABLHX-01	48V Heat Exchanger (Lower) for Litespan 2000 (LSC-2030) Cabinet	1460436
TF-LRA25B50-01	24V Fan for A25B50 Rectifier Unit (Lorain / Marconi) w/ 3 Wire Plug	
TF-LPCM-01	24V Fan (80mm) for V15F50/P Lorain Power Conversion Module w/ 3W Male Plug	
TF-LPM-01	48V Fan for Lorain Power Module w/ Power Prongs (fan only - use in # 427215900)	
TF-MESACL-01	48V Fan for Marconi Current Limiter w/ 3 Wire Plug	
TF-MCABTZ-01	48V Heat Exchanger (Tarzan) for Marconi Mesa "Top" HX Cabinet w/ 3 Wire Plug	1359387
TF-MESA6-01	48V Heat Exchanger for Marconi Mesa "Bottom" HX Cabinet w/ 3 Wire Plug	1359091
TF-MARCTOP-01	48V Fan for Marconi Cabinet (Top/Inside) w/ Power Prongs	
TFC-FA400-01	Alarm Control Board Replacement for Marconi Mesa Master Tray	1479565
TF-FA400-01	48V Fan for Marconi Mesa Cabinet Master Fan Tray w/ 3 Wire Plug	1439622
TF-FA400-02	48V Fan for Marconi Mesa Cabinet Slave Fan Tray w/ 3 Wire Plug	1439623
TFC-MARC6-01	6 Position Environmental Control Unit (ECU) for Marconi Cabinet (supports 6 HX fans)	1461075
TF-MESA384-01	48V (External) HX for Mesa DSLAM 384 Cbnt w/ 4 Wire (Round)(F) Weatherproof Plug	
TF-MESA384-02	48V (Internal) HX for Mesa DSLAM 384 Cbnt w/ 4 Wire (Square) Female Plug	
TFC-MESA-04	4 Port Environmental Control Unit (ECU) (used in Mesa 2 - DSLAM 192 & 384)	
TFC-MESA-02	2 Port Environmental Control Unit (ECU) (used in Mesa 2 - DSLAM 192 Type Cabinets)	
TFC-MESA246-01	6 Fan Environmental Control Unit (ECU) for Remote Cabinet Sites	1461124
TFCS-MESA246-08	Extension Cable for Mesa Fan Controllers, (8')	1475550
TFC-WORX-FAM1	PowerWorx Front Access Fuse Panel (Equiv. to ADC # TFA-FAM)	
TFT-NXWDL-02	TAG Universal 19/23 "Harsh Environment" Cabinet Fan Tray (fits 19" & 23" bays)	1472248
TFT-NXTLEV-03MC	TAG Fan Tray for Next Level Cabinet (includes NEW Fan Tray & (3) NEW 48V Fans)	1444040
TF-NXTLEV-03	48V Fan Assembly for Next Level Cabinet Fan Trays (includes (3) 3 Wire Fans)	1358901
TF-DCORLS-01	48V Fan for Stromberg Carlson DCO RLS Cabinet Tray w/ 3 Fastons & Power Prongs	1481914
TF-SPB-AC01	120VAC Fan for Seiscor / Pulsecom "B" Cabinet w/ Power Prongs	
TF-SPD-AC01	110VAC Fan for Seiscor / Pulsecom "D" Cabinet w/ Power Prongs & Guard Grill	
TF-UMC1000-01	48V Fan (120mm) for Tellabs UMC1000 Tray w/ 3 Wire Plug (use in AFC Tray w/ 6 fans)	1466657
TFC-UMC1000-06	Alarm Control Board for Tellabs UMC1000 Tray (use in AFC tray w/ 6 fans)	
TF-UMC1000-02	48V Fan (80mm) for Tellabs UMC1000 Tray w/ 3 Wire Plug (use in AFC Tray w/ 10 fans)	1466656
TF-UMC1000-03	48V Fan (120mm) for Tellabs UMC1000 Tray w/ 4 Wire Plug (use in AFC Tray w/ 8 fans)	1466761
TF-UMC672-01	48V Fan for UMC672 Cabinet w/ 2 Wire Plug (fan only, use with existing metal housing)	
TF-MC133-02	(133mm) Heat Exchanger for Mesa 768 Cabinet w/ 3 Pin Plug	1355448
TF-MC133-05	(133mm) Heat Exchanger for Mesa Sport Cabinet w/ 3 Pin Bulkhead Plug	1482855
TF-CSHX133-01	(133mm) Heat Exchanger for Cell Site Mesa Sport w/ 4 Pin Male Weatherproof Plug	

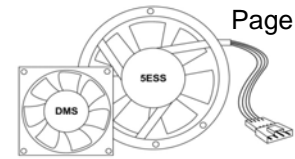

Part #	Description	MAT #
<b>OSP CABINET / TRAY FANS &amp; ALARM CONTROL BOARDS - continued from previous page</b>		
TF-MC133-01	(133mm) Heat Exchanger for Purcell FlexAir 741 (Door) w/ 4 Leads & Fastons	1358926
TF-MC175-04	(175mm) Heat Exchanger for Purcell A009 Cabinet w/ Weatherproof Connector	
TF-MC175-04-KIT	(175mm) Heat Exch. KIT for Purcell A009 Cabinet w/ Weatherproof Conn. & Bracket	
TF-SRA200-01	(175mm) Heat Exchanger for SRA-200 Cabinet w/ 3 Wire Plug (fan only)	1492655
TF-MC175-02	(175mm) Heat Exchanger for Mesa 4 NXT Cabinet (for Siemens ICN 087-23500-10)	1358925
TF-MC175-03	(175mm) Heat Exchanger for OSP Cabinet w/ 3 Pin Plug	1358924
TF-MC175-03W	(175mm) HX for Tellabs 1000 w/ 3 Leads	1458675
TF-MC175-01	(175mm) Heat Exchanger for Siemens 914EX Metro MXU Cabinet	1467133
TF-914EHX-01	48V HX for Siemens 914E RT Cbnt w/ Pwr Prongs	
TF-914EXMET-01	48V Fan for Siemens 914EX Metro MXU Fan Tray w/ Power Prongs	1359017
TF-OPTI-01	12V Fan for Opti 6100 Fan Trays w/ 3 Wire Plug (use in EFANM Fan Tray # 1184508L2)	1444322
TF-TA5KHX-02	48V "Low Profile" Heat Exchanger for Adtran TA5000 Cabinet Door w/ 4 Wire Plug	1501884
TF-HX220LP-01	(220mm) "Low Profile" HX for Calix ODC-1000 w/ 4 Leads & Fastons	1477798
TF-HX175LP-01	(175mm) "Low Profile" HX for Calix ODC Cabinet Door	1452035
TF-OPM640HX	(175mm) "Low Profile" Impeller for OPM 640 Cbnt (Retro Fit Roof) w/ 3 Wire, 4 Pin Plug	1492516
TF-AFCHX-01	(175mm) "Low Profile" Heat Exchanger for AFC Fan Unit found in OPM Cabinets	1475725
TF-CATNHX-01	(175mm) "Low Profile" Heat Exchanger for Catena Cabinet	
TF-MC179-01A	HX for Mesa Bridge Cabinet (Upper - Internal) w/ 4 Wire Female Weatherproof Plug	1490468
TF-MC179-01	HX for Mesa Bridge Cabinet (Lower - Door) w/ 4 Wire Female Weatherproof Plug	
TF-CQ250-01	(250mm) HX for Ice Qube Cabinet w/ 4 Wire Open End	
TF-AFC672-01	48V Fan for AFC Cabinet Heat Stack w/ Power Prongs	1456851
TF-CLXODC-01F	48V Heat Exchanger for Calix ODC Stack w/ 2 Wires & Fastons	1456478
TFC-CALIX2KHX	Alarm Control Board for Calix ODC-2000 Cabinet HX Controller (alarm board only)	1481590
TF-CLX225-02	(225mm) HX Impeller Fan (Upper) for Calix ODC Cabinet w/ 4 Wire Female Plug (30")	1492772
TF-CLX225-03	(225mm) HX Impeller Fan (Lower) for Calix ODC Cabinet w/ 4 Wire Male Plug (30")	1492619
TF-CLX133-01	(133mm) HX Impeller Fan (Upper/Lower) for Calix Cabinet w/ 4 Wire Plug	1490163
TF-MCCHX-AC01	110VAC HX Blower for Reltec / McLean Cabinet w/ Pwr Plug & Adapter Plate (fan only)	1481410
TF-MCCHX-AC0R	110VAC (Right)HX Blower for Reltec/McLean Cbnt w/ Pwr Plug & Adapt Plate (fan only)	1493505
TF-TX33HX-01	(175mm) HX for Mclean ClimaGuard Cabinet Cooler w/ 4 Wire Weatherproof Conn.	1473428
TF-TX38HX-01	(225mm) HX for Mclean ClimaGuard Cabinet Cooler w/ 4 Wire Weatherproof Conn.	1473110
TF-NP0402-01	48V Heat Exch. for Noren Cooling Unit - Internal (6.71K) w/ 3 Wire Open End	1359090
TF-NP0414-02	48V Heat Exch. for Noren Cooling Unit - External (8.45K) w/ 3 Wire Open End	1359019
TF-MC225-01	(225mm) Heat Exchanger for Mesa Cabinet (Top) w/ Round Weatherproof Connector	1345222
TF-MC225-02	(225mm) Heat Exchanger for Mesa Cabinet (Bottom) w/ 4 Wire Plug (fan only)	1345223
TF-MC225-02-KIT	(225mm) Heat Exchanger KIT for Mesa Cabinet (Bottom) w/ 4 Wire Plug & Bracket	1451725
TFB-MC225-02	Mounting Bracket & Hardware for Mesa Cabinet 225mm Bottom Heat Exchanger	1451078
TFC-MESA-01	2 Port Mesa Cabinet ECU (Cell Site: XL, SOLE, Span XL, Bridge, Edge & Sport)	
<b>CENTURYLINK FAN TRAY REPAIR – SAP CODES FOR ERT PROCESSING</b>		
<i>TAG refurbishes fan trays with NEW replacement parts that match the form, fit &amp; function of original equipment manufacturer</i>		
Part #	Description	SAP #
TFR-ALC1000-01	FAN TRAY REPAIR, Alcatel Fan Tray Assembly (3EC 15478)	1025443
TFR-SLCAPW-01	FAN TRAY REPAIR, Reltec/McLean SLC APW Fan Tray (UJB17H48S22)	1062881
TFR-LU2A-01	FAN TRAY REPAIR, Lucent 2A Fan Unit (T1AYAA)	1451702
TFR-LU2B-01	FAN TRAY REPAIR, Lucent 2B Fan Unit (COMCODE: 105550420)	1201093
TFR-NXTLEV-01	FAN TRAY REPAIR, Next Level (T03MC 039167)	1136989
TFR-F2876A-01	FAN TRAY REPAIR, NEC (F2876A)	1025443
TFR-UMC1000-06	FAN TRAY REPAIR, Tellabs UMC1000, (6 fan) (AFC Tray # 0310-1716 or 8650-0414)	CALL
TFR-UMC1000-08	FAN TRAY REPAIR, Tellabs UMC1000, (8 fan) (Tellabs Tray # 4195091)	CALL
TFR-UMC1000-10	FAN TRAY REPAIR, Tellabs UMC1000, (10 fan) (AFC Tray F10 # 0310-1716)	CALL
TFR-NXWDL-01	FAN TRAY REPAIR, TAG Universal 19/23" Cabinet Fan Tray	1451023
TFR-NXWDL-02	FAN TRAY REPAIR, TAG Universal 19/23" "Harsh Environment" Cabinet Fan Tray	1472248
TFR-LU2C-01	FAN TRAY REPAIR, Lucent 2C Fan Unit (COMCODE: 106382336 / 109198341)	1088888
TFR-LU4A-01	FAN TRAY REPAIR, Lucent 4A Fan Unit (COMCODE: 106526742)	1237468
TFR-LU4B-01	FAN TRAY REPAIR, Lucent 4B Fan Unit (COMCODE: 106527005)	1201094
TFR-114A-01	FAN TRAY REPAIR, 114A Fan Control Unit (COMCODE: 106894934)	1134261
TFR-LS2000-02	FAN TRAY REPAIR, Litespan 2000 HV PDFA Fan Tray (509-0000-086)	1164081
TFR-LS2000-44	FAN TRAY REPAIR, Litespan 2000 DFA Fan Tray (500-1100-400)	1006831

**Don't see the fan you are looking for? Send us a sample & we will find a match!**

**PLEASE CALL: 856-753-8585 or EMAIL: [custsvcs@tagcords.com](mailto:custsvcs@tagcords.com)**

# 5ESS "Pre-Charge" Tool

# T-5ESSPCT

5ESS Fuse Bay Control Panel,  
Lucent # ED-83024-30

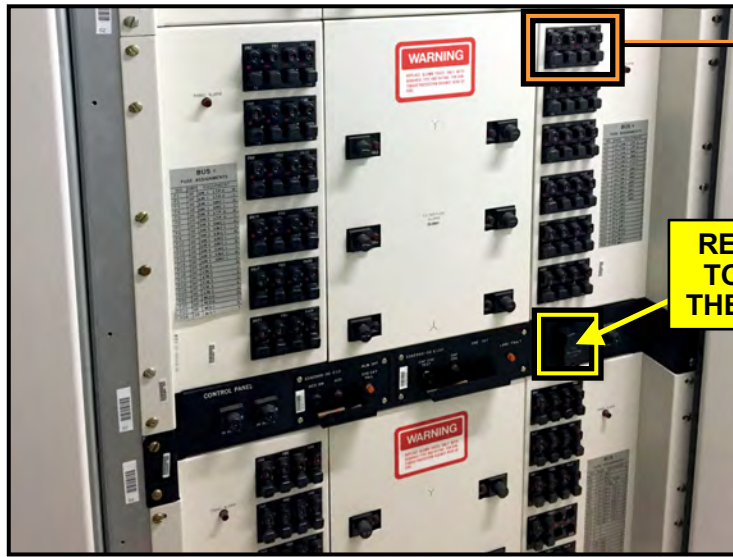

**REPLACES BROKEN  
TOOL LOCATED ON  
THE CONTROL PANEL**

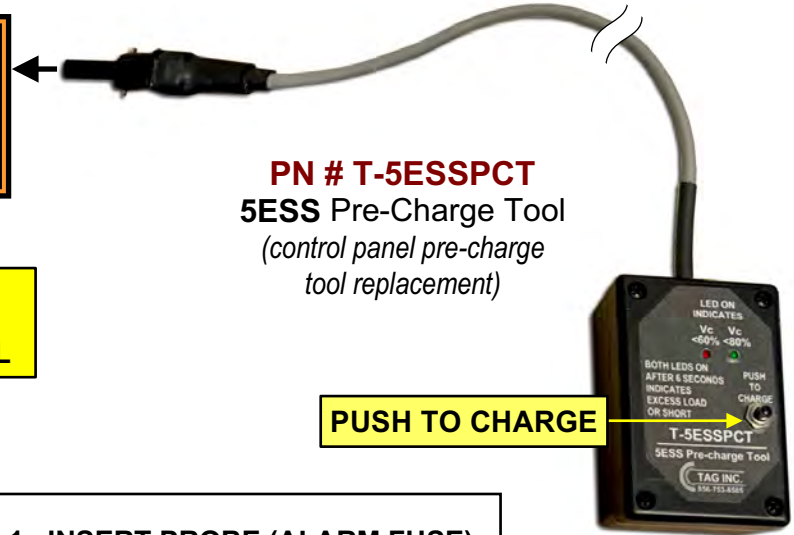

**PN # T-5ESSPCT**  
5ESS Pre-Charge Tool  
(control panel pre-charge  
tool replacement)

**PUSH TO CHARGE**

1. INSERT PROBE (ALARM FUSE)
2. PRESS TEST BUTTON
3. RED & GRN LEDS WILL LIGHT
4. 4-6 SEC LEDS WILL GO OUT
5. INSTALL MAIN FUSE
6. IF RED LED STAYS ON EXCESS LOAD OR SHORT IS PRESENT

### Application:

TAG's PN # T-5ESSPCT is used to pre-charge shelf power capacitors of a 5ESS switch. This allows a new fuse to be installed without seeing full in-rush surge current. The indicator light goes out when it is safe to install the fuse.

<b>Ordering Information:</b>		<b><u>Lumen/CLK MAT #</u></b>
<b>T-5ESSPCT</b>	<b>5ESS "Pre-Charge" Tool for Capacitor Charging at Main Fuse Bay</b> <i>(control panel pre-charge tool replacement)</i>	<b>1496454</b>

150 Cooper Rd. (F-15)  
W. Berlin, NJ 08091

[www.tagcords.com](http://www.tagcords.com)  
**Telecom Assistance Group**

Telephone: (856) 753-8585  
Fax: (856) 768-7645

# TAG DMS-100 3X9013 Universal Fan Tray

# TFT-3X9013T

## Universal 48VDC Fan Tray

- **No 24VAC Inverters**  
*(24VAC inverters cause heat concerns & major equipment failures)*
- **No Mechanical Sensors**  
*(sensor paddles are known to bend & break)*

### INSTALLATION VIDEOS:



NT3X90AA/AB



NT3X90AC



NT3X90AF

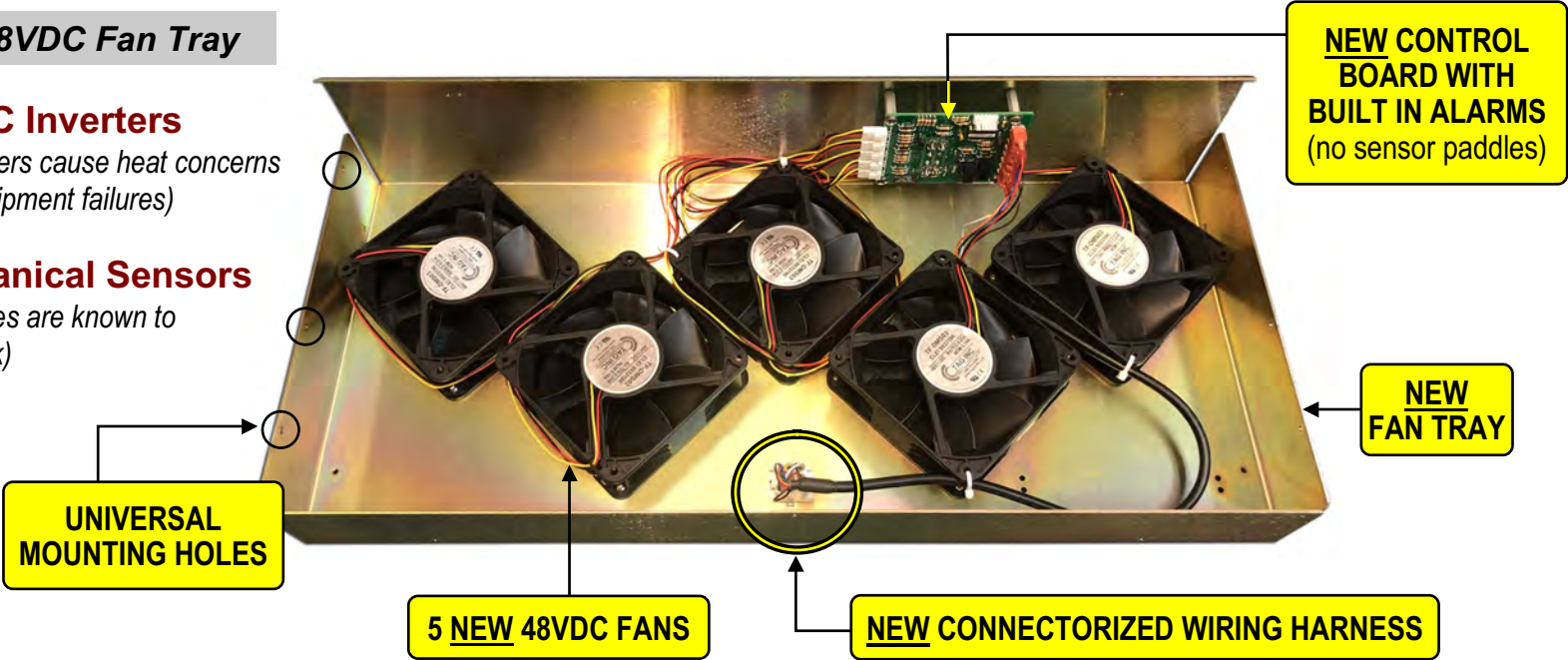

- Connectorized Universal metal tray with Fan Alarm Board *(no sensor paddles)*
- Pre-assembled & works with NT3X90AA, NT3X90AB, NT3X90AC & NT3X90AF Cooling Units
- Adapter cables\* are supplied for NT3X90AA/AB & NT3X90AF Cooling Units  
*\*(adapter cables are not used with NT3X90AC)*

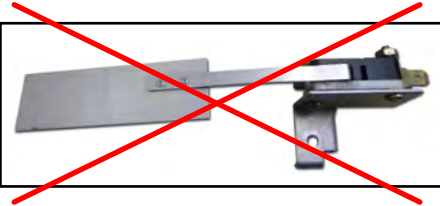

### Ordering Information:

TFT-3X9013T

**TAG Universal DMS-100 3X9013 Fan Tray**

Includes: (1) Brand New Fan Tray w/ Universal Mounting Holes,  
 (5) TF-DMS03, 48VDC Fans w/ TTL Tach & 3 Wire Plug,  
 (1) Fan Control Board w/ Built in Sensors (no paddles needed), Wiring Labels, Mounting Hardware,  
 (1) Wiring Harness w/ Connector, NT3X90AA/AB & NT3X90AF Adapter Cables & Installation Guide

Lumen/CLK MAT #

1492217

150 Cooper Rd. (F-15)  
 W. Berlin, NJ 08091

www.tagcords.com  
**Telecom Assistance Group**

Telephone: (856) 753-8585  
 Fax: (856) 768-7645