

Frontier 2025 Product Ordering Guide

[Issue 1.0](#)

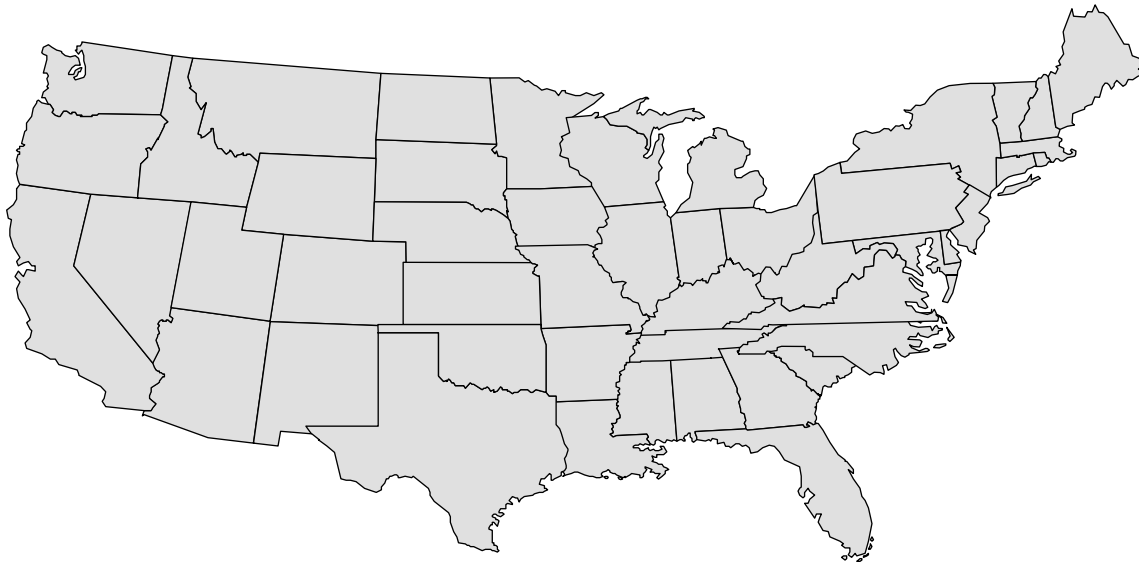

Provided By:



TAG INC.

Telecom Assistance Group, Inc.
856-753-8585
www.tagcords.com

The "Cord Company" and more . . .

"TEST CORDS & ADAPTERS"



"T1 REPEATERS & EXTENDERS"

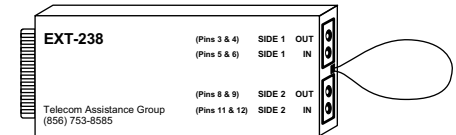

"FIBER OPTIC CORDS, COUPLERS & STREAKERS"



"DUMB TERMINALS"



"FANS"

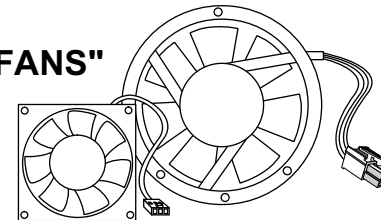







"NEBS CERTIFIED SOLID STATE SCSI DRIVES"

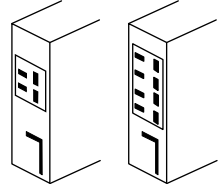
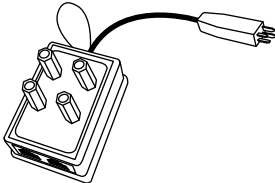
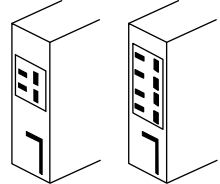
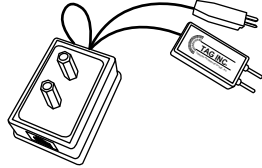
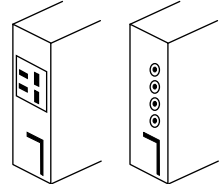
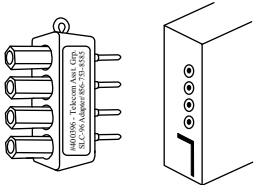
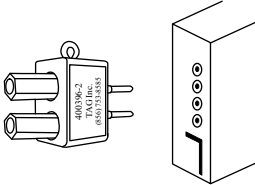
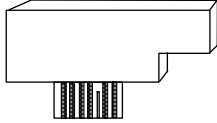





www.tagcords.com





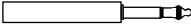
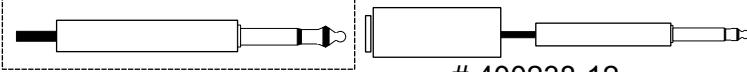

-

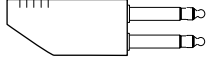
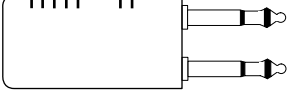

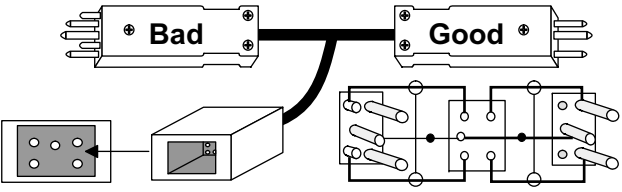

856-753-8585





FEATURES / APPLICATION	FTR UPN #	DESCRIPTION
<p>SLC Series 5 Test Cord, (1')</p> <ul style="list-style-type: none"> Dial tone access at faceplate of Series 5 or SLC 2000 	<p>400395-2</p>	<p>SLC SERIES 5 TEST CORD</p>   <p>Series 5 SLC 2000</p>
<p>SLC Series 5 Test Cord, (3')</p> <ul style="list-style-type: none"> Hollow post (Alligator Clip access) and/or modular (RJ11) access to Odd/Even channels Dial tone access at faceplate of Series 5 or SLC 2000 	<p>400395</p>	<p>SLC SERIES 5 TEST CORD</p>   <p>Series 5 SLC 2000</p>
<p>"The SLICK CORD", (2')</p> <ul style="list-style-type: none"> Dual Purpose cord for Series 5 / SLC 2000 and / or SLC-96 / DISC*S faceplate access 	<p>4003956</p>	<p>"SLICK CORD"</p>   <p>Series 5 SLC-96</p>
<p>SLC-96 Line Adapter <u>FTR UPN #</u> 400396</p> <ul style="list-style-type: none"> Hollow post access to Odd/Even Channels at faceplate of SLC-96/DISC*S channel units  <p>SLC-96</p>	<p>SLC-96 Line Adapter <u>FTR UPN #</u> 400396-2</p> <ul style="list-style-type: none"> Hollow post access to Odd/Even Channels at faceplate of SLC-96/DISC*S channel units  <p>SLC-96</p>	<p>SLC-96 Looping Plug <u>FTR UPN #</u> 400396L</p> <p>SLC-96 Looping Plug (2-Way) <u>FTR UPN #</u> 400396LD</p> <ul style="list-style-type: none"> Loops SLC-96 circuits at the LIU 

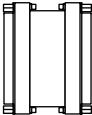
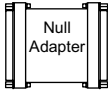
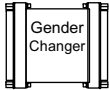
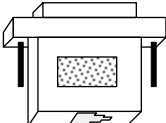

FEATURES / APPLICATION	FTR UPN #	DESCRIPTION
<p>Bantam to Bantam - Black, (3')</p> <p>Bantam to Bantam, (6')</p> <p>Bantam to Bantam - Black, (8')</p> <p>Bantam to Bantam - Red, (8')</p> <p>Bantam to Bantam, (20')</p> <ul style="list-style-type: none"> • General purpose test / patch cord 	<p>400210BK-03</p> <p>400210</p> <p>400210BK-08</p> <p>400210RD-08</p> <p>400210-20</p>	<p>BANTAM to BANTAM</p> 
<p>Dual Bantam to Dual Bantam, (25')</p> <p>Dual Bantam to Dual Bantam, (30')</p> <ul style="list-style-type: none"> • General purpose test / patch cord 	<p>400210DD-25</p> <p>400210DD-30</p>	<p>DUAL BANTAM to DUAL BANTAM</p> 
<p>Bantam to (2) Alligator Clips, (6')</p> <p>Bantam to (2) Alligator Clips, (8')</p> <p>Bantam to (2) Alligator Clips - Red, (8')</p> <ul style="list-style-type: none"> • Access to various connectors, bare cable 	<p>400210A</p> <p>400210A-08</p> <p>400210ARD-08</p>	<p>BANTAM to ALLIGATOR CLIPS</p> 
<p>Bantam to Wire Wraps, (6')</p> <ul style="list-style-type: none"> • Slides on standard CO terminal block pins (.045) for test access 	<p>400210WP</p>	<p>BANTAM to WIRE WRAP TERMINALS</p> 
<p>Bantam to Protector - Black, (8')</p> <p>Bantam to Protector - Red, (8')</p> <ul style="list-style-type: none"> • Wired Tip & Ring to long Pins • No ground pin allows to flip and test both ways 	<p>400210SBK-08</p> <p>400210SRD-08</p>	<p>BANTAM to PROTECTOR</p> 
<p>Bantam to 310, (12')</p> <p>Bantam to 310, (20')</p> <p>Bantam to 310, (25')</p> <p>Bantam to 310, (40')</p> <p>Bantam to 310, Blue, (25')</p> <p>Bantam to 310, Red, (25')</p> <ul style="list-style-type: none"> • General purpose test / patch cord 	<p>400310M-12</p> <p>400310M-20</p> <p>400310M-25</p> <p>400310M-40</p> <p>400310MBL-25</p> <p>400310MRD-25</p>	<p>BANTAM to 310</p> 



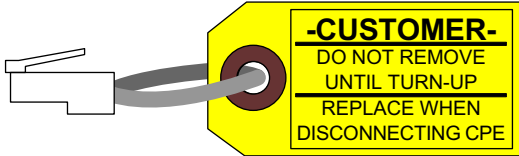
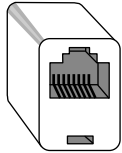
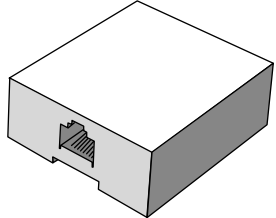

FEATURES / APPLICATION	FTR UPN #	DESCRIPTION			
310 to 310, (6') <ul style="list-style-type: none"> General purpose test / patch cord 	400310	310 to 310 			
310 to (2) Alligator Clips, (6') <ul style="list-style-type: none"> Access to various connectors, bare cable 	400310A	310 to ALLIGATOR CLIPS 			
310 to Wire Wrap Terminals, (6') <ul style="list-style-type: none"> Slides on standard terminal block pins (.045) for test access 	400310WP	310 to WIRE WRAP TERMINALS 			
Bantam to 310 Conversion Plug Bantam to 310 Conversion Plug, Red <ul style="list-style-type: none"> Slides over bantam plug converting it to a 310 	400239BST 400239RD	BANTAM TO 310 CONVERSION PLUG  <div style="display: flex; justify-content: space-around; margin-top: 5px;"> BANTAM <div style="text-align: center;">  # 400239BST # 400239RD (RED) </div> </div>			
310 (female) to Bantam Conversion Cord, (12") <ul style="list-style-type: none"> 310 Plugs into adapter converting to bantam 	400238-12	310 to BANTAM CONVERSION CORD  <div style="display: flex; justify-content: space-around; margin-top: 5px;"> 310 # 400238-12 </div>			
Bantam Terminating Plug 310 Terminating Plug <ul style="list-style-type: none"> 100 ohm <div style="display: flex; justify-content: space-around; margin-top: 10px;"> <div style="text-align: center;">  # 400210TP-1 </div> <div style="text-align: center;">  # 400310TP-1 </div> </div>	<u>FTR UPN #</u> 400210TP-1 400310TP-1	Bantam Looping Plug <ul style="list-style-type: none"> 3 conductor looping plug 	<u>FTR UPN #</u> 400210LP	310 Looping Plug <ul style="list-style-type: none"> 3 conductor looping plug 	<u>FTR UPN #</u> 400310LP

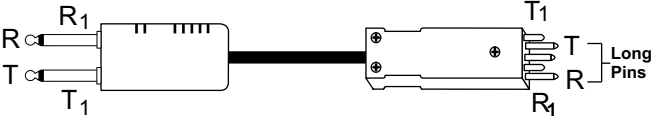

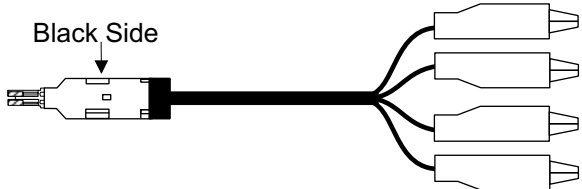
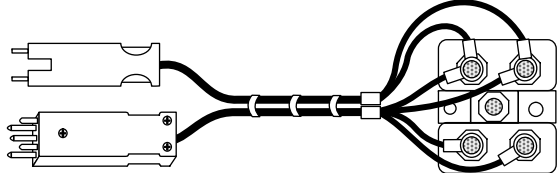

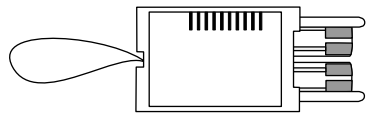
FEATURES / APPLICATION	FTR UPN #	DESCRIPTION
<p>Protector to Protector "Frogger" with "In-Line Protection", (20')</p> <ul style="list-style-type: none"> Frogger with In-Line Protection Ideal for quick temporary restoral with "protection" 	<p>400300FP</p>	<p>FROGGER W/ IN-LINE PROTECTION</p> 
<p>Protector (non-bridging) to Alligator Clips, (8') Protector (non-bridging) to Alligator Clips, (3')</p> <ul style="list-style-type: none"> Test access at coils 	<p>400300S 400300S-03</p>	<p>PROTECTOR to ALLIGATOR CLIPS</p> 
<p>Protector to Alligator Clips, (3')</p> <ul style="list-style-type: none"> Test access at MDF (coils) 	<p>400300C-3</p>	<p>PROTECTOR to ALLIGATOR CLIPS</p> 
<p>Protector (non-bridging) to Alligator Clips, (3')</p> <ul style="list-style-type: none"> Test access at Porta Frame (coils) 	<p>400300SP-03</p>	<p>PORTA to ALLIGATOR CLIPS</p> 
<p>Dual Push Pins (310 MDF) to Alligator Clips, (3')</p> <ul style="list-style-type: none"> Used to short the tip and ring or to ground the tip and/or ring Plugs to recessed terminals on 310 series connectors Equivalent to P2FM 	<p>400426</p>	<p>DUAL PUSH PINS to ALLIGATOR CLIPS</p> 
<p>RJ11 to Wire Wraps, (6')</p> <ul style="list-style-type: none"> Can be used as a xDSL / Caller ID test cord 	<p>400100WP</p>	<p>RJ11 to WIRE WRAP TERMINALS</p> 



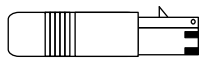

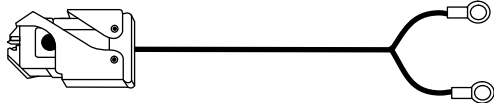

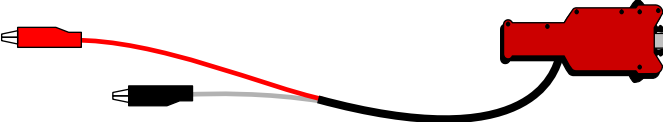
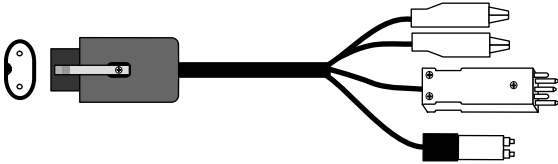
FEATURES / APPLICATION		FTR UPN #	DESCRIPTION
DB 9 Pin (male) to DB 9 Pin (female), (6') DB 9 Pin (male) to DB 9 Pin (female), (8') <ul style="list-style-type: none"> • Commonly used from Laptop to test at Pair Gain (HDSL) • Wired straight 		400720 400720-08	9 PIN (male) to 9 PIN (female) 
DB 9 Pin (female) to DB 9 Pin (female) - Null, (6') <ul style="list-style-type: none"> • Commonly used from Laptop to test at craft access ports with null wiring 		400720FN	9 PIN (female) to 9 PIN (female) - NULL 
DB 9 Pin (female) to DB 25 Pin (male), (6') DB 9 Pin (female) to DB 25 Pin (male), (10') DB 9 Pin (female) to DB 25 Pin (male), (25') <ul style="list-style-type: none"> • IBM AT COM1 Computer Cable 		400703-06 400703L 400703-25	9 PIN (female) to 25 PIN (male) 
DB 25 Pin (male) to DB 25 Pin (male), (50') <ul style="list-style-type: none"> • Standard Serial Printer Cable, (25 Wires) 		400705-50	25 PIN (male) to 25 PIN (male) 
 <p>FTR UPN # 400701 DB 25 Pin (male) to (male) Gender Changer</p>	 <p>FTR UPN # 400709N DB 9 Pin (male) to (female) "Null Adapter"</p>	 <p>FTR UPN # 400709S DB 9 Pin (female) to (female) Adapter Gender Changer</p>	 <p>FTR UPN # 400710 DB 25 Pin (male) to RJ45 Adapter</p>





FEATURES / APPLICATION	FTR UPN #	DESCRIPTION
<p>9 Pin D (female) to RJ45, (6')</p> <ul style="list-style-type: none"> Used from Laptop (9 pin male on Laptop) to Catena Network ADSL card (RJ45 jack on card) 	<p>400722ADSL</p>	<p>9 PIN D (female) to RJ45</p> 
<p>Bantam "Y" (Tx & Rx) to RJ48C- (T1), (8')</p> <ul style="list-style-type: none"> Commonly used to Transmit (TX) and Receive (RX) from T1 tests The RJ48C plugs into the faceplate of T1 cards allowing test access 	<p>400248</p>	<p>BANTAM "Y" to RJ48C, (8')</p> 
<p>RJ48 (T1) to 4 Alligator Clips, (6')</p> <ul style="list-style-type: none"> 597243 Alligator Clip Access to RJ48 (Pins 1,2,4,5) 	<p>400448A4-06</p>	<p>RJ48 (T1) to 4 ALLIGATOR CLIPS, (6')</p> 
<p>RJ45 to 6A Alligator Clips, (6')</p> <ul style="list-style-type: none"> General Purpose Test Cord - ISDN (Tip - Pin 5, Ring - Pin 4) 	<p>400448A2</p>	<p>RJ45 to 6A ALLIGATOR CLIPS</p> 
 <p>FTR UPN # 400448LP Temporary RJ48 Looping Plug</p> <ul style="list-style-type: none"> Used to loop "Smart Jack" to provide a physical loop 	 <p>FTR UPN # RJ48-C RJ48 Coupler</p> <ul style="list-style-type: none"> General purpose adapter 	 <p>FTR UPN # RH-RJ48FMB RJ48 Female Mounting Block</p> <ul style="list-style-type: none"> General purpose adapter



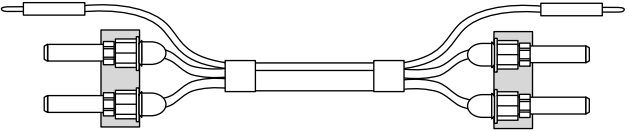
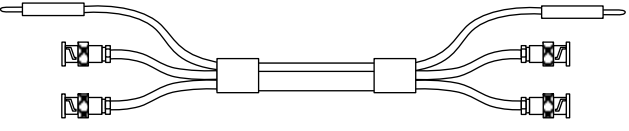

FEATURES / APPLICATION	FTR UPN #	DESCRIPTION
<p>Mini Test Clip to Mini Test Clip, (3') - RED Mini Test Clip to Mini Test Clip, (3') - BLACK</p> <ul style="list-style-type: none"> • General purpose cord 	<p>400400TR-03 400400TB-03</p>	<p>MINI TEST CLIP to MINI TEST CLIP</p> 
<p>Dual 310 (327) plug to Protector, (16')</p> <ul style="list-style-type: none"> • Used to make In/Out tests from 302/308 type connectors • Equivalent to W4BR 	<p>T-W4BR-16</p>	<p>DUAL 310 (327) to PROTECTOR</p> 
<p>Protector to Alligator Clips, (3')</p> <ul style="list-style-type: none"> • 463 type plug (protector) to alligator clips • Equivalent to W2GL 	<p>T-W2GL</p>	<p>PROTECTOR to ALLIGATOR CLIPS</p> 
<p>Krone (non-bridging) to (4) Alligator Clips, (3')</p> <ul style="list-style-type: none"> • Access to Krone connector blocks to test Central Office Equipment (COE) and/or Customer Premise Equipment (CPE) 	<p>400300K4A</p>	<p>KRONE (non-bridging) to (4) ALLIGATOR CLIPS</p> 
<p>Protector/526A plug to 125 Station Protector, (10')</p> <ul style="list-style-type: none"> • Cabinet mounting assembly for performing line tests on SLC-96 & Series 5 	<p>T-6W3F-10</p>	<p>PROTECTOR/526A to STATION PROTECTOR</p> 

FEATURES / APPLICATION	FTR UPN #	DESCRIPTION
<p>800 DSX Looping Plug 800 DSX Looping Plug</p> <ul style="list-style-type: none"> # 408800LP "Loops" in ONE Direction # 408800LD "Loops" in BOTH Directions 	<p>408800LP 408800LD</p>	<p>800 DSX LOOPING PLUG</p> 
<p>Bantam "Y" to 800 Duplex (White Cord), (12') Bantam "Y" to 800 Duplex (Blue Cord), (6') Bantam "Y" to 800 Duplex (Orange Cord), (8') Bantam "Y" to 800 Duplex (Orange Cord), (8')</p> <ul style="list-style-type: none"> "WHITE CORD" establishes a "Near-Side" connect (Disconnects "Far-Side") "BLUE CORD" establishes a "Far-Side" connect (Disconnects "Near-Side") "ORANGE CORD" monitors both directions 	<p>408801-12 (white) 408803 (blue) 408805-08 (orange) 4008805-12 (orange)</p>	<p>BANTAM "Y" to 800 DUPLEX</p> 
<p>800 DSX to 800 DSX, (12')</p> <ul style="list-style-type: none"> 800 DSX Patch Cord 	<p>408800-12</p>	<p>800 DSX to 800 DSX</p> 
<p>Bantam to 800 DSX, (6') Bantam to 800 DSX, (25')</p> <ul style="list-style-type: none"> Test equipment access to 800 DSX 	<p>408210 408210-25</p>	<p>BANTAM to 800 DSX</p> 
<p>310 to 800 DSX, (6')</p> <ul style="list-style-type: none"> Test equipment access to 800 DSX 	<p>408310</p>	<p>310 to 800 DSX</p> 
<p>800 DSX Terminating Plug</p> <ul style="list-style-type: none"> 100 ohm Terminating Plug 	<p>408800TP-1</p>	<p>800 DSX TERMINATING PLUG</p> 

FEATURES / APPLICATION	FTR UPN #	DESCRIPTION
<p>D Clip to Round Lugs, (4')</p> <ul style="list-style-type: none"> Used from various test sets at 88, 110 type connectors 	<p>400110SL</p>	<p>D CLIP to ROUND LUGS</p> 
<p>76 Clip to Round Lugs, (4')</p> <ul style="list-style-type: none"> Used from various test sets at 76 type connectors 	<p>400276RL</p>	<p>76 CLIP to ROUND LUGS</p> 
<p>Nortel BIX Block Test Cord</p> <ul style="list-style-type: none"> Single-pair probe that clips onto the termination clip of BIX Distribution or Modular Jack Connectors for testing 	<p>T-QTBIX17A</p>	<p>NORTEL BIX BLOCK TEST CORD</p> 
 <p>FTR UPN # 2-ADE-05 471 Jack to Alligator Clips, 463A Protector / 453A, (5')</p> <ul style="list-style-type: none"> Use with 346 plug Butt-Sets 	 <p>FTR UPN # 1-O-06 Hardwire to 6P Alligator Clips, (6')</p> <ul style="list-style-type: none"> Use with Standard Non-Weatherproof Butt-Sets 	 <p>FTR UPN # 1-ACEF-6 Hardwire to Alligator Clips, Wire Wraps / 453A / Bantam, (6')</p> <ul style="list-style-type: none"> Use with Standard Non-Weatherproof Butt-Sets

FEATURES / APPLICATION	FTR UPN #	DESCRIPTION
<p>440A (male) to 440A (male) Loopback Cord, (8")</p> <ul style="list-style-type: none"> Allows a technician to verify the patch cord portion of a DS3 circuit under test 	<p>400440A-R8</p>	<p>440A (male) LOOPBACK CORD</p> 
<p>440D Loopback Plug (molded)</p> <ul style="list-style-type: none"> 440D Loopback plug 	<p>400440DLM</p>	<p>440D LOOPBACK PLUG (molded)</p> 
<p>440 (female) to 440 (female) Loopback Cord, (8")</p> <ul style="list-style-type: none"> Allows a technician to verify the patch cord portion of a DS3 circuit under test 	<p>400440FLP-01</p>	<p>440 (female) LOOPBACK CORD</p> 
<p>440 (female) to 440 (female) Loopback Tool</p> <ul style="list-style-type: none"> Allows a technician to verify the patch cord portion of a DS3 circuit under test 	<p>400440LPT</p>	<p>440 (female) LOOPBACK TOOL</p> 
<p>BNC (female) to BNC (female) Loopback Tool</p> <ul style="list-style-type: none"> Allows a technician to verify the patch cord portion of a DS3 circuit under test 	<p>400600LPT</p>	<p>BNC (female) LOOPBACK TOOL</p> 
<p>Mini-SMB Coax Loopback Tool (female / male)</p> <ul style="list-style-type: none"> Used to verify Mini-SMB coax cabling when extending FITL equipment 	<p>400632LPT</p>	<p>MINI-SMB COAX LOOPBACK TOOL</p> 

FEATURES / APPLICATION	FTR UPN #	DESCRIPTION
<p>Dual 440D to Dual 440D w/ Tracer, (5')</p> <ul style="list-style-type: none"> A convenient way of patching Tx & Rx circuits at the same time 	<p>400440DD-05</p>	<p>DUAL 440D to DUAL 440D w/ TRACER</p> 
<p>Dual BNC to Dual BNC w/ Tracer, (3') Dual BNC to Dual BNC w/ Tracer, (9') Dual BNC to Dual BNC w/ Tracer, (35') Dual BNC to Dual BNC w/ Tracer, (45')</p> <ul style="list-style-type: none"> Patch cord used with DSX-3/4 	<p>400440BB-03 400440BB-09 400440BB-35 400440BB-45</p>	<p>DUAL BNC to DUAL BNC w/ TRACER</p> 
<p>440A to BNC - Red, (8') 440A to BNC - Red, (14') 440A to BNC - Blue, (14')</p> <ul style="list-style-type: none"> Coax Patch/Test Cord 	<p>400440BRD-08 400440BRD-14 400440BBL-14</p>	<p>440A to BNC</p> 
<p>440A to 440A, (9'') 440A to 440A - Black, (8') 440A to 440A, (15')</p> <ul style="list-style-type: none"> Coax Patch/Test Cord 	<p>400440A-01 400440ABK-08 400440A-15</p>	<p>440A to 440A</p> 
<p>440A to 358A - Black, (8') 440A to 358A - Red, (8') 440A to 358A, (15')</p> <ul style="list-style-type: none"> Coax Patch/Test Cord 	<p>440358ABK-08 440358ARD-08 440358A-15</p>	<p>440A to 358A</p> 
<p>358A to 358A, (9'')</p> <ul style="list-style-type: none"> Coax Patch/Test Cord 	<p>400358A-01</p>	<p>358A to 358A</p> 

FEATURES / APPLICATION	FTR UPN #	DESCRIPTION
<p>Dual Plug (327) to 412A/B, (16')</p> <ul style="list-style-type: none"> • Frame Cord - used from jack panels to protector on Vertical side of MDF 	<p>T-4W11A-16</p>	<p>FRAME CORD, 412A/B - RED</p> 
<p>Dual Plug (327) to 252A/B, (16')</p> <ul style="list-style-type: none"> • Frame Cord - used from jack panels to protector on Vertical side of MDF 	<p>T-4W6A-16</p>	<p>FRAME CORD, 252A/B - RED</p> 
<p>Dual Plug (327) to Porta, (16')</p> <ul style="list-style-type: none"> • Frame Cord - used from jack panels to protector on Vertical side of MDF 	<p>T-W4BR-P</p>	<p>FRAME CORD, PORTA - RED</p> 
<p>Dual 327C Plug to 463A, (20')</p> <ul style="list-style-type: none"> • Frame Cord - used from jack panels to protector on Vertical side of MDF 	<p>F44-CJ-20</p>	<p>FRAME CORD, 5 PIN - RED</p> 

T1 / DSL Test Cords

- JDSU Smart Class* xDSL

- Spirent Tech-X-Flex**

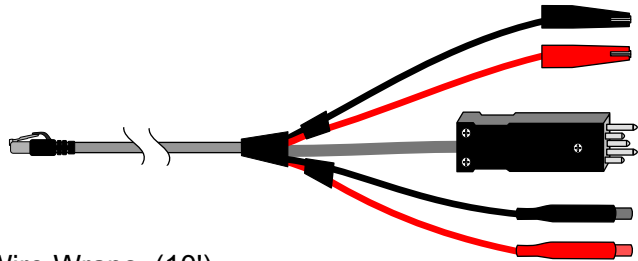

FTR UPN # 400253JSA

RJ11 (snagless) to Mini Alligator Clips / 463A / Wire Wraps, (10')

- Exfo 635

- Colt 250***

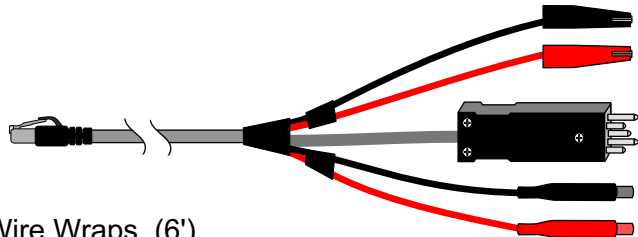

FTR UPN # 400250SB

RJ45 (snagless) to Mini Alligator Clips / 463A / Wire Wraps, (6')

- Exfo 635

- Colt 250

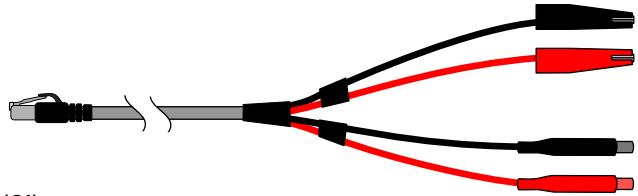

FTR UPN # 400250SV-08

RJ45 (snagless) to Alligator Clips / Wire Wraps, (8')

- Exfo 635

- Colt 250

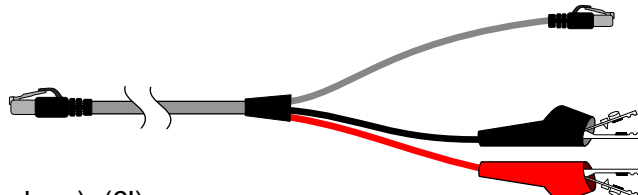

FTR UPN # 400250DSL

RJ45 (snagless) to 6P Alligator Clips / RJ11 (snagless), (6')

- Dynatel FED****

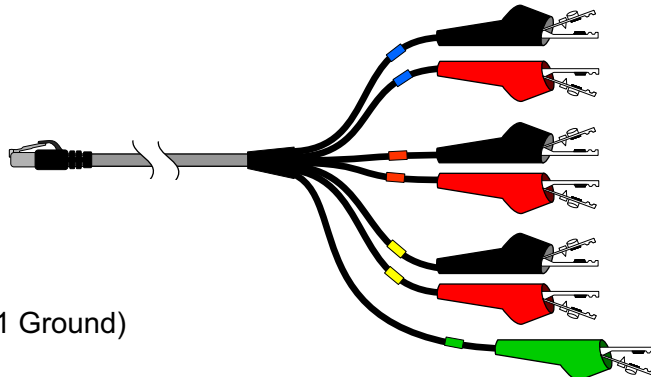

FTR UPN # 400251DSL7-6P

RJ45 (snagless) to (7) 6P Alligator Clips , (6')
(2 Blue / 2 Red / 2 Yellow / 1 Ground)

Copyright © 2023 by Telecom Assistance Group, Inc.

150 Cooper Rd. (F-15)
W. Berlin, NJ 08091

www.tagcords.com

Telephone: (856) 753-8585
Fax : (856) 768-7645

Telecom Assistance Group

* JDSU Smart Class is a registered Trademark.

**** Dynatel FED is a registered Trademark.

2023 Frontier ID\Master13ftr_r13.dsf (07/13/23)

** Spirent Tech-X-Flex is a registered Trademark.

***Colt 250 & Exfo 635 are registered trademarks of EXFO Electro-Optical Engineering Inc. All rights reserved.

JDSU HST-3000* Test Cords



FTR UPN #
ACT-4001006PRD
HST3000 to
6P Alligator Clips (Red), (6')

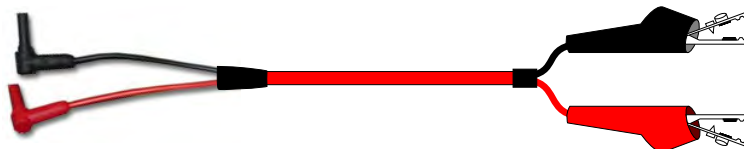

FTR UPN #
ACT-4001006PBY
HST3000 to
6P Alligator Clips (Blue), (6')



FTR UPN #
ACT-400409
Ground Cord, HST3000 to
Alligator Clip (Green), (8')



150 Cooper Rd. (F-15)
W. Berlin, NJ 08091

www.tagcords.com

Telephone: (856) 753-8585
Fax : (856) 768-7645

Telecom Assistance Group

JDSU ONX Test Cord Kit

KIT-JDSU-ONX



(1) # TCC-001P
8 Pouch Carrying Case

Test Cord Kit for use with JDSU ONX Test Set

-Individual items can also be ordered-

Provides a carrying case with all the
cords that a "Tech" needs in the field

(1) # ACT-4004096P
Ground Cord, Mini Banana to
6P Alligator Clip (Green), (8')

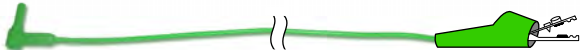

(1) # ACT-400100WPRD
Mini Bananas to Wire Wraps (Red), (6')

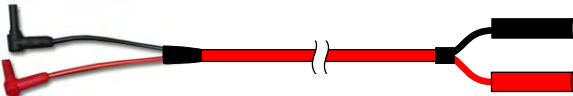

(1) # ACT-400100WPBY
Mini Bananas to Wire Wraps (Blue), (6')

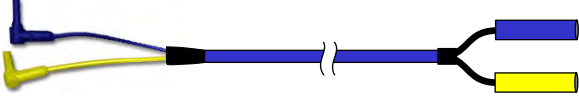

(1) # ACT-4001006PRD
Mini Bananas to 6P Alligator Clips (Red), (6')

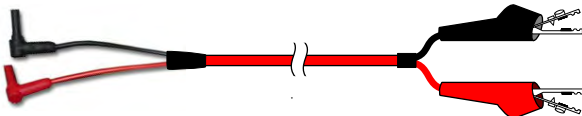

(1) # ACT-4001006PBY
Mini Bananas to 6P Alligator Clips (Blue), (6')

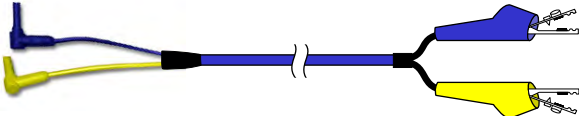

(1) # ACT-400100ARD
Mini Bananas to Alligator Clips (Red), (6')

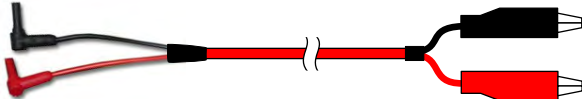

(1) # ACT-400100ABY
Mini Bananas to Alligator Clips (Blue), (6')

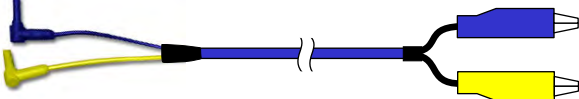

(1) # ACT-400148SBY
Mini Bananas to RJ48S - (DDS), (6')

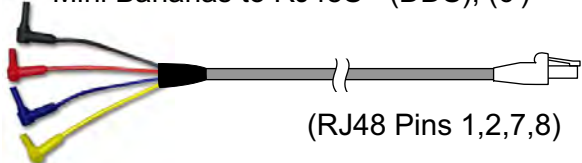

(1) # ACT-400148BY
Mini Bananas to RJ48C - (T1), (6')

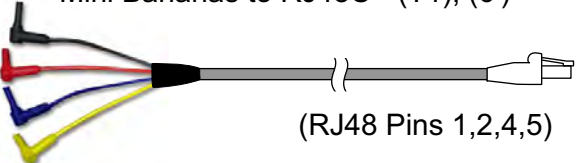

Ordering Information:

JDSU ONX Test Cord Kit

KIT FTR UPN #
KIT-JDSU-ONX

150 Cooper Rd. (F-15)
W. Berlin, NJ 08091

www.tagcords.com

Telephone: (856) 753-8585
Fax : (856) 768-7645

Telecom Assistance Group

Laptop Cord Kit

KIT-LAPVZKO

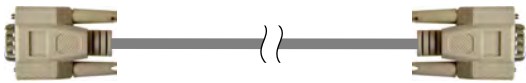

(1) # 400720MM
DB9M to DB9M, (10')



(1) # 400700
DB25F Gender Changer

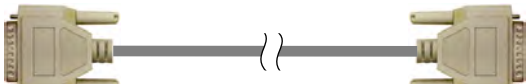

(1) # 400705
DB25M to DB25M, (6')



(1) # 400700N
DB25F Gender Changer (NULL)

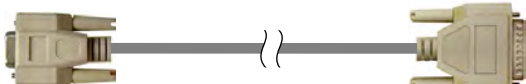

(1) # 400703
DB9F to DB25M, (6')



(1) # 400709S
DB9F Gender Changer

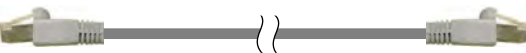

(1) # 400448-06
RJ48 to RJ48 Ethernet Cable, (6')



(1) # 400709FN
DB9F Gender Changer (NULL)

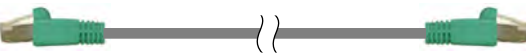

(1) # 400448XP
RJ48 to RJ48
Ethernet Crossover Cable, (10')



(1) # RJ48-C
RJ48 Coupler



(1) # 600209 Approx. Dimensions:
Carrying Case 5" (H) x 16" (L)



(1) # 400721USB
DB9M/RS232 to USB Adapter Cable
(includes driver software)

Ordering Information:

Laptop Cord Kit

includes: (1) 400720MM, (1) 400705, (1) 400703, (1) 400448-06, (1) 400448XP, (1) 400700, (1) 400700N, (1) 400709S, (1) 400709FN, (1) RJ48-C, (1) 400721USB & (1) 600209 - (carrying case)

FTR UPN #
KIT-LAPVZKO

150 Cooper Rd. (F-15)
W. Berlin, NJ 08091

www.tagcords.com

Telephone: (856) 753-8585
Fax : (856) 768-7645

Telecom Assistance Group

Business Class Network Interface Device (NID)

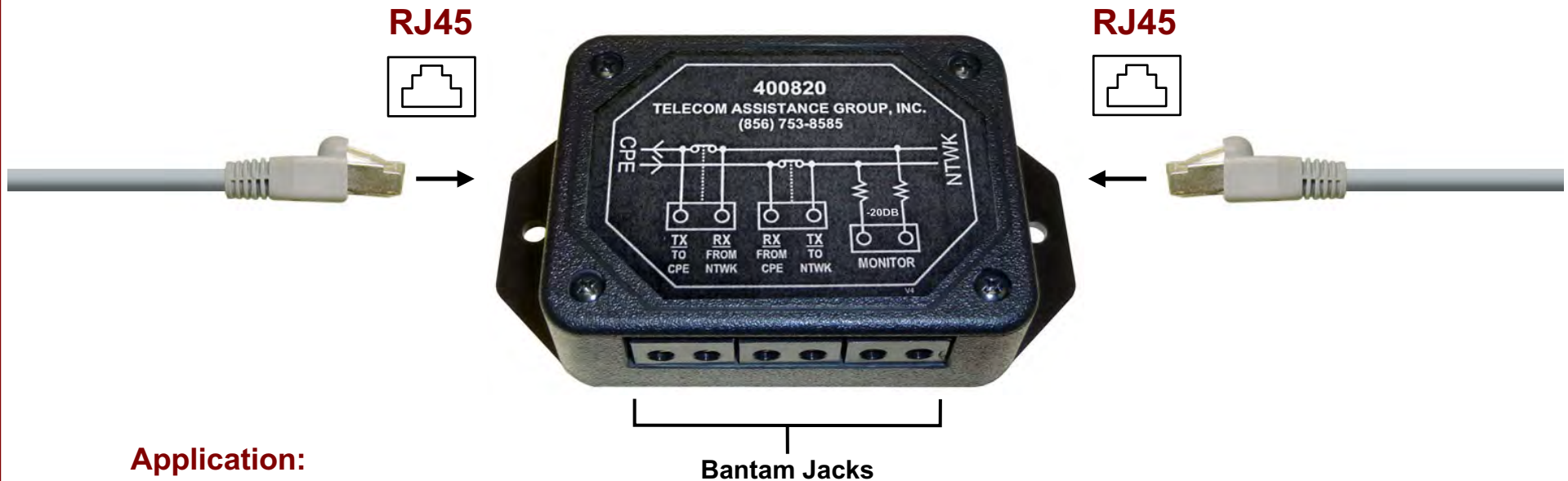

Application:

- ▶ One unit per T1 is required and is installed between the VGW and the customer PBX by the Business Class provider.
- ▶ The 400820 (NID) provides an input (Network) RJ45 port to connect the VGW to the NID. *The Business Class provider will be responsible for providing the connection from the VGW to the 400820 (NID).*
- ▶ An RJ45 port (CPE) provides Business Class customers a connection from PRI and the CPE PBX. *This connection is the customer's responsibility.*
- ▶ Bantam test ports are located on the bottom of the 400820 (NID) for future maintenance and performance testing connected to the preferred test set.

Ordering Information:

T1 Monitor Box

FTR UPN #

400820

150 Cooper Rd. (F-15)
W. Berlin, NJ 08091

www.tagcords.com

Telecom Assistance Group

Telephone: (856) 753-8585

Fax: (856) 768-7645

Remote Network Cable Tester w/ Tone Generator

CAT-107G

Simplify Network Cable Testing !!

Cable Test Features:

- Displays:**
- Short
 - Reversed
 - Miswired
 - Split Pairs

Tone Generator* Features:

- Verification of Shield Integrity
- Puts Tracer Tone on Cable

* Tone Generator function requires customer supplied Cable Tracing Probe

Additional Features:

- Specially designed Remote Unit that enables one person to test installed cables
- Easy to read Fault Display and high speed testing
- Debug mode for detailed fault identification results
- Auto Sleep Mode and Power Off Switch to decrease power consumption
- Low Battery Indicator
- Includes (4) four AAA batteries

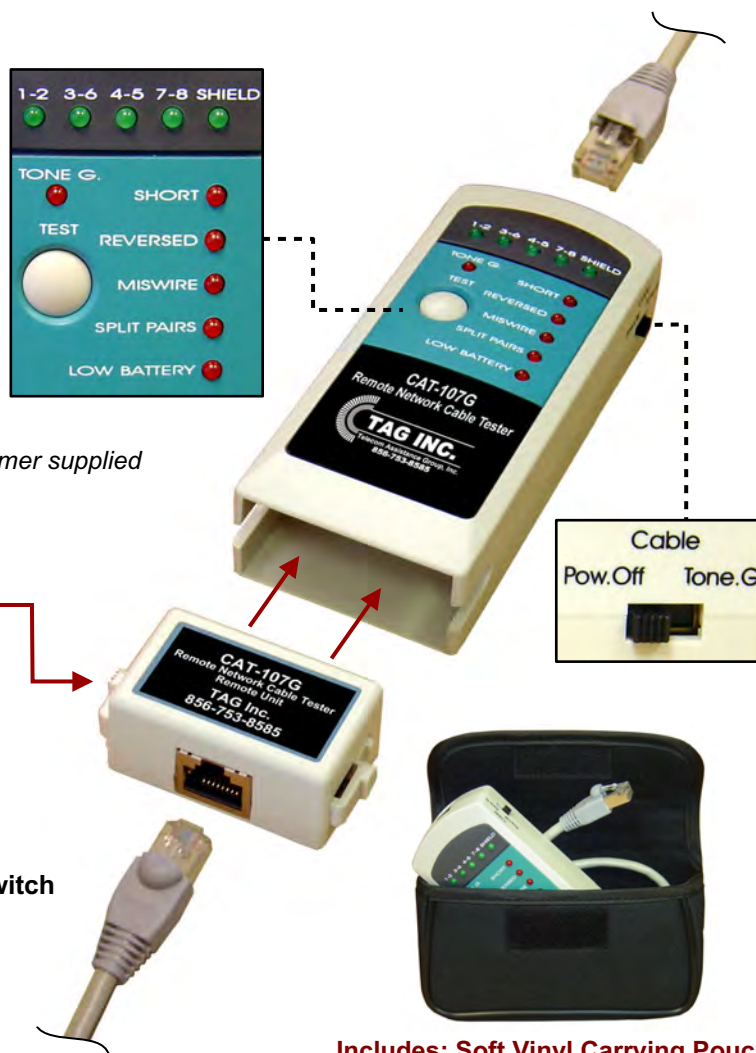

Includes: Soft Vinyl Carrying Pouch & Remote Terminating Cable

Application:

The CAT-107G is a small hand-held cable tester, which enables network professionals to quickly and easily verify the integrity of ethernet twisted pair cables for open pairs, shorted pairs, reversed pairs, crossed pairs and split pairs. Push the TEST button and the CAT-107G will automatically scan for any existing faults in your cable. The specially designed remote terminator is provided for one-person testing of installed cables. The tone generator function can be used to send a signal through installed cables which can be traced with most cable tracers on the market.

Ordering Information:

Remote Network Cable Tester w/ Tone Generator

includes: (1) Carrying Pouch, (1) Remote Terminating Cable & (4) AAA Batteries

FTR UPN #

CAT-107G

150 Cooper Rd. (F-15)
W. Berlin, NJ 08091

www.tagcords.com

Telephone: (856) 753-8585
Fax : (856) 768-7645

Telecom Assistance Group

Dat@Term* Block Test Probe - Single Blade

P-2000DTS

P-2000DTS

Dat@Term* Block Test Probe w/ Protection, Single Blade, (25')

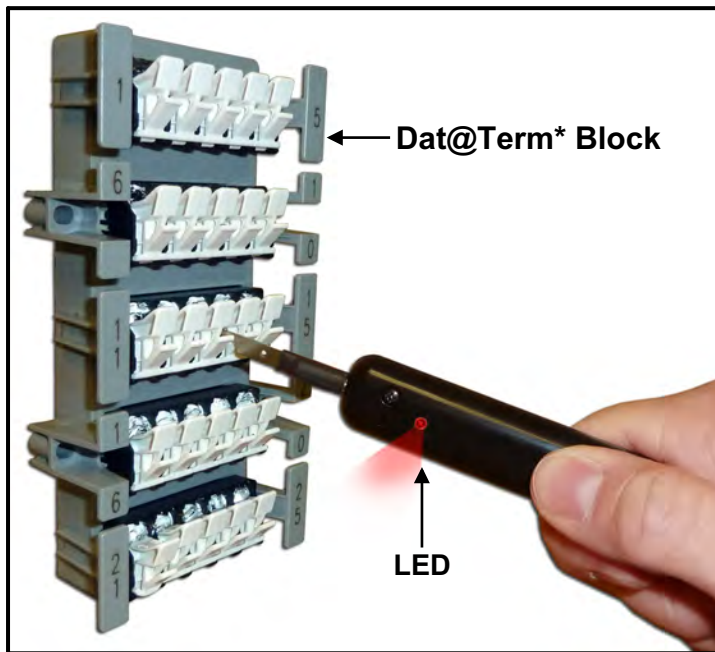
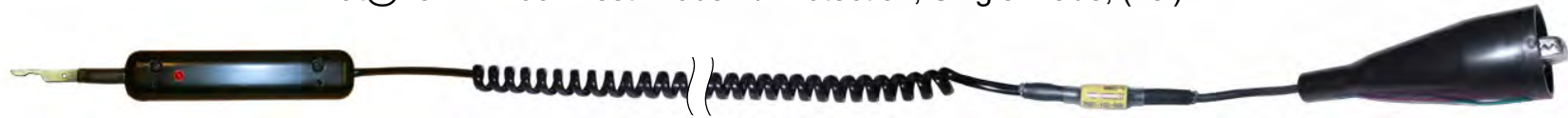

Touch Probe End to TIP / RING on Dat@Term* Block

LED

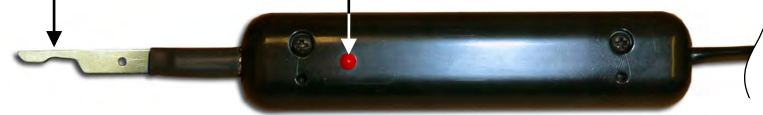

Application:

The P-2000DTS Dat@Term* Block Test Probe is used with TAG Inc. staker cards by outside plant technicians streaking equipment that is wired to a Tyco Dat@Term* Block. The P-2000DTS allows ease of testing Tip/Ring wiring to the Dat@term* Block. The P-2000DTS is -48V protected and is also equipped with an LED for connectivity validation.

Ordering Information:

Dat@Term* Block Test Probe w/ Protection, Single Blade, (25')

FTR UPN #

P-2000DTS

150 Cooper Rd. (F-15)
W. Berlin, NJ 08091

www.tagcords.com

Telecom Assistance Group

Telephone: (856) 753-8585

Fax : (856) 768-7645

VIP Sidekick Module Replacement Cord for IFD, (6')

SBC400190

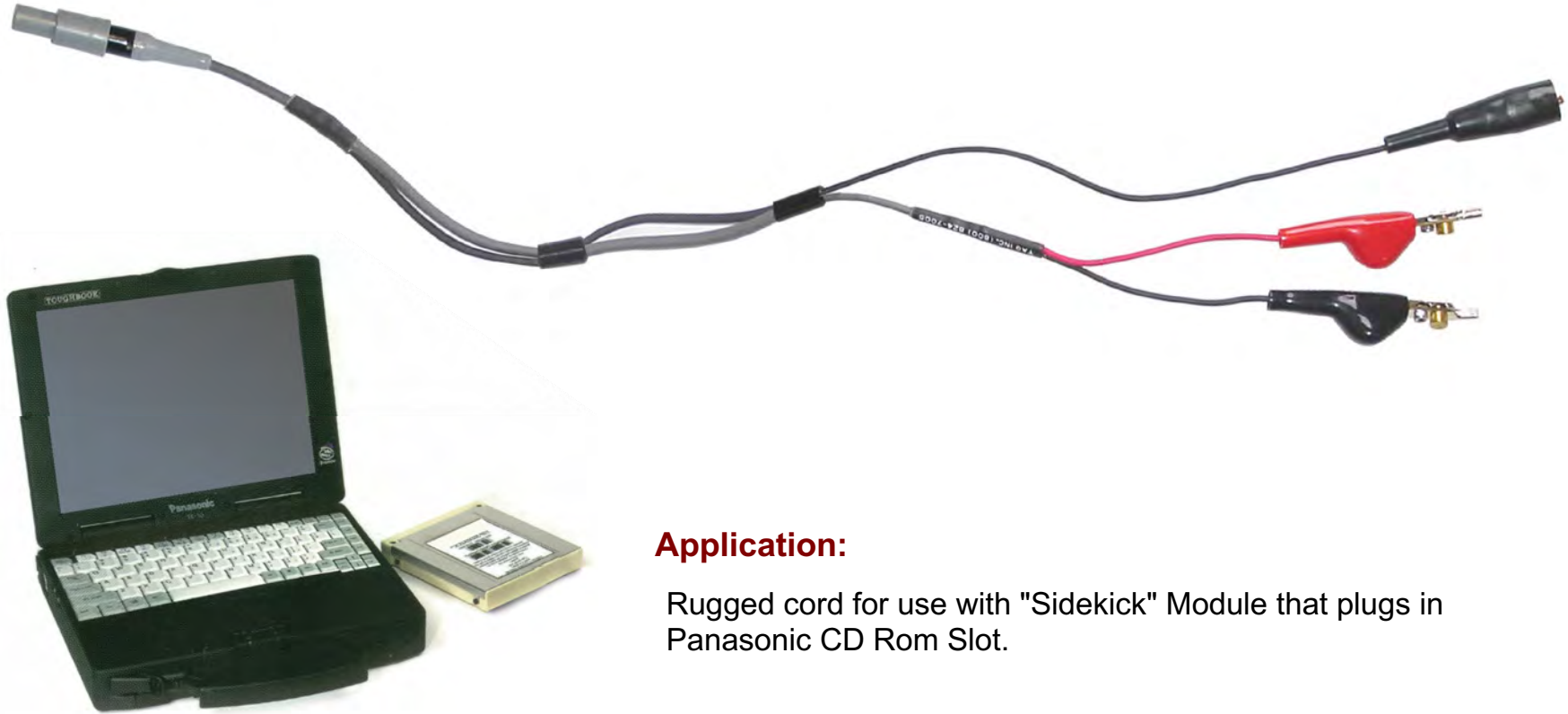

Application:

Rugged cord for use with "Sidekick" Module that plugs in Panasonic CD Rom Slot.

Ordering Information

VIP Sidekick Module Replacement Cord for IFD, (6')

FTR UPN #

SBC400190

150 Cooper Rd. (F-15)
W. Berlin, NJ 08091

www.tagcords.com
Telecom Assistance Group

Telephone: (856) 753-8585
Fax : (856) 768-7645

Wire Placement Pole for Standard Frame

WPP-SF

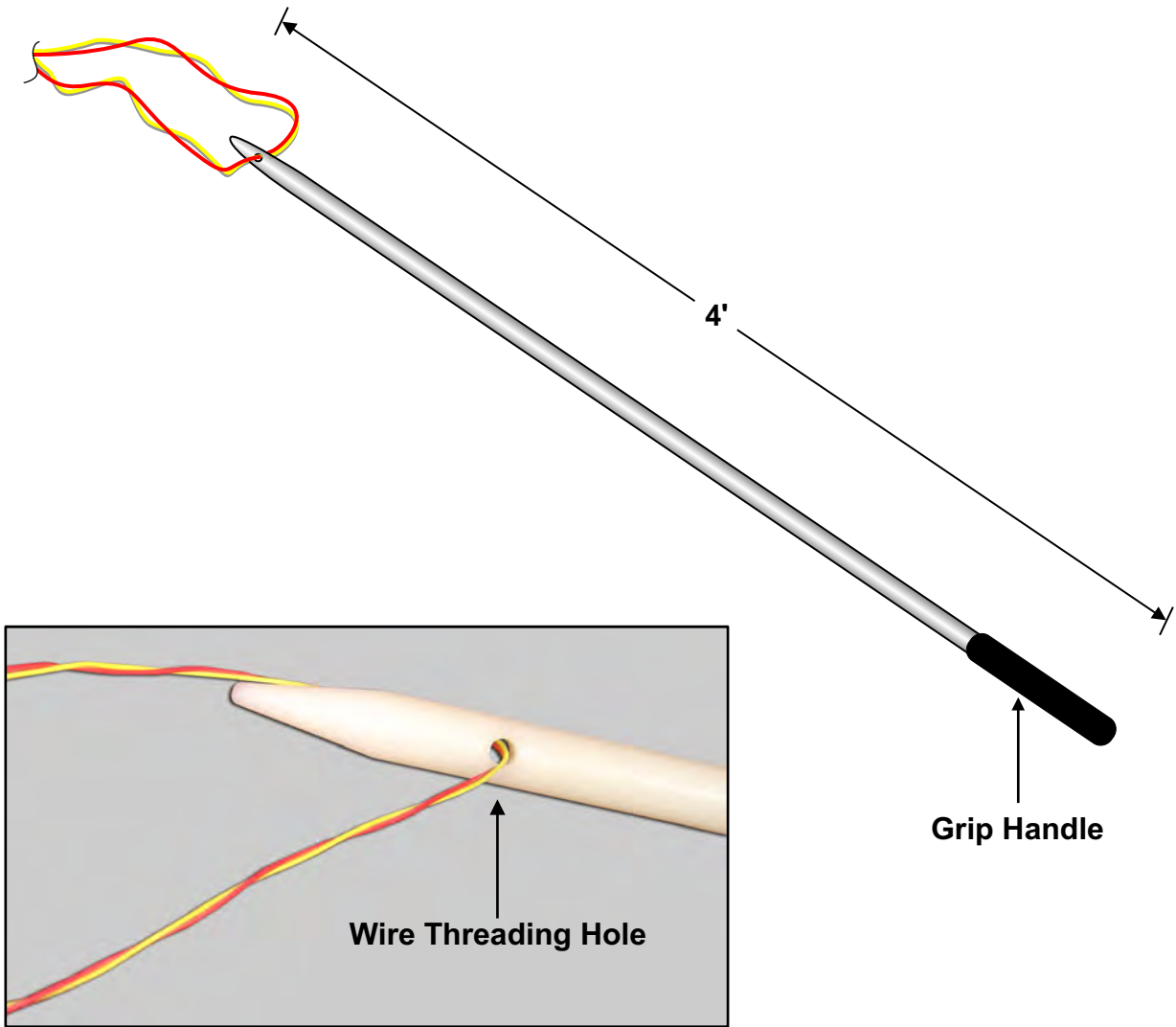

Application:

TAG's Wire Placement Pole (WPP-SF) is used to thread Frame Wire on the Main Distribution Frame (MDF) in the Central Offices.

Ordering Information:	<u>FTR UPN #</u>
Wire Placement Pole for Standard Frame	WPP-SF

150 Cooper Rd. (F-15)
W. Berlin, NJ 08091

www.tagcords.com

Telephone: (856) 753-8585
Fax : (856) 768-7645

Telecom Assistance Group

OSP - HDSL Test Solutions



FTR UPN #
HDSL-P2OSP-KIT

Description:
Portable HDSL(HTU-R) 2 Slot Unit
Holds 2 - 200 Mechanic (SLIM)
or
1 - 400 Mechanic (WIDE)
2W or 4W Cards

Application:

- ▶ Test "New" HDSL Circuits
- ▶ Troubleshoot HDSL Circuits



View with Cards*
*Cards are not included

FTR UPN # 4WSL-4A-08
Universal 2W/4W Remote HDSL Replacement Cord

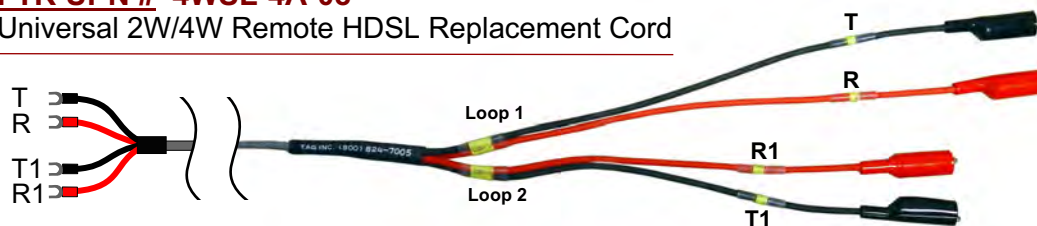

Ordering Information:

Portable HDSL (HTU-R) 2 slot Unit Kit
includes: (1) HDSL-P2OSP & (1) 4WSL-4A-08

Universal 2W/4W Remote HDSL Replacement Cord, (8')

FTR UPN #
HDSL-P2OSP-KIT

4WSL-4A-08

150 Cooper Rd. (F-15)
W. Berlin, NJ 08091

www.tagcords.com

Telephone: (856) 753-8585
Fax : (856) 768-7645

Telecom Assistance Group

DB9M / RS232 to USB Adapter Cable

Need access to a Serial Port on your Laptop?

TAG's Adapter Cable will convert your Laptop's USB Port into a Serial Port!

Serial Port on an Older Laptop

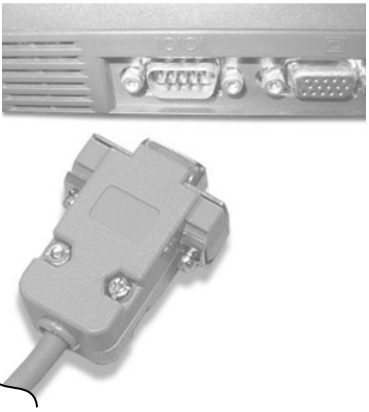



System Requirements:
 - Supports Windows® 2000 / XP / Server 2008 / Vista / 7 / 8 / 10

Ordering Information:	FTR UPN #
DB9M / RS232 to USB Adapter Cable	400720USB

DB9M to DB9F Cables

DB9 Pin (male) to DB9 Pin (female)

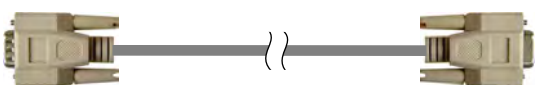

- Commonly used from Laptop to test at Pair Gain (HDSL)
- Wired straight

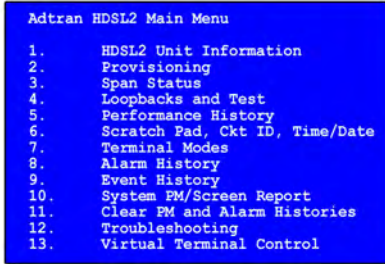



9 Pin connector on HDSL ckt



Ordering Information:	FTR UPN #
DB9 Pin (male) to DB9 Pin (female), (10')	400720-10
DB9 Pin (male) to DB9 Pin (female), (25')	400720-25
DB9 Pin (male) to DB9 Pin (female), (50')	400720-50

150 Cooper Rd. (F-15) W. Berlin, NJ 08091	www.tagcords.com	Telephone: (856) 753-8585 Fax : (856) 768-7645
Telecom Assistance Group		

Multi Function 800 Drop & Insert

400828DI

Four (4) Test Cord Functions:

- White "Near Side"
- Blue "Far Side"
- Orange "Monitor"
- Drop & Insert

In One Test Unit

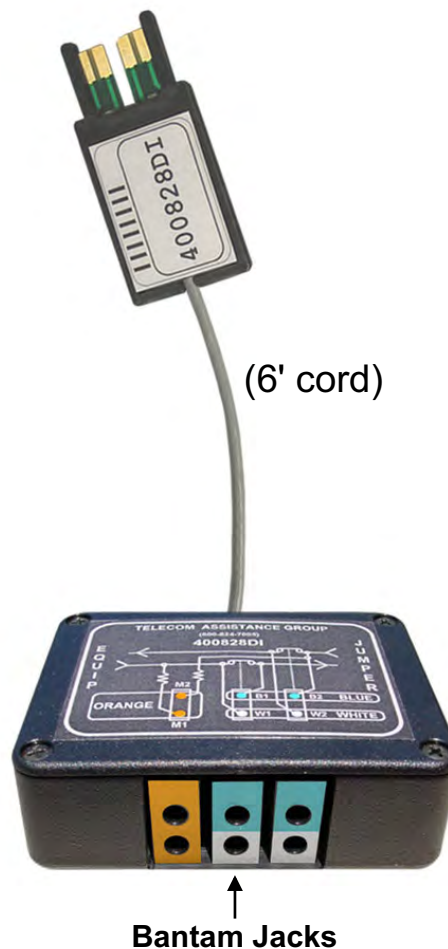
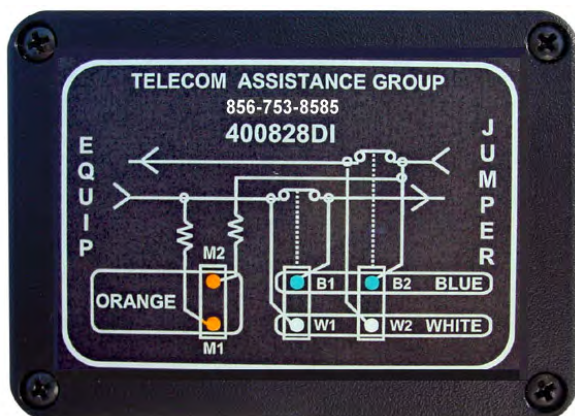

Application:

Telecom Assistance Group's multi-function 800 DSX unit combines four (4) test cord functions in one unit. The 400828DI eliminates the need for Orange, White, Blue cords in various lengths and also provides versatile Drop & Insert capabilities. **Drop & Insert** functions can be **performed at one 800 DSX jackfield** - never have to locate Test Set and use 2 long test cords.

Ordering Information:

Multi-Function 800 DSX Unit / Test Cord, (6')

FTR UPN

400828DI

150 Cooper Rd. (F-15)
W. Berlin, NJ 08091

www.tagcords.com

Telephone: (856) 753-8585
Fax : (856) 768-7645

Telecom Assistance Group

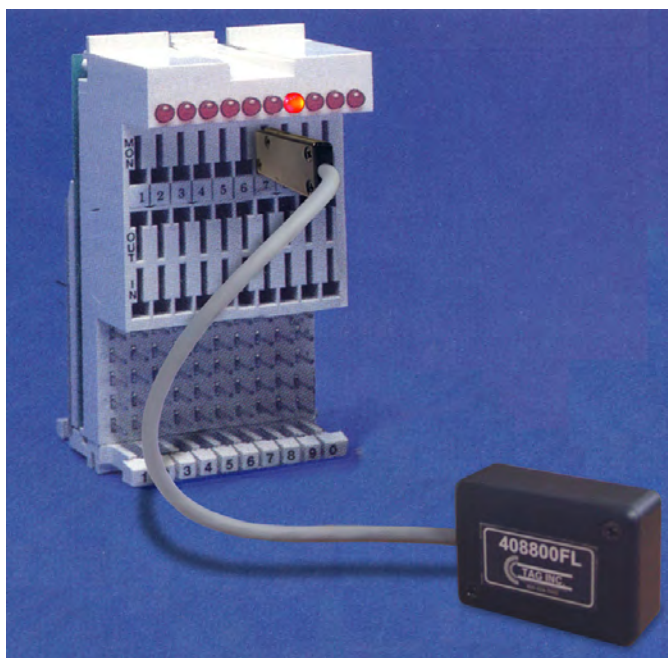
800 DSX Flasher**408800FL****Application:**

The 408800FL (800 DSX Flasher cord) is used for jumper tracing. Insert the 408800FL into the monitor jack to "flash" the corresponding 800 DSX jacks.

Ordering Information:**800 DSX Flasher****FTR UPN #****408800FL**

150 Cooper Rd. (F-15)
W. Berlin, NJ 08091

www.tagcords.com

Telephone: (856) 753-8585
Fax : (856) 768-7645

Telecom Assistance Group

Apparatus Cases (T1, HDSL, DDS)

Ordering Information:

FTR UPN # EXT-238

Description: T1 Line
Repeater Access Board

- Plugs in "mini" T1 Line Repeater Slots in 818, 819 apparatus cases or other T1 apparatus cases that house (238/239 type repeaters)
- Provides access to wiring via Bantam Jacks.



Ordering Information:

FTR UPN # EXT-209B

Description: T1 Loopback Extender

- Universal interface to all test sets
- Loops signal and simplex current
- Isolates trouble to repeater or cable
- Bantam Jack access eliminates special probes and cables
- Direct metallic bridging allows current, voltage and loop resistance measurements

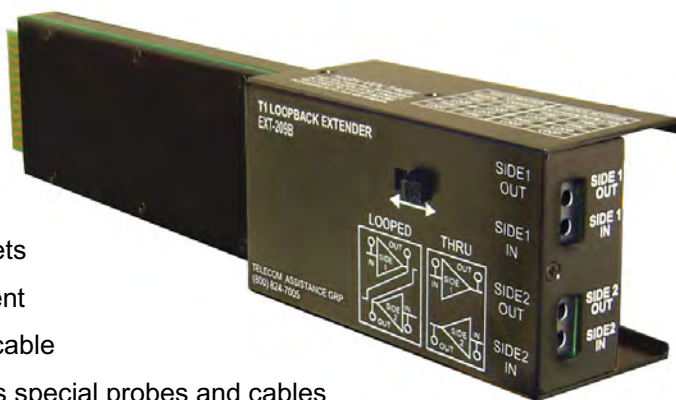

Ordering Information:

FTR UPN # EXT-209T

Description: T1 Repeater Extender

- Span current test points
- Loops signal and simplex current
- Test repeaters in the field
- Bantam Jack access to monitor/transmit QRSS, 3 in 24 from test sets
- Direct metallic bridging allows current, voltage and loop resistance measurements



150 Cooper Rd. (F-15)
W. Berlin, NJ 08091

www.tagcords.com

Telecom Assistance Group

Telephone: (856) 753-8585
Fax : (856) 768-7645

T1 Repeater Test Kit

EXT-238K3

The EXT-238K3 Kit is designed for technicians who test at T1 Line Repeater Housings, such as 818 apparatus cases. (see Fig. 1)

The Kit Includes:



(1) EXT-238
T1 Line Repeater Access Board



(1) 600209
Carrying Case

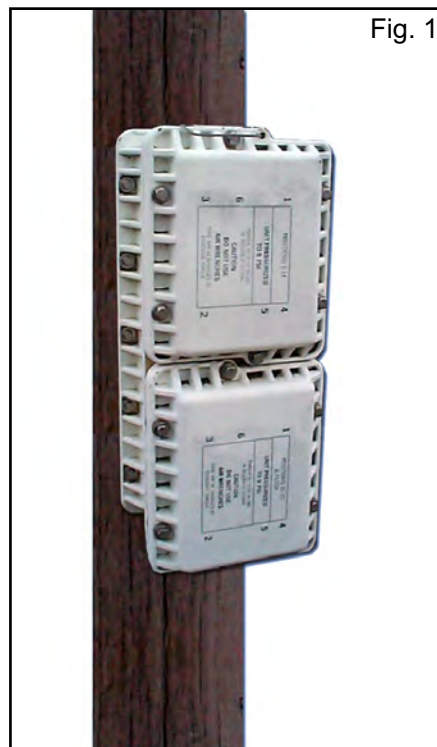

Fig. 1



(1) 400210RD-03
Bantam to Bantam, (3') - Red



(1) 400210ARD-03
Bantam to Alligator Clips, (3') - Red



(1) 400210BK-03
Bantam to Bantam, (3') - Black



(1) 400210ABK-03
Bantam to Alligator Clips, (3') - Black

Ordering Information:

T1 Repeater Access Kit

includes: (1) EXT-238, (1) 400210RD-03, (1) 400210BK-03,
(1) 400210ARD-03, (1) 400210ABK-03 & (1) 600209

T1 Line Repeater Access Board

Carrying Case

KIT FTR UPN #
EXT-238K3

EXT-238

600209

150 Cooper Rd. (F-15)
W. Berlin, NJ 08091

www.tagcords.com

Telephone: (856) 753-8585
Fax : (856) 768-7645

Telecom Assistance Group

Apparatus Cases (T1, HDSL, DDS)

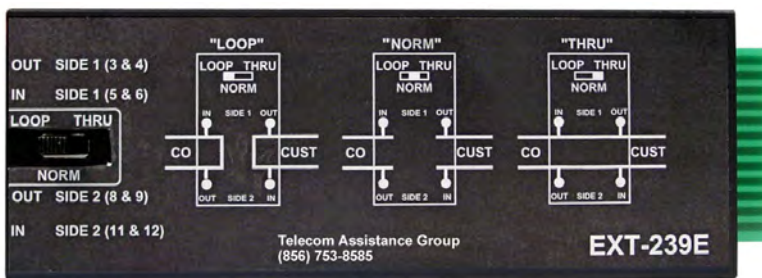

Plugs into T1, 56KB, HDSL, ISDN Apparatus Cases



** Replaces 254A

FTR UPN

EXT-239E

T1 Repeater Wiring Access Board
(w/ Bantam Jacks)

Application:

The EXT-239 has enhanced switch settings for Thru, Norm and Loop testing at T1 line repeater apparatus cases. It also provides metallic access at T1 line repeater slots. Use the EXT-239E with test sets to perform Cable Loss, Resistance or TDR test set to locate load coils.

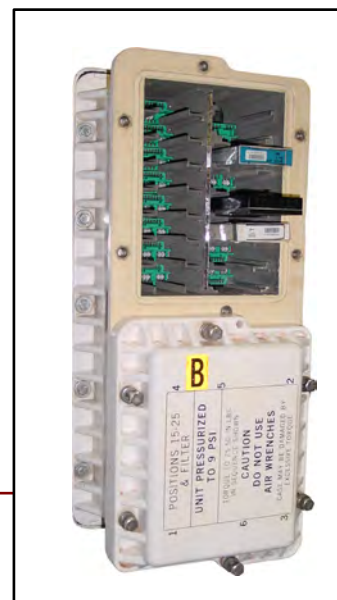

Accessories:

Carrying Case

FTR UPN

600209



FTR UPN

CT-238/239

T1 Line Repeater Cut Thru Card

Application:

The CT-238/239 plugs into T1, 56KB, HDSL, and ISDN apparatus cases. Plug the CT-238/239 into non-powered mini T1 line repeater slots to bypass unused pairs for line testing.

150 Cooper Rd. (F-15)
W. Berlin, NJ 08091

www.tagcords.com

Telephone: (856) 753-8585

Fax : (856) 768-7645

Telecom Assistance Group

Extended 239 SHDSL Wiring Access Board Kit

KIT-E239L

Longer Test Unit for Extended Label Visibility



(1) FTR UPN # EXT-E239L
Extended **239 SHDSL** Wiring Access Board
w/ Bantam Jacks

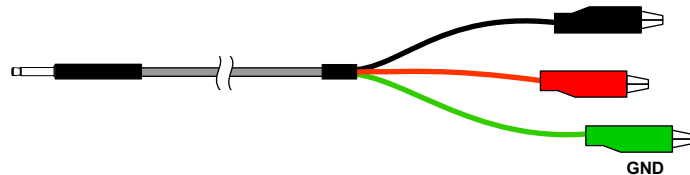

(1) PN # 400210A3BK
Bantam to (3) Alligator Clips - Black, (6')



**KIT
INCLUDES
CARRYING
CASE**

(1) FTR UPN # 600209
Carrying Case
Approx. Dimensions:
5" (H) x 16" (L)

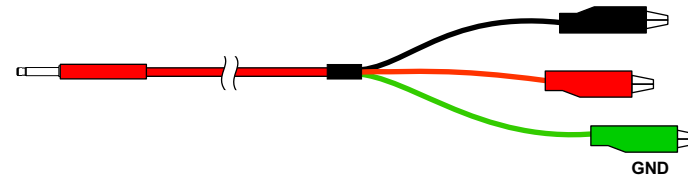

(1) PN # 400210A3RD
Bantam to (3) Alligator Clips - Red, (6')

Ordering Information:

Extended 239 SHDSL Wiring Access Board Kit
includes: (1) EXT-E239L, (1) 400210A3BK, (1) 400210A3RD & (1) 600209

FTR UPN #
KIT-E239L

Extended 239 SHDSL Wiring Access Board w/ Bantam Jacks

EXT-E239L

150 Cooper Rd. (F-15)
W. Berlin, NJ 08091

www.tagcords.com
Telecom Assistance Group

Telephone: (856) 753-8585
Fax : (856) 768-7645

ORB - (HDSL/T1) ORB Shelves

FTR UPN # TB-231
 220 Office Repeater Test Board
 (w/ Pin Jacks)

Application:

The TB-231 provides metallic access via pin jacks commonly used with volt/ohm meters to test at office repeater card slots. Utilizing standard test sets and test cords, the TB-231 becomes a powerful tool in testing in the Central Office, Remote Terminals, and CEV's.



HDSL Remote HRU - 200/400 Mechanics

Plugs into Remote HRU HDSL shelves, doublers (200/400 Mechanics)

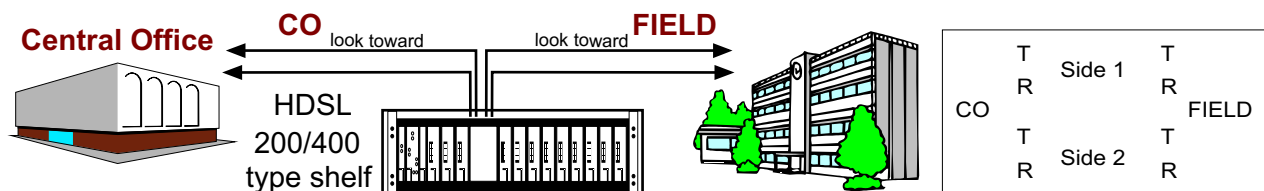

FTR UPN # TB-400B
 200/400 Shelf HDSL Test Board
 (w/ Bantam Jacks)

Application:

The TB-400B (bantam jacks) provides metallic access wiring in 200/400 HDSL type shelves. It allows the technician to verify and test wiring towards the CO and CPE. Easy testing before turn-up dates. With test equipment, a technician can quickly identify opens, shorts, crosses, and transmit & receive signals between the shelf and CO or CPE.

150 Cooper Rd. (F-15)
 W. Berlin, NJ 08091

www.tagcords.com

Telephone: (856) 753-8585
 Fax : (856) 768-7645

Telecom Assistance Group

Adtran TA5000 ADSL Splitter Streaker Kit

KIT-T5K-SPLTRA



The Kit Includes:

(1) ST-T5K-SPLTRA
Adtran TA5000 ADSL Splitter Streaker Card
 32 Port (w/ 128 LEDs)

Application:

The ST-T5K-SPLTRA provides a quick method to "streak", verify wiring via LEDs, from the backplane of the Adtran TA5000 (1187450L1, 1187450G1) to the Frame. At the Frame simply ground the corresponding pins and the ST-T5K-SPLTRA will light the LED associated with that connection.



Approx. Dimensions:
 9" (H) x 16" (L)



(1) 400409
 Pin Plug to Alligator, (6')



(1) P-2000
 Protected (-48V) Continuity Test Probe
 w/ LED, Long Pin



(1) 600209N
 Carrying Case

Ordering Information:

Adtran TA5000 ADSL Splitter Streaker Kit
 includes: (1) ST-T5K-SPLTRA, (1) 400409, (1) P-2000 & (1) 600209N

KIT FTR UPN #
KIT-T5K-SPLTRA

Protected (-48V) Continuity Test Probe w/ LED, Long Pin

P-2000

Carrying Case

600209N

150 Cooper Rd. (F-15)
 W. Berlin, NJ 08091

www.tagcords.com

Telephone: (856) 753-8585
 Fax : (856) 768-7645

Telecom Assistance Group

Adtran TA5000 SHDSL Streaker Kit

KIT-T5K-SHDSL1



The Kit Includes:

(1) ST-T5K-SHDSL

Adtran TA5000 SHDSL Streaker Card
32 Port (w/ 64 LEDs)

Application:

The ST-T5K-SHDSL provides a quick method to "streak", verify wiring via LEDs, from the backplane of the Adtran TA5000 (1187450L1, 1187450G1) to the Frame. At the Frame, simply ground the corresponding pins and the ST-T5K-SHDSL will light the LED associated with that connection.



Approx. Dimensions:
9" (H) x 16" (L)



(1) 400409
Pin Plug to Alligator, (6')



(1) P-2000
Protected (-48V) Continuity Test Probe w/ LED, Long Pin



(1) 600209N
Carrying Case

Ordering Information:

Adtran TA5000 SHDSL Streaker Kit

includes: (1) ST-T5K-SHDSL, (1) 400409, (1) P-2000 & (1) 600209N

Protected (-48V) Continuity Test Probe w/ LED, Long Pin

Carrying Case

KIT FTR UPN #
KIT-T5K-SHDSL1

P-2000

600209N

150 Cooper Rd. (F-15)
W. Berlin, NJ 08091

www.tagcords.com

Telephone: (856) 753-8585
Fax : (856) 768-7645

Telecom Assistance Group

Adtran TA5000 V2 Splitter Streaker Kit

KIT-T5K-SPLTRV



The Kit Includes:

(1) ST-T5K-SPLTRV
Adtran TA5000 V2 Splitter Streaker Card
 32 Port (w/ 128 LEDs)

Application:

The ST-T5K-SPLTRV provides a quick method to "streak", verify wiring via LEDs, from the backplane of the Adtran TA5000 (1187450L1, 1187450G1) to the Frame. At the Frame simply ground the corresponding pins and the ST-T5K-SPLTRV will light the LED associated with that connection.



Approx. Dimensions:
 9" (H) x 16" (L)



(1) 400409
 Pin Plug to Alligator, (6')



(1) P-2000
 Protected (-48V) Continuity Test Probe
 w/ LED, Long Pin



(1) 600209N
 Carrying Case

Ordering Information:

Adtran TA5000 V2 Splitter Streaker Kit
 includes: (1) ST-T5K-SPLTRV, (1) 400409, (1) P-2000 & (1) 600209N

Adtran TA5000 V2 Splitter Streaker Card w/ LEDs
Protected (-48V) Continuity Test Probe w/ LED, Long Pin
Carrying Case

KIT FTR UPN #
KIT-T5K-SPLTRV

ST-T5K-SPLTRV
P-2000
600209N

150 Cooper Rd. (F-15)
 W. Berlin, NJ 08091

www.tagcords.com

Telephone: (856) 753-8585
 Fax : (856) 768-7645

Telecom Assistance Group

Adtran TA5000 Combo Streaker Kit

KIT-T5K-COMBO



The Kit Includes:

(1) ST-T5K-COMBO
Adtran TA5000 Combo Streaker Card
 24 Port (w/ 48 LEDs)

Application:

The ST-T5K-COMBO provides a quick method to "streak", verify wiring via LEDs, from the backplane of the Adtran TA5000 (1187410L1, 1187410G1, 1187411L1, 1187411G1) to the Frame. At the Frame simply ground the corresponding pins and the ST-T5K-COMBO will light the LED associated with that connection.



Approx. Dimensions:
 9" (H) x 16" (L)



(1) 400409
 Pin Plug to Alligator, (6')



(1) P-2000
 Protected (-48V) Continuity Test Probe
 w/ LED, Long Pin



(1) 600209N
 Carrying Case

Ordering Information:

Adtran TA5000 Combo Streaker Kit
 includes: (1) ST-T5K-COMBO, (1) 400409, (1) P-2000 & (1) 600209N

Adtran TA5000 Combo Streaker Card w/ LEDs
Protected (-48V) Continuity Test Probe w/ LED, Long Pin
Carrying Case

KIT FTR UPN #
KIT-T5K-COMBO

ST-T5K-COMBO
P-2000
600209N

150 Cooper Rd. (F-15)
 W. Berlin, NJ 08091

www.tagcords.com

Telephone: (856) 753-8585
 Fax : (856) 768-7645

Telecom Assistance Group

Adtran TA5000 48 Port COMBO Streaker Kit

KIT-T5K-COMBO48



The Kit Includes:

(1) ST-T5K-COMBO48
Adtran TA5000 Combo Streaker Card
 48 Port (w/ 96 LEDs)

Application:

The ST-T5K-COMBO48 provides a quick method to "streak", verify wiring via LEDs, from the backplane of the Adtran TA5000 to the Frame. At the Frame simply ground the corresponding pins & the streaker card will light the LED associated with that connection.



(1) 600209F Approx. Dimensions:
 Carrying Case 13" (H) x 20" (L)



(1) P-2000
 Protected (-48V) Test Probe
 w/ LED, Long Pin



(1) 400409
 Pin Plug to Alligator, (6')

Ordering Information:

Adtran TA5000 COMBO Streaker Kit
48 Port (w/ 96 LEDs)

includes: (1) ST-T5K-COMBO48, (1) 400409, (1) P-2000 & (1) 600209F

KIT-T5K-COMBO48
 (call for pricing)

Adtran TA5000 COMBO Streaker Card
48 Port (w/ 96 LEDs)

FTR UPN #
ST-T5K-COMBO48

150 Cooper Rd. (F-15)
 W. Berlin, NJ 08091

www.tagcords.com

Telephone: (856) 753-8585
 Fax : (856) 768-7645

Telecom Assistance Group

Adtran TA5000 VDSL2 Splitter Streaker Kit

KIT-T5K-SPLT24VL

" Low Profile "



The Kit Includes:

(1) ST-T5K-SPLT24VL
Adtran TA5000 VDSL2 Splitter
Streaker Card (Low Profile)
24 Port (w/ 96 LEDs)

Application:

The ST-T5K-SPLT24VL provides a quick method to "streak", verify wiring via LEDs, from the backplane of the Adtran TA5000 Splitter Shelf (1187870G1) to the MDF.

At the MDF simply ground the corresponding pins & the Streaker Card will light the LED associated with that connection.



(1) 600209F
 Carrying Case

Approx. Dimensions:
 13" (H) x 20" (L)



(1) 400409
 Pin Plug to Alligator, (6')



(1) P-2000
 Protected (-48V) Continuity Test Probe
 w/ LED, Long Pin

Ordering Information:

Adtran TA5000 VDSL2 Splitter Streaker Kit (Low Profile)
24 Port (w/ 96 LEDs)

KIT-T5K-SPLT24VL
 (call for pricing)

includes: (1) ST-T5K-SPLT24VL, (1) 400409, (1) P-2000 & (1) 600209F

Adtran TA5000 VDSL2 Splitter Streaker Card (Low Profile)
(24 Port w/ 96 LEDs)

FTR UPN #
ST-T5K-SPLT24VL

150 Cooper Rd. (F-15)
 W. Berlin, NJ 08091

www.tagcords.com

Telephone: (856) 753-8585
 Fax : (856) 768-7645

Telecom Assistance Group

T-Berd* 209 OSP / 107A Test Set Batteries & Accessories

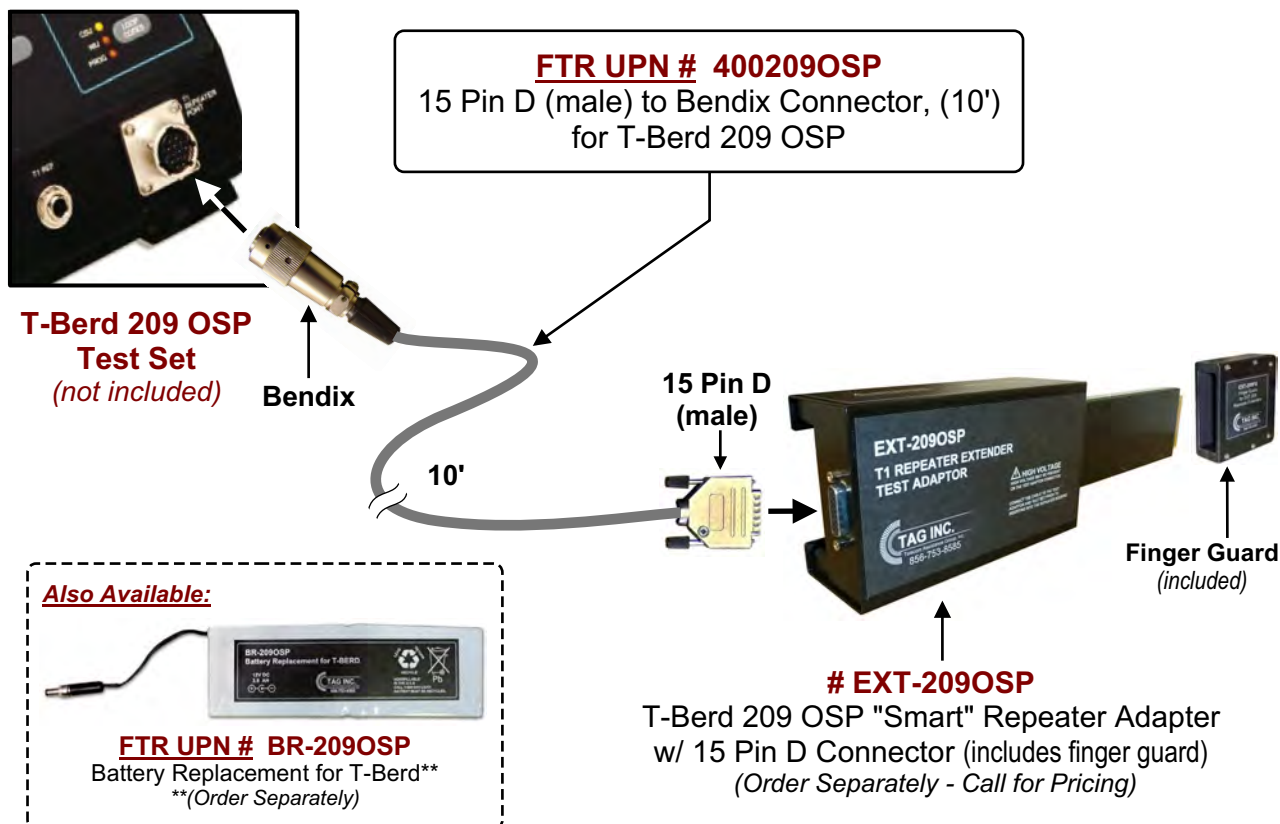

Application:

The TAG # 400209OSP is an auto-test replacement cable for the T-Berd 209 OSP. It connects from the Bendix connector on the T-Berd 209 OSP Test Set to the 15 pin connector on the "smart" repeater adapter (TTC 41754 or TAG's # EXT-209OSP).

Ordering Information:

	FTR UPN #
15 Pin D (male) to Bendix Connector, (10') for T-Berd 209 OSP	400209OSP
Battery Replacement for T-Berd 209 OSP	BR-209OSP
Battery Replacement for T-Berd 107A (not shown)	BR-107A
Replacement Power Pack for T-Berd 107A (not shown)	BR-107A-PP
T-Berd 209 OSP Auto Test T1 Repeater Test Kit	KIT-209OSP
includes: (1) EXT-209OSP, T-Berd 209 OSP "Smart" Repeater Adapter w/ 15 Pin D Connector (includes Finger Guard # EXT-209FG)	
(1) 400209OSP, 15 Pin D (male) to Bendix Connector, (10') & (1) 600209N - carrying case	

Also Available:

T-Berd 209 OSP "Smart" Repeater Adapter w/ 15 Pin D Connector (includes Finger Guard # EXT-209FG)	EXT-209OSP (call for pricing)
--	---

150 Cooper Rd. (F-15)
W. Berlin, NJ 08091

www.tagcords.com

Telephone: (856) 753-8585
Fax : (856) 768-7645

Telecom Assistance Group

Alcatel 7330 Standard Streaker Kit

7330KIT-02



(1) CT-7330*
Alcatel 7330 Streaker Unit
*(streaker unit only)

KIT FTR UPN #
7330KIT-02
Alcatel 7330
Standard Streaker Kit



(1) 400409
Pin Plug to Alligator, (6')



(1) P-2000
Protected (-48V) Continuity Test Probe
w/ LED, Long Pin



(1) 600209N
Carrying Case



(1) 400188
Amphenol Test Cable, (8')

Application:

The 7330 Standard Streaker Kit provides a quick method to verify continuity from the 7330 to Wire Termination Points - checking all interconnect cabling and connectors. The Testers will ground the terminating points and verify that wiring is correct via LED's.

Ordering Information:

Alcatel Standard Streaker Kit

includes: (1) CT-7330, (1) 400409, (1) 400188, (1) P-2000,
(1) 3004935-502 (manual) & (1) 600209N - carrying case

Protected (-48V) Continuity Test Probe w/ LED, Long Pin

P-2000

Carrying Case

600209N

KIT FTR UPN #
7330KIT-02

150 Cooper Rd. (F-15)
W. Berlin, NJ 08091

www.tagcords.com

Telephone: (856) 753-8585
Fax : (856) 768-7645

Telecom Assistance Group

Alcatel 7330 RT DSLAM Streaker Kit

7330KIT-OSP



(1) CT-7330*
Alcatel 7330 Streaker Unit
*(streaker unit only)

KIT FTR UPN #
7330KIT-OSP
Alcatel 7330
RT DSLAM Streaker Kit



(1) 400409X
Grounding Cord, Pin Plug to Large GND Clip, (6')



(1) P-2000
Protected (-48V) Continuity Test Probe
w/ LED, Long Pin



(1) 600209N
Carrying Case



(1) 400188-50
Amphenol Test Cable, (50')

Application:

The 7330 RT DSLAM Streaker Kit provides a quick method to verify continuity from the 7330 to Wire Termination Points - checking all interconnect cabling and connectors. The Tester will ground the terminating points and verify that wiring is correct via LED's.

Ordering Information:

Alcatel RT DSLAM Streaker Kit

includes: (1) CT-7330, (1) 400409X, (1) 400188-50, (1) P-2000,
(1) 3004935-503 (manual) & (1) 600209N - carrying case

KIT FTR UPN #
7330KIT-OSP

Protected (-48V) Continuity Test Probe w/ LED, Long Pin **P-2000**

Carrying Case **600209N**

150 Cooper Rd. (F-15)
W. Berlin, NJ 08091

www.tagcords.com

Telephone: (856) 753-8585
Fax : (856) 768-7645

Telecom Assistance Group

25 Pair Amphenol Streaker Unit

CT-50

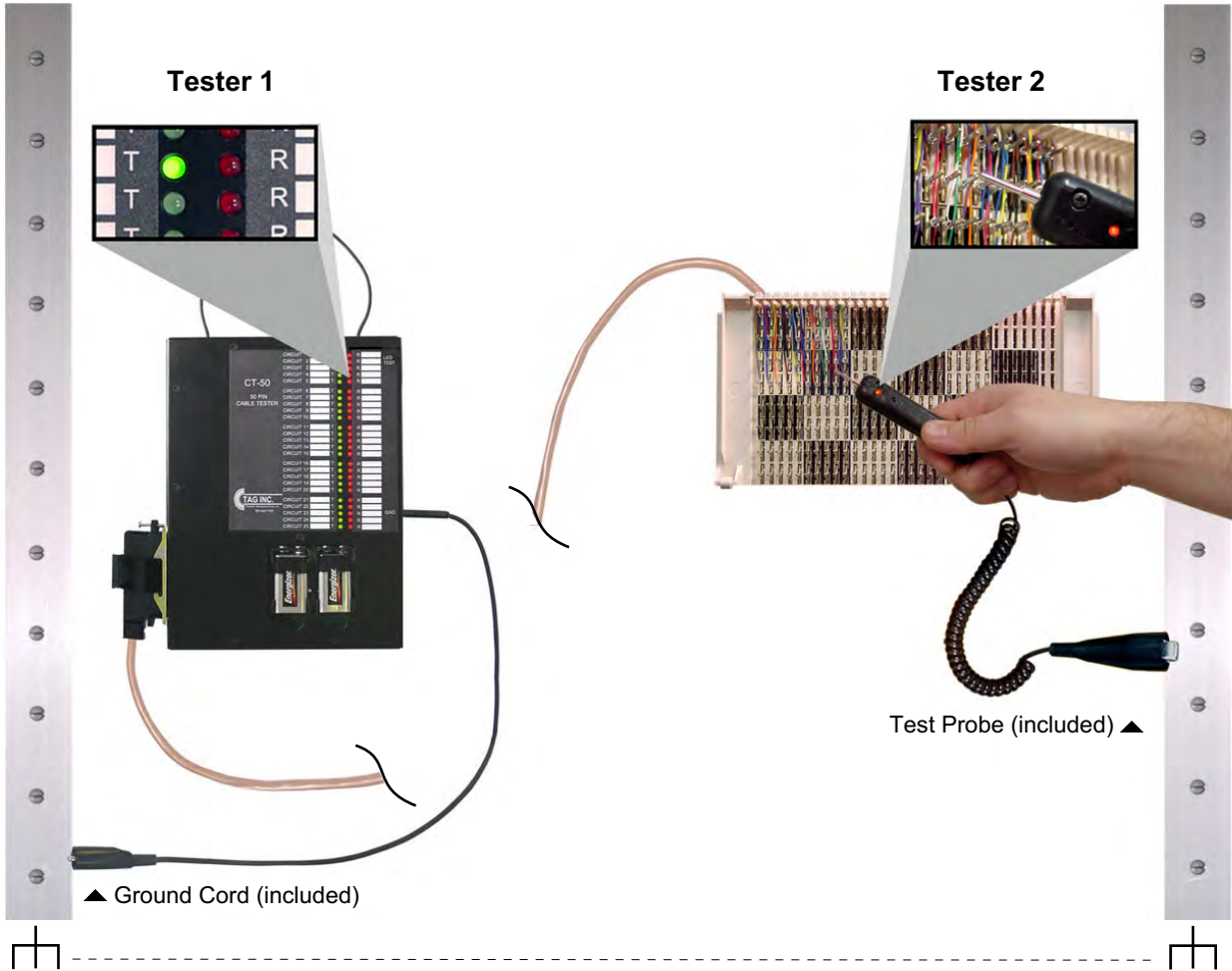

Application:

The **CT-50** provides a quick continuity "streaker" test with LEDs. Two installers can quickly test any equipment that uses 50 Pin Amphenol cables.

Tester 1 connects a 50 Pin Amphenol cable to the CT-50. Tester 2 scans the 50 terminated wires (ex. wire wrap block). Tester 2 uses the P-2000 (Protected Test Probe included) to touch the wire wrap pins to verify that the Amphenol pinout corresponds with the wire wrap connection points (ex. Pin 1 Amphenol = Ring - Pair 1 at the Wire Wrap Block).

Ordering Information:	FTR UPN #
25 Pair Streaker Unit w/ LEDs (Tip-Pin 1, Ring-Pin 26) <i>includes: Test Probe, Ground Cord and Extension Cable</i>	CT-50

150 Cooper Rd. (F-15)
W. Berlin, NJ 08091

www.tagcords.com

Telephone: (856) 753-8585
Fax: (856) 768-7645

Telecom Assistance Group

Megalink Cord Kit

KIT-T1



(1) 8 Pouch Carrying Case
TCC-001

Test Cord Kit for Megalink Test Sets

(2) Female Bantam to Alligator Clips, (1')
400200F-01



(1) Bantam to Bantam (15') Red, # 400210RD-15
(1) Bantam to Bantam (15') Black, # 400210BK-15



(2) Female Bantam to Wire Wraps, (1')
400200FWP-01



(1) Bantam "Y" to RJ48 (T1), (8')
400248Y



(2) Female Bantam to 800 DSX (Thin), (1')
408210FT



(2) Bantam to 310 Conversion Plug
400239BST

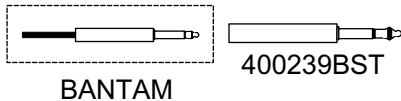

(1) RJ48 to RJ48, (6')
400448



(1) Protector to Alligator Clips, (3')
400300RG-03



Ordering Information:

Megalink Cord Kit

includes: (2) 400200F-01, (2) 400200FWP-01, (2) 408210FT,
(1) 400448, (1) 400210RD-15, (1) 400210BK-15,
(1) 400248Y, (2) 400239BST, (1) 400300RG-03 & (1) TCC-001

KIT FTR UPN #
KIT-T1

150 Cooper Rd. (F-15)
W. Berlin, NJ 08091

www.tagcords.com

Telephone: (856) 753-8585
Fax : (856) 768-7645

Telecom Assistance Group

DS1/DS3 Cord Kit

DS1 (T1 Cords) Bantam Jack on Test Set

- (1) Bantam to Bantam, (8') - Red # 400210RD-08
- (1) Bantam to Bantam, (8') - Black # 400210BK-08



- (1) Bantam to Alligator Clips, (8') - Red # 400210ARD-08
- (1) Bantam to Alligator Clips, (8') - Black # 400210ABK-08

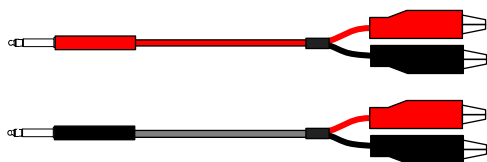

- (1) Bantam to Protector, (8') - Red # 400210SRD-08
- (1) Bantam to Protector, (8') - Black # 400210SBK-08

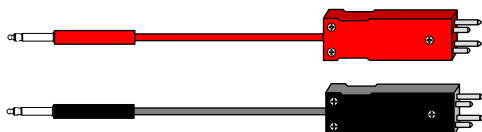

- (1) Bantam "Y" to RJ48 -T1, (8') # 400248

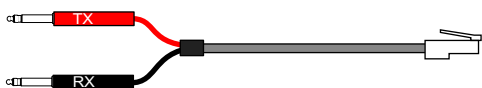

- (1) Bantam to 310 Adapter - Red # 400239RD
- (1) Bantam to 310 Adapter - Black # 400239BK

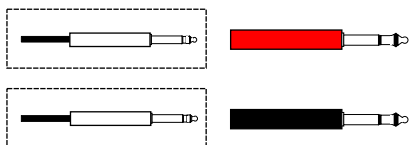

DS3 (T3 Cords) 440A Jack (Weco560A) on Test Set

- (1) 440A to 440A, (8') - Red # 400440ARD-08
- (1) 440A to 440A, (8') - Black # 400440ABK-08



- (1) 440A to 358A (8') - Red # 440358ARD-08
- (1) 440A to 358A (8') - Black # 440358ABK-08



- (1) 440A to BNC (8') - Red # 400440BRD-08
- (1) 440A to BNC (8') - Black # 400440BBK-08



- (1) 8 Pocket Carrying Case # TCC-001P

Ordering Information:

DS1/DS3 Cord Kit

KIT FTR UPN #
2209KIT

150 Cooper Rd. (F-15)
W. Berlin, NJ 08091

www.tagcords.com

Telephone: (856) 753-8585
Fax : (856) 768-7645

Telecom Assistance Group

Fiber Optic Test Cord Kit

FOTC-KIT

Fiber Optic Test Cords Included in Kit:

Carrying Case included with Kit



(2) 430766M-03

SC to SC, Singlemode Simplex, 3.0mm yellow, UPC Test Cord, 3 Meters



(2) 430766AAM-03

SC to SC, Singlemode Simplex, 3.0mm yellow, APC Test Cord, 3 Meters



(2) 430766AM-03

SC/UPC to SC/APC, Singlemode Simplex, 3.0mm yellow, Test Cord, 3 Meters



(2) 430779AM-03

SC/APC to ST/UPC, Singlemode Simplex, 3.0mm yellow, Test Cord, 3 Meters



(2) 430779M-03

SC to ST, Singlemode Simplex, 3.0mm yellow, UPC Test Cord, 3 Meters



(2) 430766MM-03

SC to SC, Multimode Simplex, 3.0 mm 62.5 μm orange, UPC Test Cord, 3 Mtrs



(2) 430773M-03

SC to LC, Singlemode Simplex, 3.0mm yellow, UPC Test Cord, 3 Meters



(2) 430773AM-03

SC/UPC to LC/APC, Singlemode Simplex, 3.0mm yellow, Test Cord, 3 Meters



(2) 430770M-03

SC to FC, Singlemode Simplex, 3.0mm yellow, UPC Test Cord, 3 Meters



(2) 430778M-03

SC to D4, Singlemode Simplex, 3.0mm yellow, UPC Test Cord, 3 Meters

Fiber Optic Adapters Included in Kit:

(1) 400766C
SC to SC
Simplex
UPC Coupler



(1) 400766AC
SC to SC
Simplex
APC Coupler



(1) 400781C
LC to LC
Simplex
UPC Coupler



(1) 400781AC
LC to LC
Simplex
APC Coupler



(1) 400758C
ST to ST
Simplex
UPC Coupler



(1) 400752C
FC to FC
Simplex
UPC Coupler



(1) 400756C
D4 to D4
Simplex
UPC Coupler



Ordering Information:

Fiber Optic Test Cord Kit

includes: (20) Cords & (7) Adapters *(shown above)*
(1) Carrying Case *(not shown)*

KIT FTR UPN #

FOTC-KIT

Cords can also be ordered separately in a variety of lengths & colors

150 Cooper Rd. (F-15)
W. Berlin, NJ 08091

www.tagcords.com

Telecom Assistance Group

Telephone: (856) 753-8585

Fax: (856) 768-7645

Fiber Optic Test Cord Kit 2

FOTC-KIT2

Fiber Optic Test Cords Included in Kit 2:

Carrying Case included with Kit



(2) 430773UAM-03
SC/APC to LC/UPC, Singlemode Simplex, 3.0mm yellow, Test Cord, 3 Meters



(2) 430766AAM-03
SC/APC to SC/APC, Singlemode Simplex, 3.0mm yellow, Test Cord, 3 Meters



(2) 430773AAM-03
SC/APC to LC/APC, Singlemode Simplex, 3.0mm yellow, Test Cord, 3 Meters



(2) 430766AM-03
SC/APC to SC/UPC, Singlemode Simplex, 3.0mm yellow, Test Cord, 3 Meters



(2) 430779AM-03
SC/APC to ST/UPC, Singlemode Simplex, 3.0mm yellow, Test Cord, 3 Meters



(2) 430770AM-03
SC/APC to FC/UPC, Singlemode Simplex, 3.0mm yellow, Test Cord, 3 Meters



(2) 430778AM-03
SC/APC to D4/UPC, Singlemode Simplex, 3.0mm yellow, Test Cord, 3 Meters

Fiber Optic Adapters Included in Kit 2:

- | | | | |
|--|---|--|---|
| (1) 400766C
SC to SC
Simplex
UPC Coupler | (1) 400766AC
SC to SC
Simplex
APC Coupler | (1) 400781C
LC to LC
Simplex
UPC Coupler | (1) 400781AC
LC to LC
Simplex
APC Coupler |
|--|---|--|---|



- (1) 400758C**
ST to ST
Simplex
UPC Coupler



- (1) 400752C**
FC to FC
Simplex
UPC Coupler



- (1) 400756C**
D4 to D4
Simplex
UPC Coupler



Ordering Information:

Fiber Optic Test Cord Kit 2
includes: **(14)** Cords & **(7)** Adapters *(shown above)*
(1) Carrying Case *(not shown)*

KIT FTR UPN #
FOTC-KIT2

Cords can also be ordered separately in a variety of lengths & colors

150 Cooper Rd. (F-15)
W. Berlin, NJ 08091

www.tagcords.com
Telecom Assistance Group

Telephone: (856) 753-8585
Fax : (856) 768-7645

TAG Fiber Streakers

**Fiber Streakers
for 2.5mm (TFS-208)
& 1.25mm (TFS-210)
Connectors - Including
SC, ST, FC & LC**

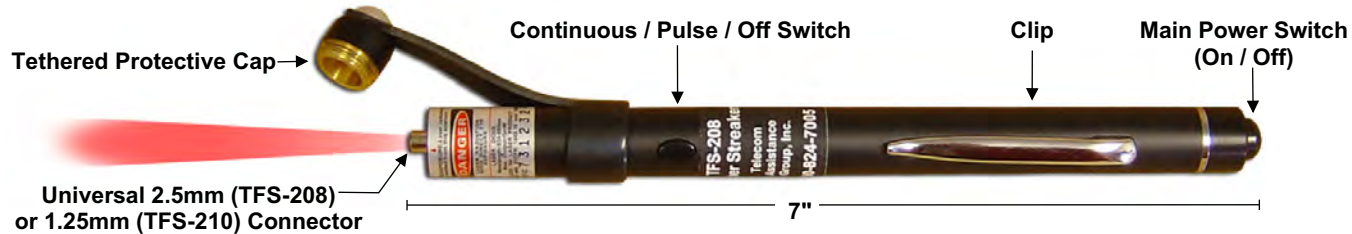

- ▶ Available with 2.5mm (TFS-208) & 1.25mm (TFS-210) receptacles for singlemode and multimode fibers
- ▶ The TFS-208 accepts any connector with a 2.5mm ferrule including SC, ST & FC connectors
- ▶ The TFS-210 accepts any connector with a 1.25mm ferrule including LC connectors
- ▶ Continuous and pulsed operation modes ▶ High visibility up to 3 km ▶ 650 nm laser output

Ordering Information:

Tag Fiber Streaker (2.5mm) - includes: (1) carrying case & (2) AAA batteries
Tag Fiber Streaker (1.25mm) - includes: (1) carrying case & (2) AAA batteries

FTR UPN #

TFS-208
TFS-210

150 Cooper Rd. (F-15)
 W. Berlin, NJ 08091

www.tagcords.com
Telecom Assistance Group

Telephone: (856) 753-8585
 Fax: (856) 768-7645

Portable "C" HDSL Powering Unit & Portable "R" Unit Kit

FTR UPN #
KIT-RHPCR
Portable "C" & "R" Kit

The Kit Includes:

(1) # PHTUC-01
Portable "C" -
HDSL Powering Test Unit

(1) # T-RHDSL
Portable "R" -
HDSL Test Unit



(card not included)

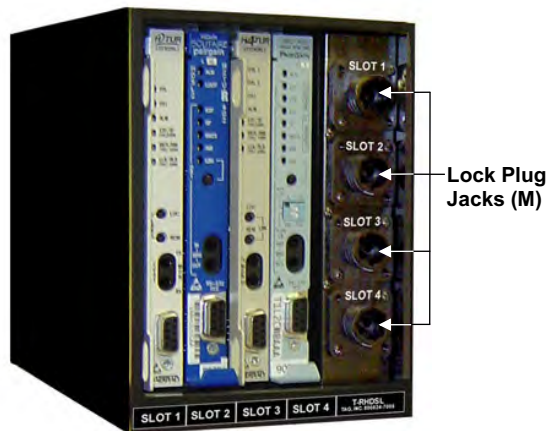

(cards not included)

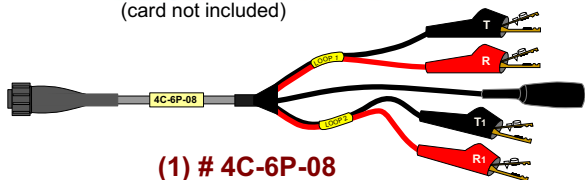

(1) # 4C-6P-08
Male Lock Plug to (4) 6P Alligator Clips
w/ GND, (8')

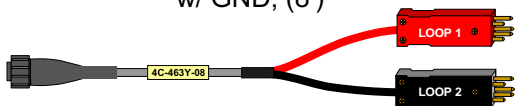

(1) # 4C-463Y-08
Male Lock Plug to 5 Pin "Y" Protector, (8')

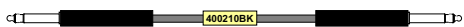

(1) # 400210BK
Bantam to Bantam Test Set Cord - Black, (6')

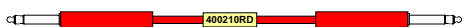

(1) # 400210RD
Bantam to Bantam Test Set Cord - Red, (6')

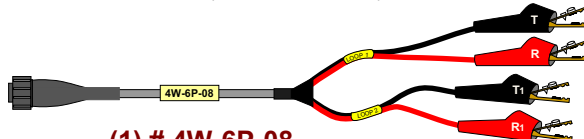

(1) # 4W-6P-08
Female Lock Plug to
(4) 6P Alligator Clips, (8')

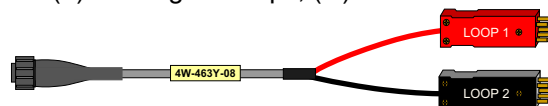

(1) # 4W-463Y-08
Female Lock Plug to
5 Pin "Y" Protector, (8')



Ordering Information:

Portable "C" HDSL Powering Unit & Portable "R" Unit Kit
includes: (1) PHTUC-01, (1) T-RHDSL, (1) 4C-6P-08, (1) 4C-463Y-08, (1) 400210RD,
(1) 400210BK, (1) 4W-6P-08, (1) 4W-463Y-08 & (2) Carrying Cases

KIT FTR UPN #
KIT-RHPCR

150 Cooper Rd. (F-15)
W. Berlin, NJ 08091

www.tagcords.com

Telephone: (856) 753-8585
Fax : (856) 768-7645

Telecom Assistance Group

Portable "C" - HDSL Test Unit Kit (3192 & 220)

FTR UPN #
PHTUC02-KIT01
 Portable "C" -
 HDSL Test Unit Kit
 (3192 & 220)

The Kit Includes:

(1) # PHTUC-02
 Portable HDSL
 Powering / Test Unit
 (3192 & 220 Cards)

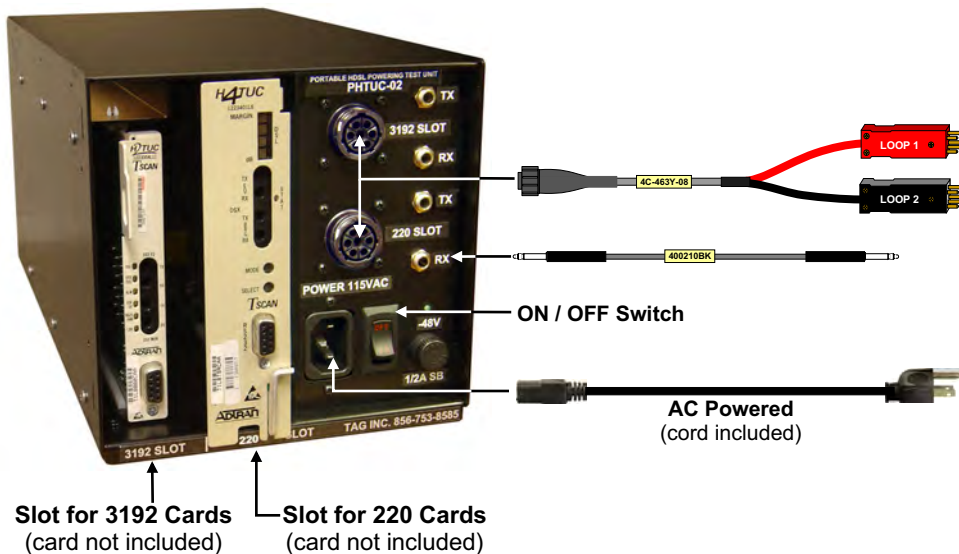

- ▶ **2 Slots (3192 & 220)**
- ▶ **Bantam Jacks for T1 Test Sets**
- ▶ **Isolates Troubles**
- ▶ **New Installs**



(1) # 600510
 Carrying Case
 Approx. Dimensions:
 14" (H) x 9" (L) x 7" (D)

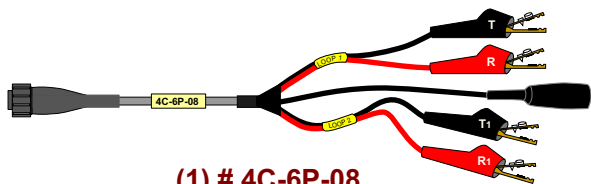

(1) # 4C-6P-08
 Male Lock Plug to (4) 6P Alligator Clips
 w/ GND, (8')

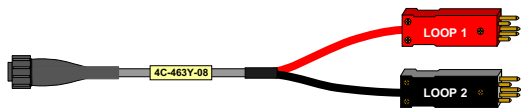

(1) # 4C-463Y-08
 Male Lock Plug to 5 Pin "Y" Protector, (8')

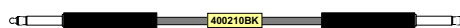

(1) # 400210BK
 Bantam to Bantam Test Set Cord - Black, (6')

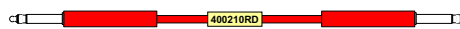

(1) # 400210RD
 Bantam to Bantam Test Set Cord - Red, (6')

Ordering Information:

Portable "C" - HDSL Test Unit Kit (3192 & 220)
 includes: (1) PHTUC-02, (1) 4C-463Y-08, (1) 4C-6P-08, (1) 400210RD,
 (1) 400210BK & (1) 600510 - Carrying Case

KIT FTR UPN #
PHTUC02-KIT01

150 Cooper Rd. (F-15)
 W. Berlin, NJ 08091

www.tagcords.com

Telephone: (856) 753-8585
 Fax: (856) 768-7645

Telecom Assistance Group

Portable "C" - HDSL Powering Test Unit Kit

The Kit Includes: (1) # PHTUC-01
Portable "C" -
HDSL Powering Test Unit
w/ AC Power Cord

FTR UPN # PHTUC-KIT01
Portable "C" -
HDSL Powering Test Unit Kit



1 Slot (2 & 4 Wire)
(3192 Mech. Card not included)

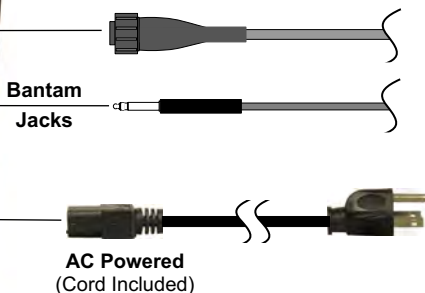

(1) # 600510
Carrying Case

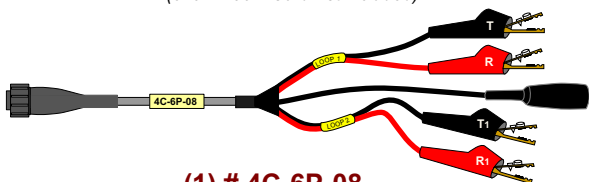

(1) # 4C-6P-08

Male Lock Plug to (4) 6P Alligator Clips w/ GND, (8')

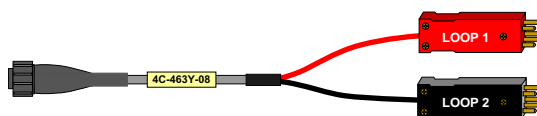

(1) # 4C-463Y-08

Male Lock Plug to 5 Pin "Y" Protector, (8')

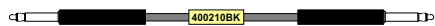

(1) # 400210BK

Bantam to Bantam Test Set Cord - Black, (6')

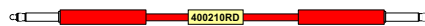

(1) # 400210RD

Bantam to Bantam Test Set Cord - Red, (6')

HDSL Application Diagram

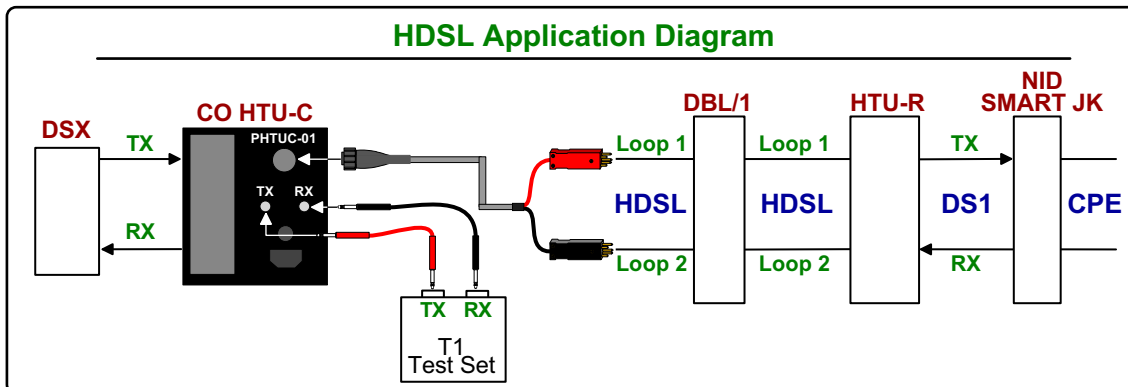

Ordering Information:

Portable "C" - HDSL Powering Test Unit Kit

includes: (1) PHTUC-01, (1) 4C-6P-08, (1) 4C-463Y-08, (1) 400210RD, (1) 400210BK & (1) 600510

Male Lock Plug to 5 Pin "Y" Protector, (8')

Male Lock Plug to (4) 6P Alligator Clips w/ GND, (8')

KIT FTR UPN #
PHTUC-KIT01

4C-463Y-08

4C-6P-08

150 Cooper Rd. (F-15)
W. Berlin, NJ 08091

www.tagcords.com

Telephone: (856) 753-8585
Fax: (856) 768-7645

Telecom Assistance Group

Portable "R" - HDSL Test Unit Kits

FTR UPN #
RHDSL-KIT4
Portable "R" -
HDSL Test Unit Kit



(1) # 600509
Carrying Case

(1) # 4W-A-08
Female Lock Plug to
(4) Alligator Clips, (8')

(1) # 4W-463Y-08
Female Lock Plug to
5 Pin "Y" Protector, (8')

Kit Includes: **(1) # T-RHDSL**
Portable "R" - HDSL Test Unit



(cards not included)

4W-A-08 →

- ▶ **4 Slots for 200/400 Mech. HDSL "R" Cards**
- ▶ **Rugged Connectors**
- ▶ **Various Test Cords**

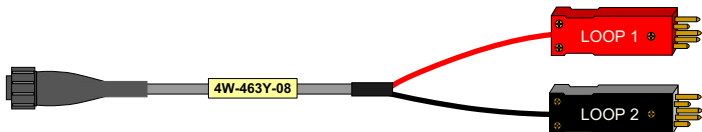
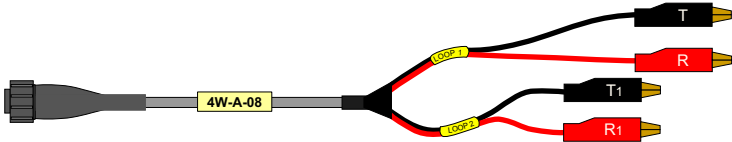

Ordering Information:

Portable "R" - HDSL Test Unit Kit (w/ standard alligators)
includes: (1) T-RHDSL, (1) 4W-A-08, (1) 4W-463Y-08 & (1) 600509

FTR UPN #
RHDSL-KIT4

Portable "R" - HDSL Test Unit Kit (w/ 6P alligators)
includes: (1) T-RHDSL, (1) 4W-6P-08, (1) 4W-463Y-08 & (1) 600509

RHDSL-BST01

Portable "R" - HDSL Test Unit (requires test cords)
Female Lock Plug to (4) Alligator Clips, (8')
Female Lock Plug to 5 Pin "Y" Protector, (8')
Female Lock Plug to (4) 6P Alligator Clips, (8') (not shown)
Carrying Case

T-RHDSL
4W-A-08
4W-463Y-08
4W-6P-08
600509

150 Cooper Rd. (F-15)
W. Berlin, NJ 08091

www.tagcords.com

Telephone: (856) 753-8585
Fax : (856) 768-7645

Telecom Assistance Group







SS7 Audit Kit

SS7-KIT

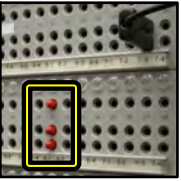
FTR UPN # SS7-KIT

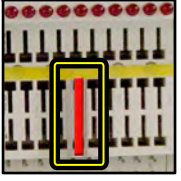

(SS7-KIT includes all contents shown below & carrying case)

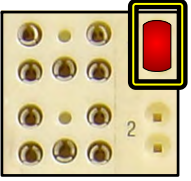
Dummy Plugs

QTY / PN # / DESC.	<i>(not to scale)</i>	
(20) # 310DP 310 Dummy Plug		
(20) # 210DP Bantam Dummy Plug	 FTR UPN # 210DP-KIT50 (QTY of 50)	
(8) # 800DP 800 DSX Dummy Plug		
(10) # 453ADP 453A Dummy Plug		





- Plugs into vacant 310 (PN # 310DP), bantam (PN # 210DP), 800 DSX (PN # 800DP) or 453A (PN # 453ADP) jacks
- Used to prevent accidental insertion / disruption of the circuit
- Identifies special circuits (i.e. SS7 circuits)

Protective Caps

QTY / PN #	Description	<i>(not to scale)</i>
(50) # SS7-2P	SS7 2 Pin Cap (1/2)	
(50) # SS7-3P	SS7 3 Pin Cap (5/8)	
(24) # SS7-6P	SS7 6 Pin Cap (1 3/8)	

- Placed over wire wrap terminals at MDF Frames
- Identifies special circuits (i.e. SS7 circuits)

Labels & Tags

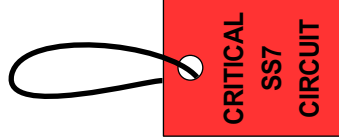
FTR UPN #	Description / QTY	<i>(approx. size)</i>
# SS7-LB1	SS7 Labels, (SM) (QTY of 50)	
# SS7-LB2	SS7 Labels, Rectangle (SM) (QTY of 50)	
# SS7-LB3	SS7 Labels, Rectangle (LG) (QTY of 25)	
# SS7-LBL3B	SS7 Labels, Rectangle (XLG) (QTY of 25)	
# SS7-TAG	SS7 Threaded Tag (QTY of 50)	

150 Cooper Rd. (F-15)
W. Berlin, NJ 08091

www.tagcords.com

Telecom Assistance Group

Telephone: (856) 753-8585
Fax: (856) 768-7645

DMS-10/100 Pre-Charge Tool

T-DMSTBT

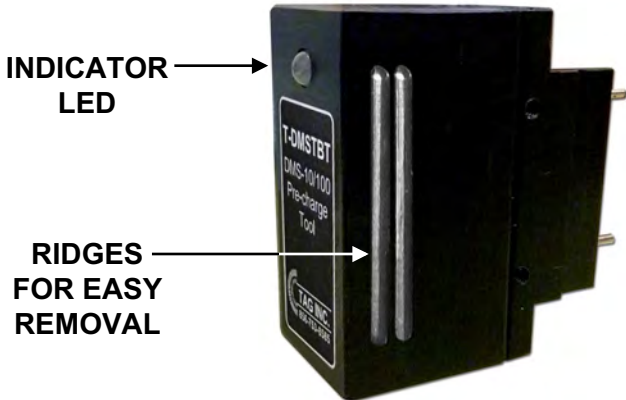

FTR UPN # T-DMSTBT
DMS-10/100
 Pre-Charge Tool

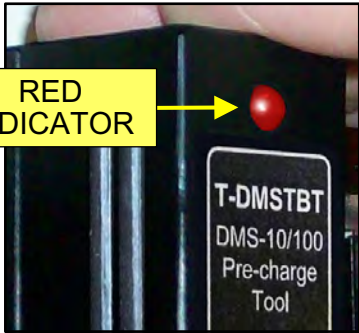

- THE INDICATOR GOES OUT WHEN IT IS SAFE TO INSTALL THE FUSE (APPROX. 10 SEC).
- IF THE INDICATOR STAYS LIT, THERE IS A LOAD OR FAULT ON THE CIRCUIT.

Application:

TAG's # T-DMSTBT is used to pre-charge shelf power capacitors on a DMS-10/100 switch. This allows a new fuse to be installed without seeing full in-rush surge current. The indicator light goes out when it is safe to install the fuse.

Ordering Information:

DMS-10/100 Pre-Charge Tool

FTR UPN #
T-DMSTBT

150 Cooper Rd. (F-15)
 W. Berlin, NJ 08091

www.tagcords.com

Telephone: (856) 753-8585
 Fax : (856) 768-7645

Telecom Assistance Group

New Replacement Dumb Terminals - Transport / DACS Equipment

NEW TERMINAL WORKS ON
Titan 5500, CS1, CS1L, DACS II, III, IV, Alcatel 1631 & HDSL
(Titan 5500 shown below)

REMOVE & REPLACE OLD / BROKEN CRTs

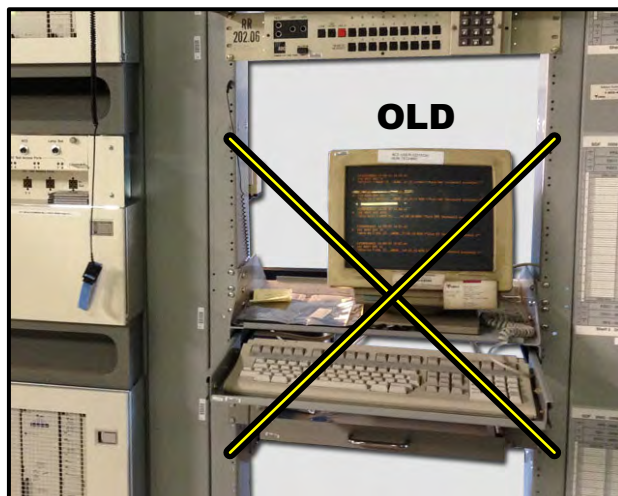

SPECIFICATIONS

- VT-100 COMPATIBLE
- SINGLE RS-232 INPUT
- PRINTER OUTPUT
- LOW POWER

Printer Port Type:



Parallel **

** If a Serial Port is needed, please order a Parallel to Serial Adapter (Part # TT-PSA). Please call 856-753-8585 for more information.

Ordering Information:

TAG Replacement Single Session Dumb Terminal

includes: (1) 17" Flat Screen Monitor, (1) Keyboard,
 (1) Single Session Terminal Controller,
 (1) # 400701, DB25M Gender Changer & (1) Quick Guide

FTR UPN

TT-VT100S

150 Cooper Rd. (F-15)
 W. Berlin, NJ 08091

www.tagcords.com

Telephone: (856) 753-8585
 Fax : (856) 768-7645

Telecom Assistance Group

DMS Terminal Replacements - Single Session

Model:

TT-SCAP-DMSKIT

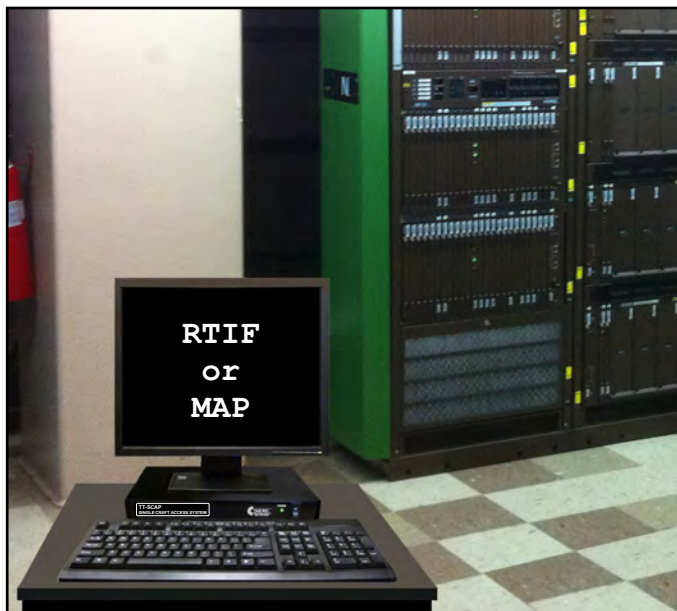

Kit Includes (TT-SCAP-DMSKIT):

- (1) 17" Flat Screen Monitor
- (1) Dumb Terminal Controller
- (1) Keyboard
- (1) Quick Guide
- (1) 400700,
(DB25F Gender Changer) 
- (1) 400725SB2,
(DMS Quick Connect Current Loop Adapter Cable w/ DEC Connector)



SPECIFICATIONS

- VT-100 COMPATIBLE
- SINGLE RS-232 INPUT
- PRINTER OUTPUT
- LOW POWER

Printer Port Type:



Parallel *

* If a Serial Port is needed, please order a Parallel to Serial Adapter (PN # TT-PSA). Call 856-753-8585 for more information.

Ordering Information:

Single Craft Access System - DMS (Kit 1)

includes: (1) 17" Flat Screen Monitor, (1) Keyboard,
(1) Single Session Dumb Terminal Controller, (1) Quick Guide,
(1) # 400700 (DB25F Gender Changer) &
(1) # 400725SB2 (DMS Quick Connect Current Loop Adapter Cable w/ DEC Connector)

FTR UPN #

TT-SCAP-DMSKIT

Single Craft Access System - DMS (Kit 2)

includes: (1) 17" Flat Screen Monitor, (1) Keyboard,
(1) Single Session Dumb Terminal Controller, (1) Quick Guide,
(1) # 400700 (DB25F Gender Changer) &
(1) # 400725SB2 (DMS Quick Connect Current Loop Adapter Cable w/ DEC Connector)
(1) # 400725SBW** (Hardwire Adapter for 400725SB2) **not shown

TT-SCAP-DMSKIT2

Replacement Power Pack for DMS Terminal, 5VDC (not shown)

TT-DCA5-PP

150 Cooper Rd. (F-15)
W. Berlin, NJ 08091

www.tagcords.com

Telephone: (856) 753-8585
Fax : (856) 768-7645

Telecom Assistance Group

DMS Terminal Replacements - Dual Session

Model:

TT-DCAP-DMSKIT



Kit Includes:

- (1) 17" Flat Screen Monitor
- (1) Dumb Terminal Controller
- (1) Keyboard
- (1) Quick Guide
- (2) 400700, (DB25F Gender Changer) 
- (2) 400725SB2, (DMS Quick Connect Current Loop Adapter Cable w/ DEC Connector)



SPECIFICATIONS

- VT-100 COMPATIBLE
- DUAL RS-232 INPUTS
- PRINTER OUTPUT
- LOW POWER

Printer Port Type:



Parallel * * If a Serial Port is needed, please order a Parallel to Serial Adapter (PN # TT-PSA). Call 856-753-8585 for more information.

Ordering Information:

Dual Craft Access System - DMS Kit

includes: (1) 17" Flat Screen Monitor, (1) Keyboard,
 (1) Dual Session Dumb Terminal Controller, (1) Quick Guide,
 (2) # 400700 (DB25F Gender Changer) &
 (2) # 400725SB2 (DMS Quick Connect Current Loop Adapter Cable w/ DEC Connector)

FTR UPN #

TT-DCAP-DMSKIT

Replacement Power Pack for DMS Terminal, 5VDC (not shown)

TT-DCA5-PP

150 Cooper Rd. (F-15)
 W. Berlin, NJ 08091

www.tagcords.com

Telephone: (856) 753-8585
 Fax : (856) 768-7645

Telecom Assistance Group

5ESS MCC / ROP Terminal

TAG offers a New Feature on our 5ESS MCC Dumb Terminal, The "Glass Printer" Feature

REMOVE & REPLACE OLD / BROKEN CRTs & PRINTERS

OLD



NEW

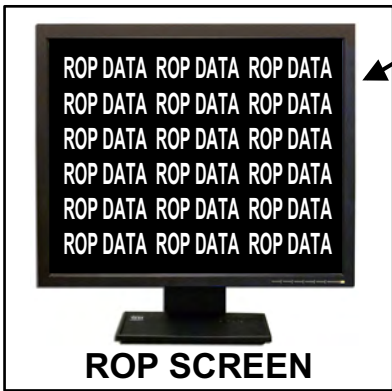
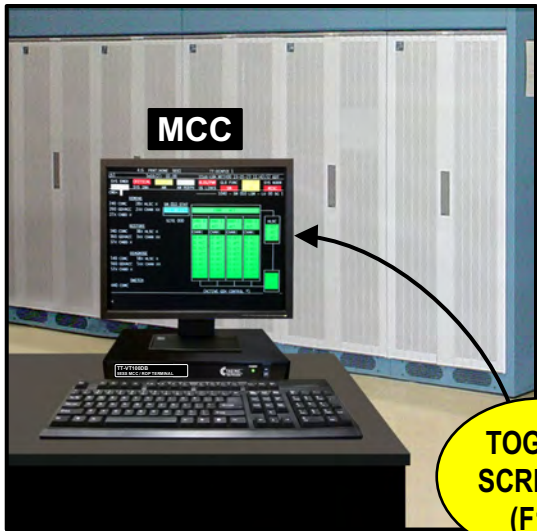

TOGGLE SCREENS (F12)

new label on the keyboard above the F12 key



SPECIFICATIONS

- VT-100 COMPATIBLE
- LOW POWER
- AUTO-BAUD

Ordering Information:

5ESS MCC / ROP Terminal

includes: (1) 17" Flat Screen Monitor, (1) Keyboard,
 (1) MCC Terminal Controller w/ ROP Glass Printer & Auto Baud Feature,
 (2) # 400701, DB25M Gender Changers & (1) Quick Guide

FTR UPN #
TT-VT100DB

150 Cooper Rd. (F-15)
 W. Berlin, NJ 08091

www.tagcords.com

Telephone: (856) 753-8585
 Fax : (856) 768-7645

Telecom Assistance Group

5ESS Terminal Replacements - Single Session

Model:

TT-SCAPCE



Includes:

- (1) 17" Flat Screen Monitor
- (1) Dumb Terminal Controller
- (1) Keyboard
- (1) Quick Guide
- (1) 400701,
(DB25M Gender Changer)



SPECIFICATIONS

- VT-100 COMPATIBLE
- SINGLE RS-232 INPUT
- PRINTER OUTPUT
- LOW POWER

Printer Port Type:



Parallel * * If a Serial Port is needed, please order a Parallel to Serial Adapter (PN # TT-PSA). Call 856-753-8585 for more information.

Ordering Information:

Single Craft Access System - 5ESS

includes: (1) 17" Flat Screen Monitor, (1) Keyboard,
(1) Single Session Dumb Terminal Controller, (1) Quick Guide &
(1) # 400701 (DB25M Gender Changer)

FTR UPN

TT-SCAPCE

Replacement Power Pack for 5ESS Terminal, 5VDC (not shown)

TT-DCA5-PP

150 Cooper Rd. (F-15)
W. Berlin, NJ 08091

www.tagcords.com

Telephone: (856) 753-8585
Fax : (856) 768-7645

Telecom Assistance Group

5ESS Terminal Replacements - Dual Session

Model:

TT-DCAPCE



Includes:

- (1) 17" Flat Screen Monitor
- (1) Dumb Terminal Controller
- (1) Keyboard
- (1) Quick Guide
- (2) 400701,
(DB25M Gender Changer)



SPECIFICATIONS

- VT-100 COMPATIBLE
- DUAL RS-232 INPUTS
- PRINTER OUTPUT
- LOW POWER

Printer Port Type:



Parallel * ** If a Serial Port is needed, please order a Parallel to Serial Adapter (PN # TT-PSA). Call 856-753-8585 for more information.*

Ordering Information:

Dual Craft Access System - 5ESS

includes: (1) 17" Flat Screen Monitor, (1) Keyboard,
(1) Dual Session Dumb Terminal Controller, (1) Quick Guide &
(2) # 400701 (DB25M Gender Changer)

FTR UPN

TT-DCAPCE

Replacement Power Pack for 5ESS Terminal, 5VDC (not shown) TT-DCA5-PP

150 Cooper Rd. (F-15)
W. Berlin, NJ 08091

www.tagcords.com

Telephone: (856) 753-8585
Fax : (856) 768-7645

Telecom Assistance Group

GTD5 Terminal Replacements - Dual Session

Model:

TT-DCAG5

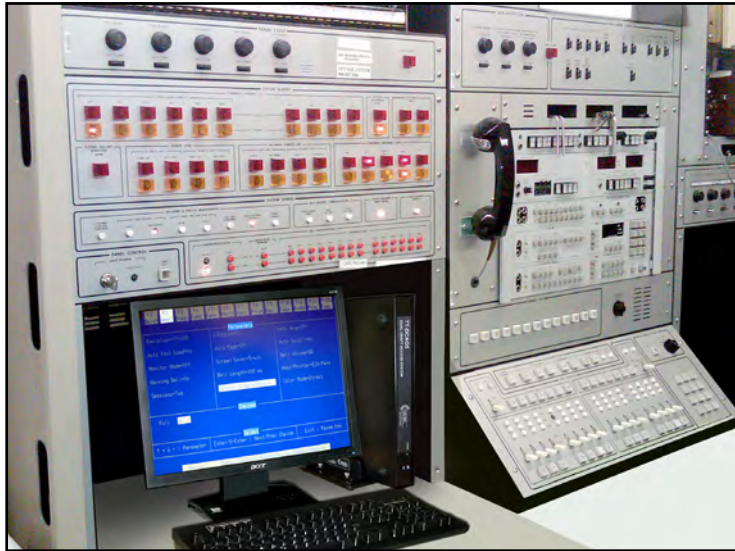

Includes:

- (1) 17" Flat Screen Monitor**
- (1) Dumb Terminal Controller**
- (1) TT-MTG5**
(Vertical Mounting Kit)
- (1) Keyboard**
- (1) Quick Guide**
- (2) 400701,**
(DB25M Gender Changer)



SPECIFICATIONS

- VT-100 COMPATIBLE
- DUAL RS-232 INPUTS
- PRINTER OUTPUT
- LOW POWER

Printer Port Type:



↑
Parallel *

* If a Serial Port is needed, please order the KIT -
(UPN # TT-DCAG5-KIT1) which includes a Parallel to
Serial Adapter (PN # TT-PSA).

Ordering Information:

Dual Craft Access System - GTD5

includes: (1) 17" Flat Screen Monitor, (1) Keyboard,
(1) Dual Session Dumb Terminal Controller, (1) Quick Guide,
(1) # TT-MTG5 (Vertical Mounting Kit) &
(2) # 400701 (DB25M Gender Changer)

FTR UPN #
TT-DCAG5

Dual Craft Access System - GTD5 Kit

includes: (1) 17" Flat Screen Monitor, (1) Keyboard,
(1) Dual Session Dumb Terminal Controller, (1) Quick Guide,
(1) # TT-MTG5 (Vertical Mounting Kit),
(2) # 400701 (DB25M Gender Changer) &
(1) # TT-PSA** (Parallel to Serial Printer Adapter w/ AC Power Pack) **not shown

TT-DCAG5-KIT1

Replacement Power Pack for GTD5 Terminal, 5VDC (not shown)

TT-DCA5-PP

150 Cooper Rd. (F-15)
W. Berlin, NJ 08091

www.tagcords.com

Telephone: (856) 753-8585
Fax : (856) 768-7645

Telecom Assistance Group

Siemens EWSD OMT* Terminal Replacements



Model:

TT-DCAOMT

(1) 17" Flat Screen Monitor

(1) EWSD® OMT® Controller

(1) Keyboard

(1) TT-MOUSEPS
(Optical Mouse)

(1) 400700
(DB25F Gender Changer)

Back of Terminal Controller:



Ordering Information:

Siemens EWSD OMT Craft Access System

includes: (1) 17" Flat Screen Monitor, (1) Keyboard, (1) EWSD OMT Controller,
(1) # TT-MOUSEPS & (1) # 400700

Replacement Power Pack for EWSD Terminal, 5VDC

FTR UPN

TT-DCAOMT

TT-DCA5-PP

150 Cooper Rd. (F-15)
W. Berlin, NJ 08091

www.tagcords.com

Telephone: (856) 753-8585
Fax : (856) 768-7645

Telecom Assistance Group

Frontier Approved (MO Drive) - NEBS Certified - Siemens EWSD Disk Drive Solutions from TAG

**SIEMENS EWSD w/ EXISTING DRIVES
MAGNETO-OPTICAL (MO) & HARD DISK (HDD)
(w/ "MOVING PARTS")**

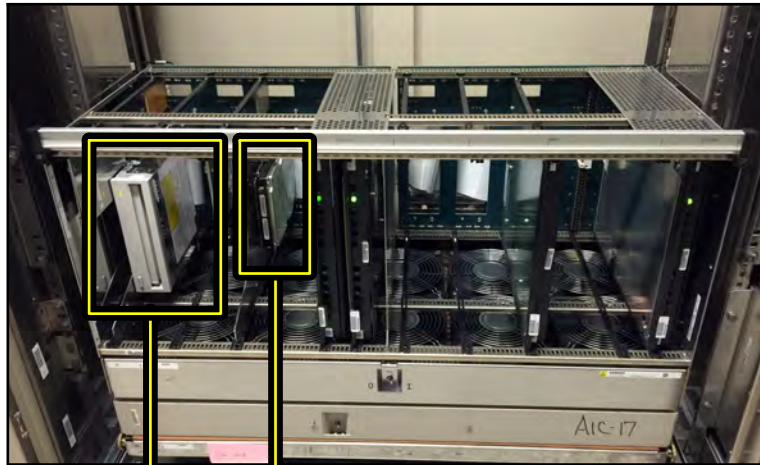

HARD DISK (HDD)

MAGNETO-OPTICAL (MO)

NEW SOLID STATE DRIVES FROM TAG

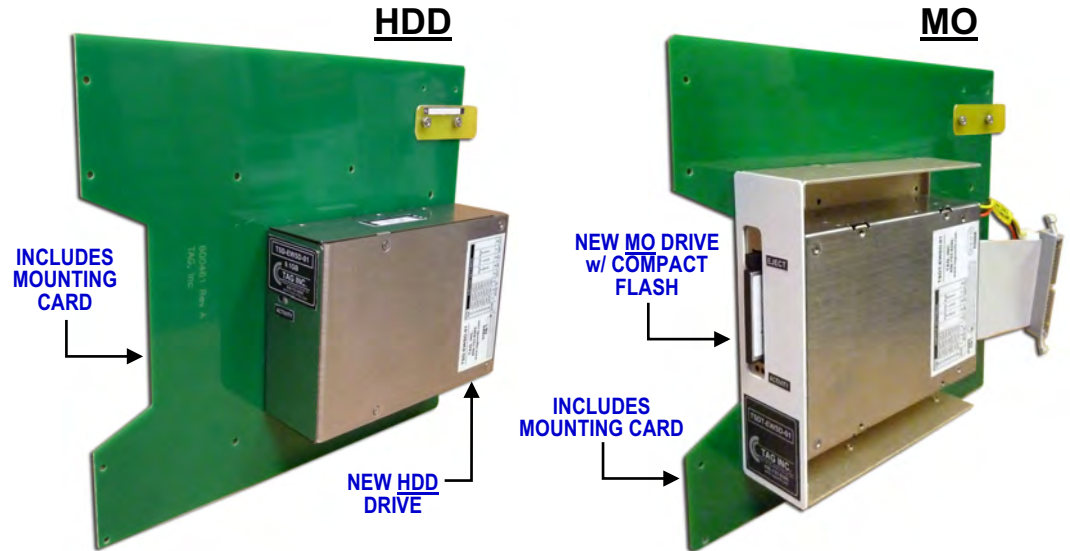

NEW SOLID STATE DRIVES AVAILABLE FROM TAG

TAG MODEL #	USED IN SIEMENS EWSD HDD MODULE (HECI EQMYAE0DAA)	
TSD-EWSD-01* *(call for pricing)	Solid State Replacement for: Siemens EWSD Module # S30807-U2594-X300 (HECI EQMYAE0DAA) Hard Disk Drive (HDD) w/ Mounting (S30122-U789-X-2 (ST-39173N))	9.1Gb
FTR UPN #	USED IN SIEMENS EWSD MO DRIVE MODULE (HECI EGM8JF0BRA)	
TSDT-EWSD-01	Solid State Replacement for: Siemens EWSD Module # S30807-U2593-X200 (HECI EGM8JF0BRA) Magneto-Optical (MO) Drive w/ Mounting (S30122-U563-X400) <i>Includes: 4Gb Industrial Compact Flash Card (PN # TSD-CF-04**)</i>	4Gb
** Additional Compact Flash Cards are Available: 4Gb (FTR UPN # TSD-CF-04) , 8Gb (PN # TSD-CF-08), 16Gb (PN # TSD-CF-16)		

Application:

TAG can **REPLACE** failing / broken Siemens EWSD Magneto-Optical (MO) & Hard Disk (HDD) Drives with **NEW** Solid State Drives.

150 Cooper Rd. (F-15)
W. Berlin, NJ 08091

www.tagcords.com

Telecom Assistance Group

Telephone: (856) 753-8585

Fax : (856) 768-7645

Frontier Approved - NEBS Certified - 5ESS Solid State Drive Solutions from TAG

5ESS SWITCH w/ EXISTING DRIVES
(w/ "MOVING PARTS")

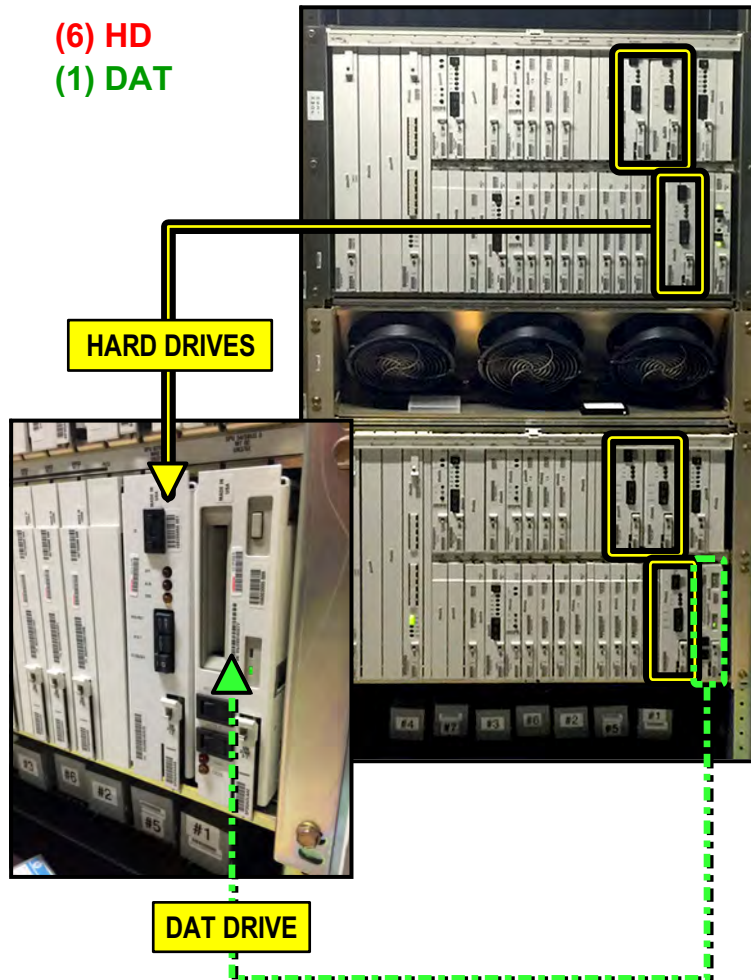

NEW SOLID STATE DRIVES FROM TAG

NEW HARD DRIVE



NEW DAT DRIVE w/ COMPACT FLASH

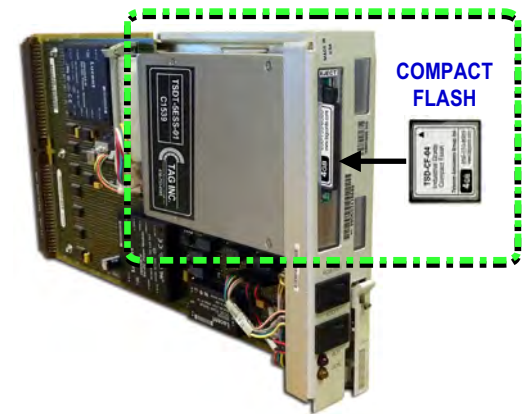

Application:

TAG can **REPLACE** failing / broken 5ESS Hard Drives & DAT Drives with **NEW** Solid State SCSI Drives.

FTR UPN #	USED ON UN375E AND UN375F CIRCUIT PACKS (HD)	
TSD-5ESS-01	Solid State Replacement for: Hard Drive , HECI code SP3QADRAAA (typical), KS-23908 QUANTUM 3.5 INCH SCSI	9.1 Gb

FTR UPN #	USED ON UN376E AND UN376F CIRCUIT PACKS (DAT)	
TSDT-5ESS-01	Solid State Replacement for: DAT Drive , C1539, HECI code SP3QADLAAC (typical), <i>Includes: 4Gb Industrial Compact Flash Card (FTR UPN # TSD-CF-04*)</i>	4 Gb

* Additional Compact Flash Cards are Available:
4Gb (FTR UPN # **TSD-CF-04**), 8Gb (PN # TSD-CF-08), 16Gb (PN # TSD-CF-16)

150 Cooper Rd. (F-15)
W. Berlin, NJ 08091

www.tagcords.com
Telecom Assistance Group

Telephone: (856) 753-8585
Fax : (856) 768-7645

Frontier Approved - NEBS Certified - Stromberg Carlson DCO Drive Solutions from TAG

**DCO MSDA 822010 CIRCUIT PACKS
w/ EXISTING HARD DRIVE & TAPE DRIVE (w/ "MOVING PARTS")**

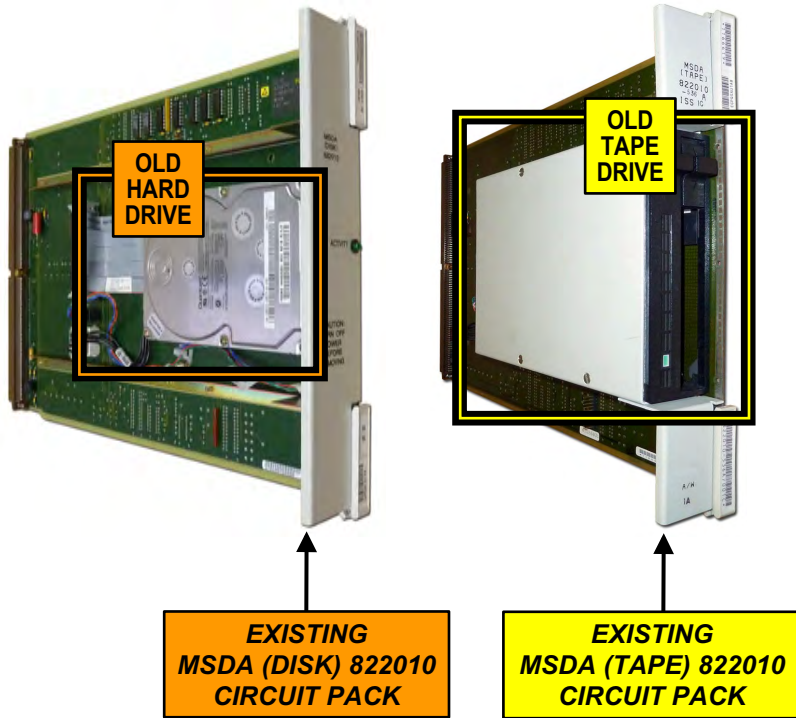

**NEW SOLID STATE DRIVES FROM TAG
(INSTALLED ON EXISTING CIRCUIT PACKS)**

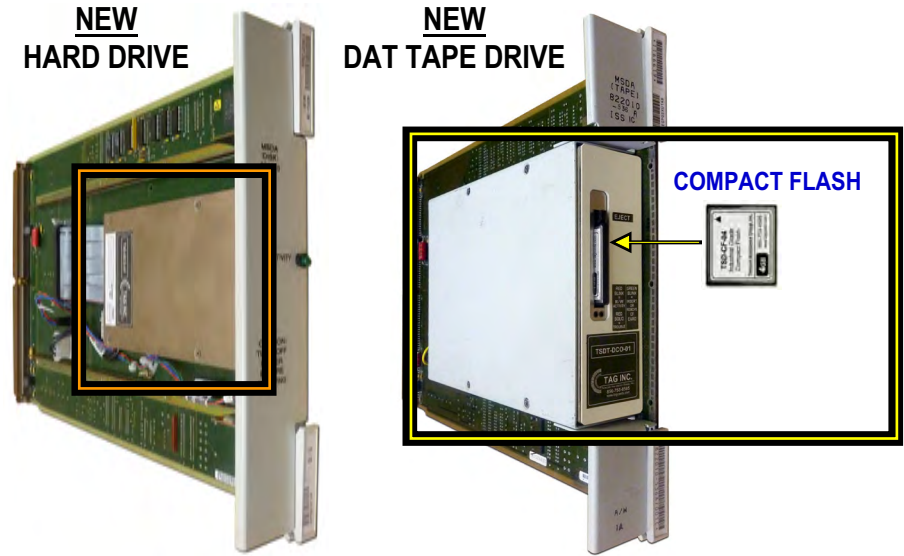

Application:

TAG can **REPLACE** older or failing Hard (Disk) Drives & DAT Tape Drives on existing Stromberg Carlson DCO, MSDA 822010 circuit packs with **NEW** Solid State Drives.

FTR UPN #	USED ON EXISTING MSDA (DISK) 822010 CIRCUIT PACK
TSD-DCO-01	Solid State Replacement Hard Drive used on: Stromberg Carlson DCO, MSDA (DISK) 822010-706, 4.5Gb
TSD-DCO-02	Solid State Replacement Hard Drive used on: Stromberg Carlson DCO, MSDA (DISK) 822010-716, 9Gb
FTR UPN #	USED ON EXISTING MSDA (TAPE) 822010 CIRCUIT PACK
TSDT-DCO-01	Solid State Replacement DAT Tape Drive used on: Stromberg Carlson DCO, MSDA (TAPE) 822010, HECI: EGQXSU1AB (typical) <i>Includes: 4Gb Industrial Compact Flash Card (FTR UPN # TSD-CF-04)</i>
TSDT-DCO-02	Solid State Replacement DAT Tape Drive used on: Stromberg Carlson DCO, MSDA (TAPE) 822010-726 <i>Includes: 4Gb Industrial Compact Flash Card (FTR UPN # TSD-CF-04)</i>

Additional Compact Flash Cards are Available: **4Gb (FTR UPN # TSD-CF-04)**, 8Gb (# TSD-CF-08), 16Gb (# TSD-CF-16)

150 Cooper Rd. (F-15)
W. Berlin, NJ 08091

www.tagcords.com
Telecom Assistance Group

Telephone: (856) 753-8585
Fax: (856) 768-7645

5ESS Replacement Fans

- ▶ All TAG Fans are **NEW** (No Refurbs)
- ▶ Exact Drop-in Replacements
- ▶ 48V $\overline{\text{DC}}$ 0.40A

DON'T SEE THE FAN YOU NEED?

**Send us a Sample
& we will Find a Match!**



KS22501L3 Models:

FTR UPN # TF-5ESS-01F
5ESS Replacement Fan
w/ 3 Leads &
Faston Connectors
(fan w/ power prongs)



FTR UPN # TF-5ESS-01P
5ESS Replacement Fan
w/ 3 Leads &
AMP Connector
(fan w/ power prongs)



DC Fan Power Cords are available for KS22501L3 type fans
(order TAG MODEL # TF-DCPWR-01)



(connect to power prongs on KS22501L3 type fans)

KS23912L2 Model:

FTR UPN # TF5ESS03P
5ESS Replacement Fan
w/ 4 Leads & AMP Connector



KS22501L3A Models:

FTR UPN # TF-5ESS-04F
5ESS Replacement Fan
w/ 5 Leads & Faston Connectors



FTR UPN # TF-5ESS-04P
5ESS Replacement Fan
w/ 5 Leads & AMP Connector



KS23912L1A Models:

FTR UPN # TF-5ESS-02F
5ESS Replacement Fan
w/ 5 Leads & Faston Connectors
w/ Internal Thermal Speed Control Sensor



FTR UPN # TF-5ESS-02P
5ESS Replacement Fan
w/ 5 Leads & AMP Connector
w/ Internal Thermal Speed Control Sensor



KS23398L2 Model:

FTR UPN # TF-5ESS-10P
ISLU (Square Fan)
48V $\overline{\text{DC}}$ 0.13A
w/ 5 Leads &
AMP Connector

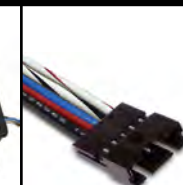

150 Cooper Rd. (F-15)
W. Berlin, NJ 08091

www.tagcords.com

Telephone: (856) 753-8585
Fax : (856) 768-7645

Telecom Assistance Group

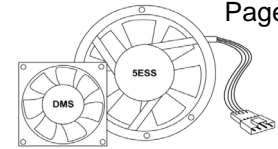

Part #	Description	FTR UPN #
5ESS FANS		
TF-5ESS-01P	KS22501L3 Equiv. 5ESS Fan w/ 3 Leads & AMP Conn. (w/ power prongs)	TF-5ESS-01P
TF-5ESS-01F	KS22501L3 Equiv. 5ESS Fan w/ 3 Leads & Fastons (w/ power prongs)	TF-5ESS-01F
TF-5ESS-02P	KS23912L1A Equiv. 5ESS Fan w/ 5 Leads & AMP Connector (w/ Internal Thermal Speed Control Sensor)	TF-5ESS-02P
TF-5ESS-02F	KS23912L1A Equiv. 5ESS Fan w/ 5 Leads & Faston Connectors (w/ Internal Thermal Speed Control Sensor)	TF-5ESS-02F
TF-5ESS-03P	KS23912L2 Equiv. 5ESS Fan w/ 4 Leads & AMP Connector	TF5ESS03P
TF-5ESS-04P	KS22501L3A Equiv. 5ESS Fan w/ 5 Leads & AMP Connector	TF-5ESS-04P
TF-5ESS-04F	KS22501L3A Equiv. 5ESS Fan w/ 5 Leads & Faston Connectors	TF-5ESS-04F
TF-5ESS-10P	KS23398L2 Equiv. 5ESS ISLU (Square Fan) w/ 5 Leads & AMP Connector	TF-5ESS-10P
ADTRAN FANS		
TF-TA3000-01	Adtran TA3000 , 48V Fan w/ 3 Wire Plug (for HECI: M3PQ0AV, 1181006L1)	
TF-TA5K-01	Adtran TA5000 , 48V Fan w/ 4 Wire Plug	TF-TA5K-01
TF-TA5K-02	Adtran TA5000 , 48V Fan w/ 3 Wire Plug	TF-TA5K-02
ALCATEL FANS		
TF-ALC-01	Alcatel 1000/7300 , 48V Fan w/ Tach & 3 Wire Plug (3EC 15478, 3EC 37933 & 3EC 36760)	TF-ALC-01
TF-AL7300-02	Alcatel 7300 , 48V Fan w/ Internal Sensor, Tach & 3 Wire Plug (use in 3EC 16697 (XXXX))	TF-AL7300-02
TF-DSCECS1-01	DSC / Alcatel ECS1 , 48V Fan w/ 3 Wire Plug	TF-DSCECS1-01
TF-ALC1603-01	Alcatel 1603 , 48V Fan w/ 3 Wire Plug (use in Low-Volume Fan Tray # 625052-000-0XX)	
TF-ALC1631-01	Alcatel 1631 , 48V Fan (Square) w/ Power Prongs (use in Assembly # 695-3363-302)	TF-ALC1631-01
TF-ALC1631-02	Alcatel 1631 , 48V Fan (Round) w/ Power Prongs & Tach Lead (use in #3AL45446AA)	TF-ALC1631-02
TF-ALC1631-03	Alcatel 1631 APS , 48V Fan (Square) w/ Pwr Prongs & Tach Lead (use in #695-8489-001)	
TF-ALC1680-01	Alcatel 1680 OGX , 48V Fan (Round) w/ Pwr Prongs & Tach Lead (use in #3EM04820AA)	
BIGBAND / ADC FANS		
TF-BIGBND-01	BigBand , 12V w/ 3 Wire Open End Fan (w/ Speed Control)	TFBIGBND01
TF-BIGBND-03SR	BigBand Shelf / Door Repair	
TF-BIGBPS-01	12V Fan (40mm) for BigBand (FTTP bays) & ADC RF Worx Power Supplies	TF-BIGBPS-01
CIENA FANS		
TF-CN1600-01	Ciena 1600 DWDM , 48V Fan (fan only, mounting bracket is not included)	
TF-DN7100-01	Ciena DN7100 , 12V Fan w/ 3 Wire Plug (TA225DC Equiv.)	TF-DN7100-01
TF-DN7100-02	Ciena DN7100 , 12V Fan w/ 3 Wire Plug (TA300DC Equiv.)	TF-DN7100-02
CISCO 15454 / GTD-5 / KENTROX FANS		
TF-C15454-01	Cisco ONS 15454 , 48V Fan w/ 3 Wire Right Angle Connector	TF-C15454-01
TF-GTD5-01	GTD-5 , 48V Fan w/ 5 Wire Plug	TF-GTD5-01
TF-GTD5AG-01	GTD-5 AG Communications Unit , 48V Fan (60x25mm) w/ 3 Wire Plug	
TF-AI-180	Kentrox AISwitch Series 180 , 48V Cooling Fan w/ 3 Wire Right Angle Connector	
CALIX / FUJITSU / DATAKIT / GALAXY RECTIFIER FANS		
TF-CLXE7-01	12V (40mm x 20mm) Fan for Calix E7-2 FTA2 Fan Unit w/ 4 Wire Plug	
TF-FW4500-01	48V Fan for Flashwave 4500 Fan Unit w/ 4 Wire Plug	
TF-FLM150-01	48V (80mm) Fan for Fujitsu FLM 150 Fan Tray w/ 3 Wire Plug	TF-FLM150-01
TF-DATAKIT-01	24V Fan for Datakit System w/ 3 Wire, 4 Pin Connector	
TF-GLX595LTB-01	48V Fan for Galaxy 595LTB Rectifier w/ 4 Wire Plug	
LORAIN / MARCONI RECTIFIER FANS		
TFT-MRECT	New Fan Tray for Vortex Rectifier (Lorain/Marconi 104545) (V200D50)	TFT-MRECT
TF-MREC-01	Vortex Rectifier (Lorain / Marconi) (V200D50) , 24V Fan w/ 3 Wire Open End	TF-MREC-01
TF-MREC-02	Vortex Rectifier (Lorain/Marconi) , 24V Fan & 3 Wire Plug (use in V200E50)	TF-MREC-02
TF-RHM400-01	RHM-400/800 Rectifier Unit (Lorain/Marconi) , 220VAC Fan	TF-RHM400-01
TF-LRA50B50-01	Lorain Rectifier (A50B50) , 48V Fan w/ 2 Wire Plug	TF-LRA50B50-01
TF-LRV50B50-01	Lorain Rectifier (V50B50) , 24V Fan w/ 3 Wire Plug	TF-LRV50B50-01
LUCENT FANS (CBX500, DDM-2000, METROPOLIS, FT-2000, DACS III / IV)		
TF-DDM201	Lucent DDM-2000 , 24V Fan	TF-DDM201
TF-DDM201-KIT1	Lucent DDM-2000 , 24V Fan Kit w/ Mounting Plate	TF-DDM201-KIT1
TF-DDM202	Lucent DDM-2000 , 48V Fan (for Nidec T35078-LUC 440233, Com 408741205) (fan only)	
TF-CBX500-01	Lucent CBX500 OCD , 12V Cooling Fan w/ 3 Wire Pins	TF-CBX500-01
TF-DMXMET-01	Lucent Metropolis DMX , 48V Fan w/ 4 Wire Plug	TF-DMXMET-01
TF-DMXMET-02	Lucent Metropolis DMX Access Multiplexer , 48V Fan w/ 4 Wire Black Plug	TF-DMXMET-02
TF-FT201	Lucent FT-2000 , 48V Fan w/ 3 Wire Plug	TF-FT201
TF-DACS3/4-01	Lucent DACS III / IV , 48V Fan w/ 4 Wire Plug (KS23913L1 Equiv.)	TF-DACS3/4-01
TF-DACS3/4-02	Lucent DACS III / IV , 48V Fan w/ 5 Wire Plug (KS23913L1 Equiv.)	TF-DACS3/4-02

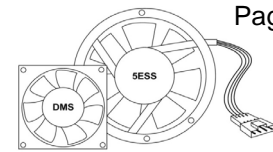

Part #	Description	FTR UPN #
NEC FANS		
TF-NEC-01	NEC , 48V Fan (fan only) (FD-31201A / FD-32401A)	TF-NEC-01
TF-NEC01-KIT1	NEC , 48V Fan Kit w/ Mounting & Grill (FD-31201A / FD-32401A)	
TF-NEC-02	NEC , 48V Fan (fan only) (ITS-2400)	
TF-NEC02-KIT1	NEC , 48V Fan Kit w/ Mounting & Grill (ITS-2400)	
TF-NEC-03	NEC , 48V Fan (fan only) (ITS-2400V FL)	
NORTEL FANS (DMS, Carrier VoIP, DPCC SuperNode "Squirrel Cage" Blowers)		
TF-DMS01	DMS-100 , 48V Fan w/ Power Prongs (use in NT3X90AC / NTB63AA fan trays)	TF-DMS01
TF-DMS02	DMS-1U , 48V Fan w/ Pwr Prongs (unthreaded mtg) (use in NT3X90AC / NTB63AA fan trays)	TF-DMS02
TLMP-DMFA-10	DMS Fan Alarm Repl. Lamp ("Fan Fail" / "Frame Fail") (QTY of 10)	
TLMP-DMFA-25	DMS Fan Alarm Repl. Lamp ("Fan Fail" / "Frame Fail") (QTY of 25)	
TLMP-DMSA-10	DMS Aisle Alarm Repl. Lamp (QTY of 10)	
TFT-DMS48KIT4	DMS-100 (NT3X90AA / NT3X90AB), 24VAC to 48VDC Fan Tray Conversion Kit 4	TFT-DMS48KIT4
TFT-3X9013T ***NEW***	TAG Universal DMS-100 3X9013 Fan Tray (NEW TRAY is pre-assembled w/ (5) NEW fans, Alarm Board, Wiring Harness w/ Connector & Universal Mounting Holes for NT3X90AA / AB / AC / AF) - No 24VAC Inverters - No Paddle Sensors	TFT-3X9013T
TF-DMS03	DMS-100 , 48V Fan w/ TTL Tach & 3 Wire Plug (use in NT3X90AF fan trays)	TFDMS03
TFC-3X90AF-01	DMS-100, Fan Alarm Board for the NT3X90AF Cooling Fan Unit	
TF-DMS04C	DMS-100 , 24VAC Fan w/ Power Prongs (use in NT3X90AA / NT3X90AB fan trays)	TFDMS04C
TF-RX50FF-01	DMS SDM , 12V Fan w/ 3 Wire Plug & Speed Control (use in Nortel SDM # NTRX50FF)	TF-RX50FF-01
TF-DMS-NTRX91	DMS-100 , 48V Fan (use in NTRX91AA / NT0X91AA, CLEI: ENMYACM)	TF-DMS-NTRX91
TF-DMS10-01	DMS-10 , 48V Fan w/ Power Prongs	TF-DMS10-01
TF-DMS-FOS	Nortel IW SPM-IP , 48V Fan for NTLX56AA Fan Assemblies (fan only)	TF-DMS-FOS
TF-MG9K-01	Nortel/GENBAND Media Gateway 9000 , 48V Fan w/ 3 Wire Plug (for NTNY18AA)	TF-MG9K-01
TF-DMSLGN6-01	DMS-500/250 DPCC (225mm) Impeller Fan for XA-Core Blower Drawer	
TF-DMSMCL-02	DMS-100 Dual-Scroll Blower Replacement Unit	TF-DMSMCL-02
TFC-DMSAPW-3	Alarm Board Replacement for DMS LIM / ENET Blower	
TF-DMSLGN5	DMS-100 DPCC SuperNode Blower "Squirrel Cage" Replacement	TF-DMSLGN5
SIEMENS EWSD FANS		
TF-EWSD-01	Siemens EWSD , Square 48V Fan w/ Power Prongs (fan only, use with existing guard grill)	TF-EWSD-01
TF-EWSD-02	Siemens EWSD , Round 48V Fan w/ Power Prongs (fan only, use with existing guard grill)	
STROMBERG CARLSON DCO FANS		
TF-DCOCMF-01	48V Fan for Stromberg Carlson DCO CMF Bay w/ 3 Leads & Fastons	TF-DCOCMF-01
TF-DCODCF-01	48V Fan for Stromberg Carlson DCO DCF Bay w/ 3 Leads & Spade Lugs	
TF-DCONHD-01	48V Fan for Stromberg Carlson DCO Non-HD CMF Bay w/ 2 Wire Open End	TF-DCONHD-01
TF-DCOMEF-01	48V Fan for Stromberg Carlson DCO MEF Bay (80mm x 45mm) w/ 3 Wire Plug	TF-DCOMEF-01
TF-DCO-02	48V Fan for Stromberg Carlson DCO CMF / DTF Bay w/ 3 Leads & Fastons	TF-DCO-02
STP RING NODE / WAVESTAR / WIDEBAND 3190 FANS		
TF-STPRN-01	STP Ring Node Frame/Cabinet , 48V Fan w/ 5 Wire Plug	
TF-WSTR-01	WaveStar TDM 10G , 48V Fan w/ 3 Wire Plug	
TF-WB3190	Wideband 3190 , 48V Fan w/ 3 Wire Plug	
TELCO SYSTEMS FANS		
TF-EL100	Edgelink 100 , Fan (40mm)	TF-EL100
TF-EL100DET	Edgelink 100 , Detector PC Board	
TF-EL100-KIT2	Edgelink 100 , Fan Kit (40mm)	TF-EL100-KIT2
TF-EL100-02	Edgelink 100 , Fan (35mm)	TF-EL100-02
TF-EL330-01	Edgelink AX330G1 , Fan (80mm) w/ 3 Wire Plug	
OSP CABINET / TRAY FANS & ALARM CONTROL UNITS		
TF-NTOPAC	48V Fan for Nortel Opac / OPM Cabinet w/ Round Weatherproof Connector	TF-NTOPAC
TF-NTOPAC-02	48V Fan for Nortel Opac / OPM Cabinet w/ Sealed 3 Pin Plug	TF-NTOPAC-02
TF-NTOPAC-04	48V Fan for Nortel Opac / OPM Cabinet w/ Sealed 3 Pin Plug	TF-NTOPAC-04
TF-NTOPAC-3	48V Fan for Nortel OPAC / OPM Cbnt (Access Node), 800A HX w/ 3 Wire Open End	TF-NTOPAC-3
TFG-162KIT-01	Guard Grill Repl. Kit for Round 162mm Fans (includes hardware)	TFG-162KIT-01
TF-NTOPAC-05	48V Fan for Nortel Opac Access Node Tray / 800A Cabinet w/ 3 Wire Plug (w/FPS)	TF-NTOPAC-05
TF-NTOPAC-05F	48V Fan for Nortel Opac Access Node Tray w/ Power Prongs, Untermin. FPS Lead	
TF-NTANCFT-01	48V Fan for Nortel Access Node/Charles Tray (92-FAN840-X) w/ 3 Wire Plug	TF-NTANCFT-01
TF-DMS06	48V Fan for BFU in DMS-100 OPM Cbnt w/ Pwr Prongs & Unterminated Tach Lead	TF-DMS06
TFR-8X06ABT	Tray Refurbish-Paddleless Alarm Conversion Upgrade for DMS OPM NT8X06AB	TFR-8X06ABT
TF-ES660-01	24V (60x25mm) Fan for Lucent ES660 Rectifier Unit w/ 2 Wire Plug	TF-ES660-01
TF-SLCAPW-01	(1) 48V Fan for SLC 2000 Cabinet - Reltec / Mclean APW Tray	TF-SLCAPW-01
TF-SLCAPW-04	(4) 48V Fans for SLC 2000 Cabinet - Reltec / Mclean APW Tray	TF-SLCAPW-04
TFC-SLCAPW-4	Alarm Control Board for Reltec / Mclean APW Fan Tray	TFC-SLCAPW-4

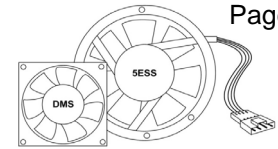

Part #	Description	FTR UPN #
OSP CABINET / TRAY FANS & ALARM CONTROL BOARDS - continued from previous page		
TF-SLC201-02	48V Heat Exch. for 80 Type Cabinet w/ Round Screw on Conn (KS23912L4 Equiv.)	TF-SLC201-02
TFC-114A-01	114A Fan Control Unit for 80 Type Cabinet Heat Exchangers (equiv. to 106894934)	
TFC-LU4-01	Alarm Control Board for Lucent 4A/4B, 4G/SLC2000 Tray & 114A Control Unit	TFC-LU4-01
TF-SLCBC-01	48V Battery Cooling Fan for 80 Type Cabinet w/ 3 Wire Plug	TF-SLCBC-01
TFC-116A-01	Alarm Control Board for Lucent 116A Battery Fan Unit (use with existing bracket)	
TF-SLC201	48V Fan for SLC 2000 - Lucent 4A/4B Tray w/ 5 Wire Plug (KS23912L6)	TF-SLC201
TFCS-LU4APA-06	Power Cable for Lucent 4A/4B Fan Tray , (6')	TFCS-LU4APA-06
TF-LU2A	48V Fan for Lucent 2A Tray w/ 3 Leads & Fastons (KS22501L5)	TF-LU2A
TF-LU2B	48V Fan for Lucent 2B Fan Tray w/ 3 Wire Plug (KS22501L5A)	TF-LU2B
TF-SLC5-01	48V Fan for SLC5 Cabinet Lucent 2B Fan Tray w/ 3 Wire Plug (KS22501L5A)	TF-SLC5-01
TFC-LU2BC-01	Alarm Control Board for Lucent 2B & 2C Fan Trays	TFC-LU2BC-01
TF-LU2C	48V Fan for Lucent 2C Fan Tray w/ 3 Wire Plug (KS22501L5A)	
TF-LU2C-02F	48V Fan for Lucent 2C Fan Tray w/ 3 Wires & Faston Connectors	
TF-ALC7330-4	Alcatel 7330 VRAD Fan Kit w/ Quick Install Template Plate	TF-ALC7330-4
TF-ALC7330-C	(1) Individual Alcatel 7330 VRAD 48V Fan w/ 3 Wire Open End for splicing	TF-ALC7330-C
TF-ALC7342-01	48V Fan for Nokia 7342 Rolt Fan Tray w/ 4 Wire Plug	
TF-ALC1218-01	24V Fan for Alcatel 1218 Cabinet Tray w/ 2 Wire, 3 Pin Connector	TF-ALC1218-01
TF-ALC1218-02	48V Fan for Alcatel 1218 Cabinet Roof w/ 2 Unterminated Leads	TF-ALC1218-02
TFC-248E-01	Battery Vent Fan Control Board for (Emerson) ALP-248E/448E Cabinets	
TF-PURALP-01	48V HX for ALP-248/448 (Purcell) Cabinet Door (Bottom) & Battery Cooling w/ 4 Wire Plug	TF-PURALP-01
TF-PURALP-02	48V HX for ALP-248/448 (Purcell) Cabinet Door (Top) w/ 4 Wire Plug & Grommet	
TF-COM6DF-01	48V Fan for CommScope Cbnt, 6D/F Bay, VAUCADY(XXX) w/ internal sensor & 3 Wire, 6 Pin Plug	TF-COM6DF-01
TF-COM6DF-02	48V Fan for CommScope Cabinet, ALP HX Door w/ 5 Wire, 6 Pin Connector	TF-COM6DF-02
TF-COM6DF-02R	48V Fan for CommScope 82 Cbnt, HX Door w/ 5 Wire, 6 Pin (includes 10K thermistor cable)	
TF-COM6DF-04	48V Fan for CommScope Cbnt, 6D/F Bay, VAUCADY(XXX) w/ internal sensor & 3 Wire, 4 Pin Plug	
TF-COM6BC-01	48V Fan for CommScope Cbnt, 6B/C Battery / ALP HX Door w/ 3 Wire, 4 Pin Connector	TF-COM6BC-01
TF-COM52E-01	48V Fan for CommScope 52E Cbnt, Battery w/ (1) 2 Wire, 4 Pin Conn & (1) 2 Wire, 2 Pin Plug	
TFT-COM48B-01	3 Fan Stainless Steel Assembly for CommScope ALP 448/248 HX Door Fans	
TFT-SLC96-AC01	110VAC Fan w/ Bkt Assembly for SLC96 (36 Type) Cabinet (KS22099L5 Equiv.)	TFT-SLC96-AC01
TFT-SLC96-AC01L	110VAC (Low Temp) Fan w/ Bkt Assembly for SLC96 (36 Type) Cabinet (KS22099L5)	TFT-SLC96-AC01L
TF-SLC96-AC02	110VAC Fan (fan only) for SLC96 (36 Type) Cabinet (use w/ KS22099L5)	TF-SLC96-AC02
T-THST9568	Thermostat Temperature Control Switch, 95/68 (OFF=68F, ON=95F)	T-THST9568
T-THST10585	Thermostat Temperature Control Switch, 105/85	T-THST10585
TF-FUJ6200-01	48V Heat Exchanger for Fujitsu 6200 Cabinet w/ 5 Wire Plug	
TF-FUJ6200-02	48V Fan for Fujitsu 6200 Cabinet Tray w/ Power Prongs	
TF-FUJ6200-03	48V Fan for Fujitsu 6200 Cabinet Tray w/ 3 Wire Open End & Power Prongs	
TF-NP0402-01	48V Heat Exch. for Noren Cooling Unit - Internal (6.71K) w/ 3 Wire Open End	TF-NP0402-01
TF-NP0414-02	48V Heat Exch. for Noren Cooling Unit - External (8.45K) w/ 3 Wire Open End	TF-NP0414-02
TF-SPB-AC01	120VAC Fan for Seiscor / Pulsecom "B" Cabinet w/ Power Prongs	TF-SPB-AC01
TF-SPD-AC01	110VAC Fan for Seiscor / Pulsecom "D" Cabinet w/ Power Prongs & Guard Grill	TF-SPD-AC01
TF-DCORLS-01	48V Fan for Stromberg Carlson DCO RLS Cabinet Tray w/ 3 Fastons & Power Prongs	TF-DCORLS-01
TF-UMC1000-01	48V Fan (120mm) for Tellabs UMC1000 Tray w/ 3 Wire Plug (use in AFC Tray w/ 6 fans)	TF-UMC1000-01
TFC-UMC1000-06	Alarm Control Board for Tellabs UMC1000 6 Fan Tray	TFC-UMC1000-06
TF-UMC1000-02	48V Fan (80mm) for Tellabs UMC1000 Tray w/ 3 Wire Plug (use in AFC Tray w/ 10 fans)	TF-UMC1000-02
TF-UMC1000-03	48V Fan (120mm) for Tellabs UMC1000 Tray w/ 4 Wire Plug (use in AFC Tray w/ 8 fans)	TF-UMC1000-03
TF-UMC672-01	48V Fan for UMC672 Cabinet w/ 2 Wire Plug (fan only, use with existing metal housing)	
TF-LS2000-01	48V Fan for Litespan 2000 PDFA w/ 3 Wire Plug & Grill (use in # 500-1126-723)	TF-LS2000-01
TFC-PDFA-X2	Alarm Control Board for Litespan 2000 PDFA Fan Trays	
TF-LS2000-02	48V Fan for Litespan 2000 High Velocity PDFA w/ 3 Wire Connector	TF-LS2000-02
TFC-PDFA-01	Alarm Control Board for Litespan 2000 High Velocity PDFA Fan Trays	
TF-LS2000-03	48V Heat Exchanger for Litespan 2000 Cabinet w/ Unterminated Leads	TF-LS2000-03
TF-LS2KSB-01	48V Heat Exchanger for Litespan 2000 Cabinet Heat Stack w/ Power Prongs	
TF-LS2000-44	Litespan 2000 DFA Fan Kit ((4) 48V Fans & (1) Wiring w/ Plug (use in tray # 500-1100-XXX)	TF-LS2000-44
TF-LS2000-04	(1) Individual 48V Fan for Litespan 2000 DFA Tray w/ 3 Wire Open End (for splicing)	TF-LS2000-04
TFC-DFA-01	Alarm Control Board for Litespan 2000 DFA Fan Trays	
TF-LRA25B50-01	Lorain Rectifier (A25B50) , 24V Fan w/ 3 Wire Plug	
TF-LPM-01	48V Fan for Lorain Power Module w/ Power Prongs (fan only)	
TF-LPCM-01	24V Fan (80mm) for Lorain Power Conversion Module (V15F50/P) w/ 3 Wire (M) Plug (fan only)	
TF-MESACL-01	48V Fan for Marconi Current Limiter w/ 3 Wire Plug	

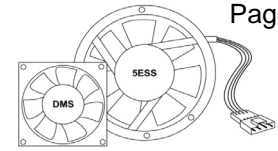

Part #	Description	FTR UPN #
OSP CABINET / TRAY FANS & ALARM CONTROL BOARDS - continued from previous page		
TF-ACABTZ-01A	48V HX (Tarzan) for Litespan 2000 (LSC-2030) Cabinet w/ Adapter Cable	TF-ACABTZ-01A
TF-ACABLHX-01	48V HX for Litespan 2000 (LSC-2030) Cabinet (Lower) w/ 3 Leads & 2 Connectors	
TF-MCABTZ-01	48V Heat Exchanger (Tarzan) for Marconi Mesa "Top" HX Cabinet w/ 3 Wire Plug	TF-MCABTZ-01
TF-MARCTOP-01	48V Fan for Marconi Cabinet (Top/Inside) w/ Power Prongs	TF-MARCTOP-01
TF-MESA6-01	48V HX for Marconi Mesa "Bottom" HX Cbnt w/ 3 Wire Plug	TF-MESA6-01
TFC-FA400-01	Alarm Control Board Replacement for Marconi Mesa Master Tray	TFC-FA400-01
TF-FA400-01	48V Fan for Marconi Mesa Cabinet Master Fan Tray w/ 3 Wire Plug	TF-FA400-01
TF-FA400-02	48V Fan for Marconi Mesa Cabinet Slave Fan Tray w/ 3 Wire Plug	TF-FA400-02
TFC-MARC6-01	6 Position Environmental Control Unit (ECU) for Marconi Cabinet (supports 6 HX fans)	TFC-MARC6-01
TFC-WORX-FAM1	PowerWorx Front Access Fuse Panel (Equiv. to ADC # TFA-FAM)	
TF-MESA384-01	48V (External) HX for Mesa DSLAM 384 Cbnt w/ 4 Wire (Round) (F) Wthprf Plug	
TF-MESA384-02	48V (Internal) HX for Mesa DSLAM 384 Cbnt w/ 4 Wire (Square) Female Plug	
TFC-MESA-04	4 Port Environmental Control Unit (ECU) (used in Mesa 2 - DSLAM 192 & 384)	
TFC-MESA-02	2 Port Environmental Control Unit (ECU) (used in Mesa 2 - DSLAM 192 Type Cabinets)	
TFC-MESA246-01	6 Fan Environmental Control Unit (ECU) for Remote Cabinet Sites	TFC-MESA246-01
TF-MC133-02	(133mm) HX for Mesa 768 Cabinet w/ 3 Pin Plug (fan only)	TF-MC133-02
TF-MC133-05	(133mm) HX for Mesa Sport Cabinet w/ 3 Pin Bulkhead Plug	TF-MC133-05
TF-CSHX133-01	(133mm) HX for Cell Site Mesa Sport Cabinet w/ 4 Pin (M) Wthprf Plug (fan only)	TF-CSHX133-01
TF-MC133-01	(133mm) Heat Exchanger for Purcell FlexAir 741 Cabinet (Door) w/ 4 Leads & Fastons	
TF-MC175-04	(175mm) Heat Exchanger for Purcell A009 Cabinet w/ Wthprf Connector (fan only)	
TF-MC175-04-KIT	(175mm) Heat Exchanger KIT for Purcell A009 Cbnt w/ Wthprf Connector & Bracket	TF-MC175-04-KIT
TF-SRA200-01	(175mm) HX for SRA-200 Cabinet w/ 3 Wire Plug (fan only, use with existing bracket)	
TF-MC175-02	(175mm) Heat Exchanger for Mesa 4 NXT Cabinet (use in Siemens ICN 087-23500-10)	
TF-MC175-03	(175mm) Heat Exchanger for OSP Cabinet w/ 3 Pin Plug (fan only)	TF-MC175-03
TF-MC175-01	(175mm) HX for Siemens 914EX Metro MXU Cabinet w/ 2 Wire Open End	TF-MC175-01
TF-914EHX-01	48V HX for Siemens 914E RT Cabinet w/ Power Prongs	
TF-914EXMET-01	48V Fan for Siemens 914EX Metro MXU Fan Tray w/ Power Prongs	TF-914EXMET-01
TF-HX175LP-01	(175mm) "Low Profile" HX for Calix ODC Door w/ Grommet, 4 Leads & Fastons	TF-HX175LP-01
TF-HX220LP-01	(220mm) "Low Profile" HX for Calix ODC 1000 Cabinet w/ 4 Leads & Fastons	TF-HX220LP-01
TF-OPM640HX	(175mm) "Low Profile" HX for OPM 640 Cbnt (Retro Fit Roof) w/ 3 Wire, 4 Pin Plug	
TF-AFCHX-01	(175mm) "Low Profile" HX for AFC Fan Unit found in OPM Cbnts w/ 2 Wire, 4 Pin	TF-AFCHX-01
TF-CATNHX-01	(175mm) "Low Profile" HX for Catena Cabinet w/ (1) 2W Plug & (1) 3W, 4 Pin Plug	
TF-RECARGUS-01	12V (80mm) Fan for Argus Rectifier w/ 2 Wire Plug	
TF-RECARGUS-02	24V (80mm) Fan for Argus Rectifier w/ 2 Wire Right Angle Plug	
TF-RECARGUS-03	24V (80mm) Fan for Argus Rectifier w/ 2 Wire Right Angle Plug & Threaded Inserts	
TF-RECARGUS-04	12V (120mm) Fan for Argus Rectifier Cabinet w/ 2 Wire Open End	TF-RECARGUS-04
TF-AI-SCT-01	48V (80mm) Fan for AISCOUT w/ 3 Wire Right Angle Plug	
TF-CN5150HX-01	48V HX for Telamon/Ciena 5150 EMUX Cbnt Door w/ 4 Wires & Seated Connector	
TF-DISCSCPU-01	48V Fan for DISC*S CPU w/ 2 Wire Open End (fan only)	
TF-OPTI-01	12V Fan for Adtran Opti 6100 Fan Trays w/ 3 Wire Plug (use in 1184508L2)	
TF-TA3000-01	48V Fan for Adtran TA3000 w/ 3 Wire Plug (for HECI M3PQ0AV, 1181006L1)	
TF-TA5K-01	48V Fan for Adtran TA5000 w/ 4 Wire Plug	TF-TA5K-01
TF-TA5K-02	48V Fan for Adtran TA5000 w/ 3 Wire Plug	TF-TA5K-02
TF-MC179-01A	Heat Exchanger for Mesa Bridge Cabinet (Upper - Internal) w/ 4W (F) Wthprf Plug	
TF-MC179-01	Heat Exchanger for Mesa Bridge Cabinet (Lower - Door) w/ 4W (F) Wthprf Plug	TF-MC179-01
TF-CQ250-01	(250mm) HX for Ice Qube Cabinet w/ 4 Wire Open End	
TF-AFC672-01	48V Fan for AFC Cabinet Heat Stack w/ Power Prongs	TF-AFC672-01
TF-CLXODC-01F	48V Heat Exch. for Calix ODC Stack w/ 2 Wires & Fastons	
TFC-CALIX2KHX	Alarm Control Board for Calix ODC-2000 Cabinet HX Controller (alarm board only)	
TF-CLX225-01	(225mm) HX Impeller Fan (Upper) for Calix ODC Cbnt w/ 4 Wire Female Plug, (14" cable)	
TF-CLX225-02	(225mm) HX Impeller Fan (Upper) for Calix ODC Cbnt w/ 4 Wire Female Plug, (30" cable)	
TF-CLX225-03	(225mm) HX Impeller Fan (Lower) for Calix ODC Cbnt w/ 4 Wire Male Plug, (30" cable)	
TF-CLX133-01	(133mm) HX Impeller Fan (Upper/Lower) for Calix Cabinet w/ 4 Wire Plug	
TF-MCCHX-AC01	110 VAC HX Blower for Reltec / McLean Cbnt w/ 3 Prong Pwr Plug & Adapter Plate	
TF-MCCHX-AC0R	110 VAC HX (Right) Blower for Reltec/McLean Cbnt w/ 3 Prong Pwr Plug & Adapter Plate	
TF-TX33HX-01	(175mm) HX for Mclean ClimaGuard Cabinet Cooler w/ 4 Wire Weatherproof Conn.	
TF-TX38HX-01	(225mm) HX for Mclean ClimaGuard Cabinet Cooler w/ 4 Wire Weatherproof Conn.	
TFC-MESA-01	2 Port Mesa Cabinet ECU (used in Cell Sites: XL, SOLE, Span XL, Bridge, Edge & Sport)	TFC-MESA-01
TF-MC225-01	(225mm) Heat Exch. for Mesa Cabinet (Top) w/ Weatherproof Connector (fan only)	TF-MC225-01
TF-MC225-02	(225mm) Heat Exch. for Mesa Cabinet (Bottom) w/ 4 Wire Plug (fan only)	TF-MC225-02

Don't see the fan you are looking for? Send us a sample & we will find a match!

PLEASE CALL: 856-753-8585 or EMAIL: custsvcs@tagcords.com

5ESS "Pre-Charge" Tool

T-5ESSPCT

5ESS Fuse Bay Control Panel,
Lucent # ED-83024-30

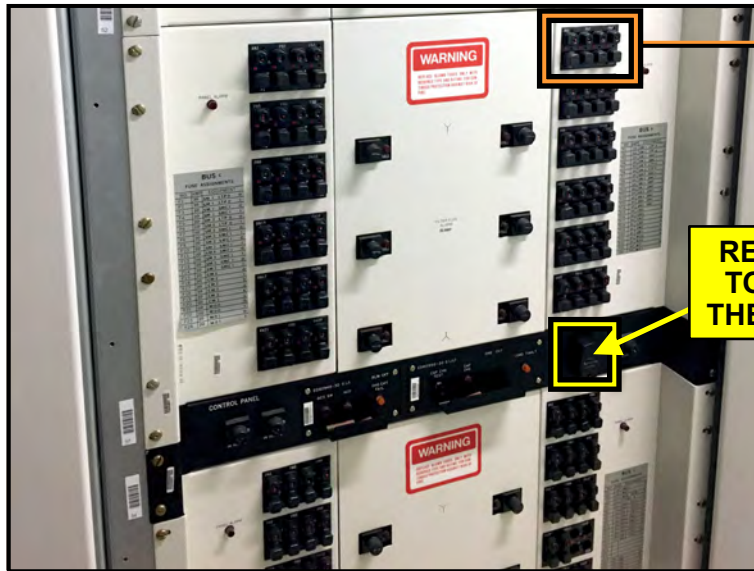

**REPLACES BROKEN
TOOL LOCATED ON
THE CONTROL PANEL**

FTR UPN # T-5ESSPCT
5ESS Pre-Charge Tool
*(control panel pre-charge
tool replacement)*

PUSH TO CHARGE



1. INSERT PROBE (ALARM FUSE)
2. PRESS TEST BUTTON
3. RED & GRN LEDS WILL LIGHT
4. 4-6 SEC LEDS WILL GO OUT
5. INSTALL MAIN FUSE
6. IF RED LED STAYS ON EXCESS LOAD OR SHORT IS PRESENT

Application:

TAG's PN # T-5ESSPCT is used to pre-charge shelf power capacitors of a 5ESS switch. This allows a new fuse to be installed without seeing full in-rush surge current. The indicator light goes out when it is safe to install the fuse.

Ordering Information:

5ESS "Pre-Charge" Tool for Capacitor Charging at Main Fuse Bay
(control panel pre-charge tool replacement)

**FTR UPN #
T-5ESSPCT**

150 Cooper Rd. (F-15)
W. Berlin, NJ 08091

www.tagcords.com
Telecom Assistance Group

Telephone: (856) 753-8585
Fax : (856) 768-7645

TAG DMS-100 3X9013 Universal Fan Tray

TFT-3X9013T

Universal 48VDC Fan Tray

- No 24VAC Inverters

(24VAC inverters cause heat concerns & major equipment failures)

- No Mechanical Sensors

(sensor paddles are known to bend & break)

INSTALLATION VIDEOS:



NT3X90AA/AB



NT3X90AC



NT3X90AF

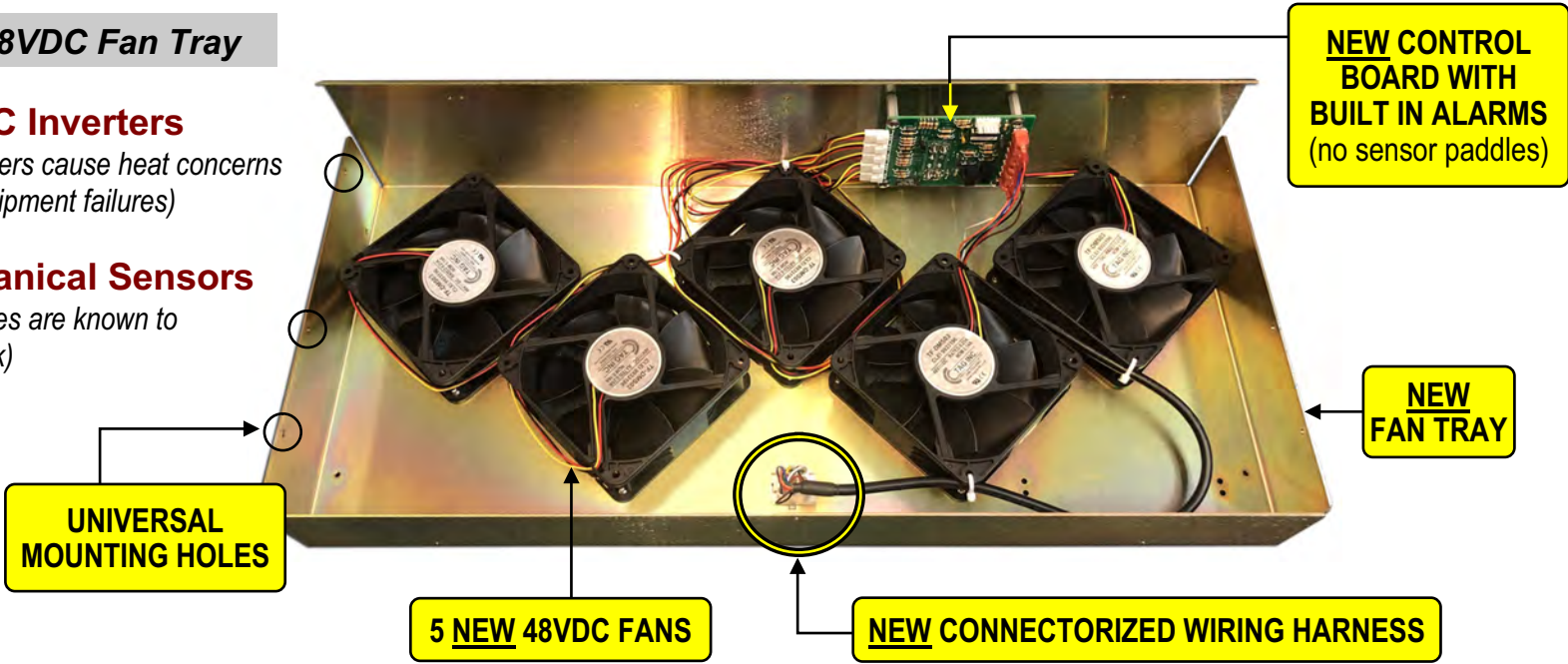

- Connectorized Universal metal tray with Fan Alarm Board (no sensor paddles)
- Pre-assembled & works with NT3X90AA, NT3X90AB, NT3X90AC & NT3X90AF Cooling Units
- Adapter cables* are supplied for NT3X90AA/AB & NT3X90AF Cooling Units
*(adapter cables are not used with NT3X90AC)

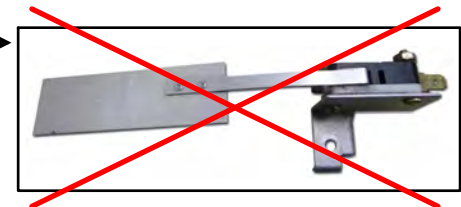

Ordering Information:

TAG Universal DMS-100 3X9013 Fan Tray

Includes: (1) Brand New Fan Tray w/ Universal Mounting Holes,
 (5) TF-DMS03, 48VDC Fans w/ TTL Tach & 3 Wire Plug,
 (1) Fan Control Board w/ Built in Sensors (no paddles needed), Wiring Labels, Mounting Hardware,
 (1) Wiring Harness w/ Connector, NT3X90AA/AB & NT3X90AF Adapter Cables & Installation Guide

FTR UPN #
TFT-3X9013T

150 Cooper Rd. (F-15)
 W. Berlin, NJ 08091

www.tagcords.com
Telecom Assistance Group

Telephone: (856) 753-8585
 Fax: (856) 768-7645