

Verizon

2025 Product Ordering Guide

[Issue 1.0](#)



Provided By:



The "Cord Company" and more . . .

"TEST CORDS & ADAPTERS"

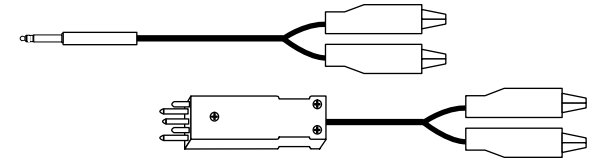

"TEST BOARDS & STREAKER CARDS"

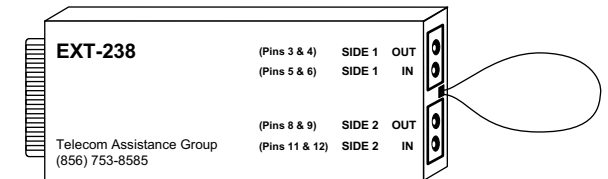

"SWITCH TERMINALS"

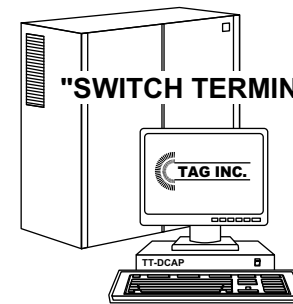

"FANS"

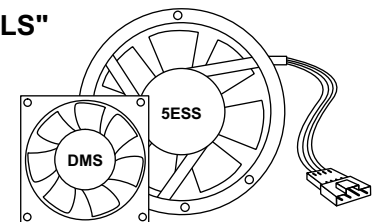







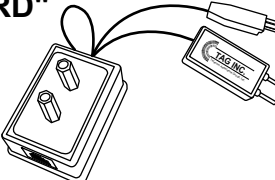
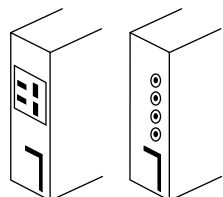
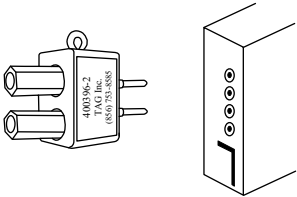

"NEBS CERTIFIED SOLID STATE SCSI DRIVES"

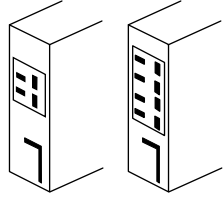

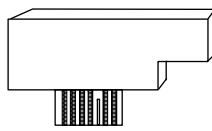







www.tagcords.com







- 856-753-8585

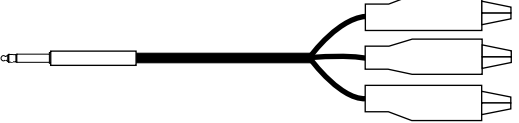



FEATURES / APPLICATION	PART #	DESCRIPTION
<p>"The SLICK CORD", (2')</p> <ul style="list-style-type: none"> Dual Purpose cord for Series 5 / SLC 2000 and / or SLC-96 / DISC*S faceplate access 	<p>4003956</p> <p>VZ ID # 1100 7835</p>	<p>"SLICK CORD"</p>   <p>Series 5 SLC-96</p>
<p>SLC-96 Line Adapter</p> <ul style="list-style-type: none"> Hollow post access to Odd / Even Channels at faceplate of SLC-96 / DISC*S channel units 	<p>400396-2</p> <p>VZ ID # 1100 7836</p>	<p>SLC-96 LINE ADAPTER</p>  <p>SLC-96</p>
<p>SLC Series 5 Test Cord, (1')</p> <ul style="list-style-type: none"> Dial tone access at faceplate of Series 5 or SLC 2000 	<p>400395-2</p> <p>VZ ID # 1100 7834</p>	<p>SLC SERIES 5 TEST CORD</p>   <p>Series 5 SLC 2000</p>
<p>SLC-96 Line Adapter to Alligator Clips, (1')</p> <ul style="list-style-type: none"> Use at faceplate or SLC-96 or DISC*S channel units to get dial tone access Easy alligator connection to butt-sets 	<p>400396-2A</p> <p>VZ ID # 1100 7837</p>	<p>SLC-96 LINE ADAPTER to ALLIGATORS</p>  <p>SLC-96</p>
<p>SLC-96 Looping Plug</p> <ul style="list-style-type: none"> Loops SLC-96 circuits at the LIU 	<p>400396L</p> <p>VZ ID # 8702 8112</p>	<p>SLC-96 LOOPING PLUG</p> 





FEATURES / APPLICATION	PART #	VZ ID #	DESCRIPTION
Bantam to Bantam - Red, (6') Bantam to Bantam - Red, (3') Bantam to Bantam - Red, (8') Bantam to Bantam - Red, (13')	400210RD 400210RD-03 400210RD-08 400210RD-13	1104 3640 1100 7946 1100 7947 1125 8962	BANTAM to BANTAM - RED 
<ul style="list-style-type: none"> • General purpose test / patch cord 			
Bantam to Bantam - Black, (6') Bantam to Bantam - Black, (3') Bantam to Bantam - Black, (8') Bantam to Bantam - Black, (13')	400210BK 400210BK-03 400210BK-08 400210BK-13	1104 3639 1100 7943 1100 7944 1125 8963	BANTAM to BANTAM - BLACK 
<ul style="list-style-type: none"> • General purpose test / patch cord 			
Bantam to Bantam, (6') Bantam to Bantam, (2') Bantam to Bantam, (4') Bantam to Bantam, (10') Bantam to Bantam, (12') Bantam to Bantam, (15') Bantam to Bantam, (20') Bantam to Bantam, (25') Bantam to Bantam, (30') Bantam to Bantam, (40') Bantam to Bantam, (50')	400210 400210-02 400210-04 400210-10 400210-12 400210-15 400210-20 400210-25 400210-30 400210-40 400210-50	8721 4240 8727 2187 8727 3292 8725 7313 8724 0825 8727 3294 8723 6197 8727 4263 8722 2495 8726 0958 1105 1326	BANTAM to BANTAM 
<ul style="list-style-type: none"> • General purpose test / patch cord 			
Right Angle Bantam to Right Angle Bantam, (2') Right Angle 310 to Right Angle 310, (2')	400210R 400310R	363418 8703 1754	RIGHT ANGLE PATCH CORD 
<ul style="list-style-type: none"> • "Right Angle" test cord for "Patching" T1 circuits inside SLC Series 5 or SLC-96 cabinets 			

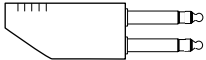

FEATURES / APPLICATION	PART #	DESCRIPTION
<p>Bantam to Protector - Red, (8') Bantam to Protector - Black, (8')</p> <ul style="list-style-type: none"> Wired Tip & Ring to long Pins No ground pin allows to flip and test both ways 	<p>400210SRD-08 400210SBK-08</p> <p>VZ ID # 1100 7949 1100 7948</p> <p>Red Black</p>	<p>BANTAM to PROTECTOR</p> 
<p>Bantam to Protector (non-bridging), (8') Bantam to Protector (non-bridging), (2')</p> <ul style="list-style-type: none"> Wired Tip & Ring to long Pins No ground pin allows to flip and test both ways 	<p>400210S 400210S-02</p> <p>VZ ID # 8721 8308 1107 3240</p> <p>8' 2'</p>	<p>BANTAM to PROTECTOR</p> 
<p>Bantam to Protector (bridging), (8')</p> <ul style="list-style-type: none"> Wired Tip & Ring to long Pins No ground pin allows to flip and test both ways 	<p>400210SM</p> <p>VZ ID # 8722 4880</p>	<p>BANTAM to PROTECTOR</p> 
<p>Bantam to Wire Wrap Terminals, (6')</p> <ul style="list-style-type: none"> Slides on standard CO terminal block pins (.045) for test access 	<p>400210WP</p> <p>VZ ID # 8702 8103</p>	<p>BANTAM to WIRE WRAP TERMINALS</p> 
<p>Bantam to "66" Block Alligator Clips, (6')</p> <ul style="list-style-type: none"> Access to "66" block connectors 	<p>400210PD</p> <p>VZ ID # 8725 1329</p>	<p>BANTAM to "66" BLOCK CLIPS</p> 

FEATURES / APPLICATION	PART #	DESCRIPTION
<p>Bantam to (2) Alligator Clips, (6') Bantam to (2) Alligator Clips, (3') Bantam to (2) Alligator Clips, (8') Bantam to (2) Alligator Clips, (12')</p> <ul style="list-style-type: none"> Access to various connectors, bare cable 	<p>400210A 400210A-03 400210A-08 400210A-12</p> <p>VZ ID # 8721 5490 6' 700 229 800 3' 1100 7827 8' 8725 3891 12'</p>	<p>BANTAM to ALLIGATOR CLIPS</p> 
<p>Bantam to (2) Alligator Clips - Red, (3') Bantam to (2) Alligator Clips - Red, (8')</p> <ul style="list-style-type: none"> Access to various connectors, bare cable 	<p>400210ARD-03 400210ARD-08</p> <p>VZ ID # 1100 7941 3' 1100 7942 8'</p>	<p>BANTAM to ALLIGATOR CLIPS</p> 
<p>Bantam to (2) Alligator Clips - Black, (3') Bantam to (2) Alligator Clips - Black, (8')</p> <ul style="list-style-type: none"> Access to various connectors, bare cable 	<p>400210ABK-03 400210ABK-08</p> <p>VZ ID # 1100 7939 3' 1100 7940 8'</p>	<p>BANTAM to ALLIGATOR CLIPS</p> 
<p>Bantam to (3) Alligator Clips, (6')</p> <ul style="list-style-type: none"> Access to various connectors, bare cable 	<p>400210A3</p> <p>VZ ID # 1100 7828</p>	<p>BANTAM to (3) ALLIGATOR CLIPS</p> 

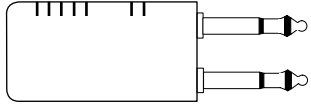
FEATURES / APPLICATION	PART #	VZ ID #	DESCRIPTION
<p>Bantam to 310, (6')</p> <p>Bantam to 310, (10')</p> <p>Bantam to 310, (12')</p> <p>Bantam to 310, (20')</p> <p>Bantam to 310, (25')</p> <p>Bantam to 310, (40')</p> <ul style="list-style-type: none"> General purpose test / patch cord 	<p>400310M</p> <p>400310M-10</p> <p>400310M-12</p> <p>400310M-20</p> <p>400310M-25</p> <p>400310M-40</p>	<p>8702 8145</p> <p>8726 1459</p> <p>8725 6116</p> <p>8724 7963</p> <p>1104 1392</p> <p>8726 0960</p>	<p>BANTAM to 310</p> 
<p>310 to 310 - RED, (13')</p> <ul style="list-style-type: none"> General purpose test / patch cord 	400310RD-13	1125 8964	<p>310 to 310 - RED</p> 
<p>310 to 310 - BLACK, (13')</p> <ul style="list-style-type: none"> General purpose test / patch cord 	400310BK-13	1125 8965	<p>310 to 310 - BLACK</p> 
<p>310 to 310, (6')</p> <p>310 to 310, (30')</p> <p>310 to 310, (40')</p> <ul style="list-style-type: none"> General purpose test / patch cord 	<p>400310</p> <p>400310-30</p> <p>400310-40</p>	<p>8702 8133</p> <p>8727 8046</p> <p>8726 0959</p>	<p>310 to 310</p> 
<p>310 to (2) Alligator Clips, (6')</p> <p>310 to (2) Alligator Clips, (8')</p> <p>310 to (2) Alligator Clips, (10')</p> <ul style="list-style-type: none"> Access to various connectors, bare cable 	<p>400310A</p> <p>400310A-08</p> <p>400310A-10</p>	<p>1100 7831</p> <p>1100 7832</p> <p>1100 7981</p>	<p>310 to ALLIGATOR CLIPS</p> 
<p>310 to Protector (non-bridging), (8')</p> <p>310 to Protector (non-bridging), (6')</p> <ul style="list-style-type: none"> Wired Tip & Ring to long Pins No ground pin allows to flip and test both ways 	<p>400310S</p> <p>400310S-06</p>	<p>8702 8124</p> <p>1107 3241</p>	<p>310 to PROTECTOR</p> 

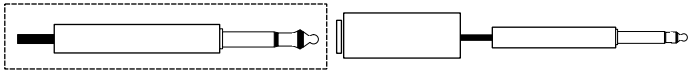
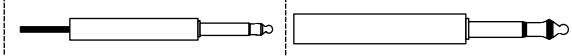

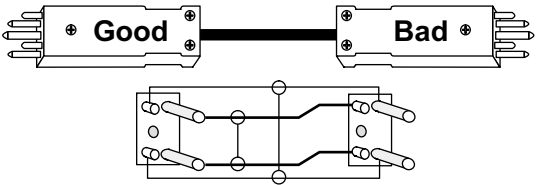
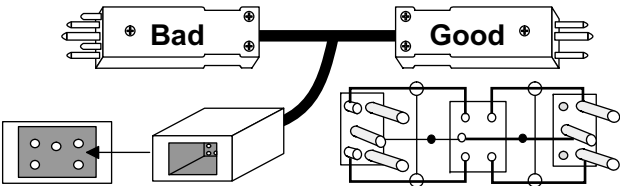
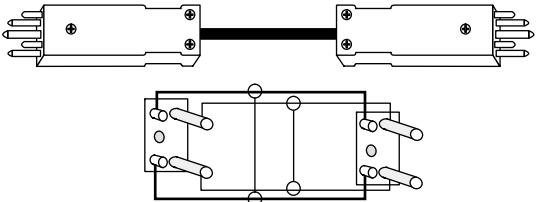
FEATURES / APPLICATION	PART #	VZ ID #	DESCRIPTION
<p>310 to Wire Wrap Terminals, (6')</p> <ul style="list-style-type: none"> Slides on standard terminal block pins (.045) for test access 	400310WP	1100 7833	<p>310 to WIRE WRAP TERMINALS</p> 
<p>310 to "66" Block Alligator Clips, (6')</p> <ul style="list-style-type: none"> Access to "66" block connectors 	400310PD	8722 0244	<p>310 to "66" BLOCK CLIPS</p> 
<p>Dual 310 to Dual 310, (6')</p> <ul style="list-style-type: none"> Patch cord Available in various lengths 	400310DD	8702 8107	<p>DUAL 310 to DUAL 310</p> 
<p>Dual Bantam to Dual Bantam, (6') Dual Bantam to Dual Bantam, (2') Dual Bantam to Dual Bantam, (10') Dual Bantam to Dual Bantam, (12') Dual Bantam to Dual Bantam, (15') Dual Bantam to Dual Bantam, (20') Dual Bantam to Dual Bantam, (25') Dual Bantam to Dual Bantam, (30') Dual Bantam to Dual Bantam, (40') Dual Bantam to Dual Bantam, (50') Dual Bantam to Dual Bantam, (75')</p> <ul style="list-style-type: none"> General purpose test / patch cord 	<p>400210DD 400210DD-02 400210DD-10 400210DD-12 400210DD-15 400210DD-20 400210DD-25 400210DD-30 400210DD-40 400210DD-50 400210DD-75</p>	<p>8702 8141 8725 6802 8725 6615 364581 1136 1856 8723 8449 8727 5015 8722 5337 8725 0208 8728 6622 8728 4587</p>	<p>DUAL BANTAM to DUAL BANTAM</p> 
<p>Female Bantam to Female Bantam, (12')</p> <ul style="list-style-type: none"> Use as an extension cord to connect (2) Bantam patch cables for longer distances 	400200F-12	8729 1186	<p>FEMALE BANTAM to FEMALE BANTAM</p> 



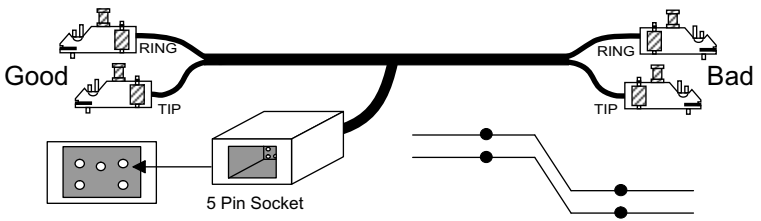
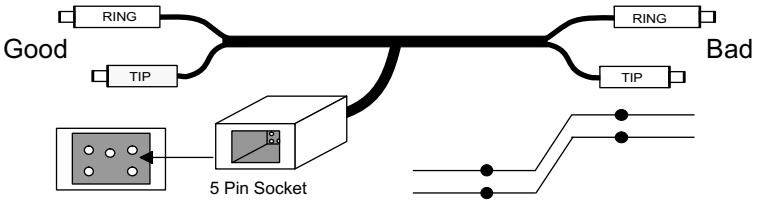
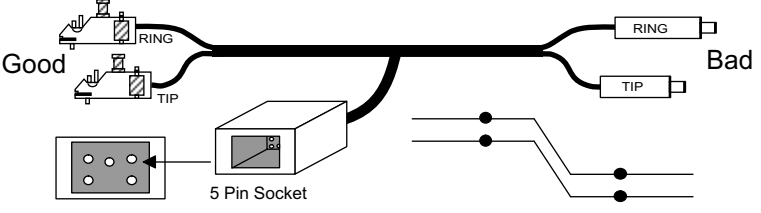
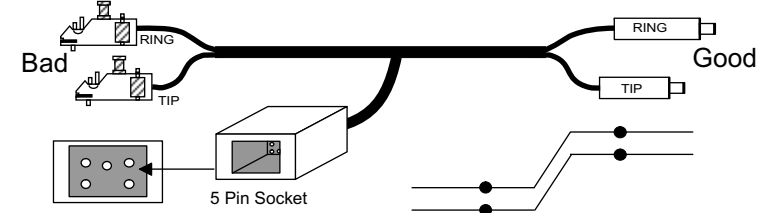

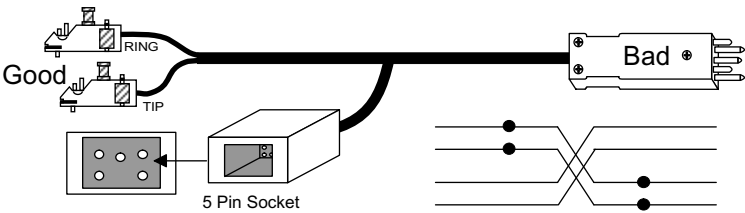
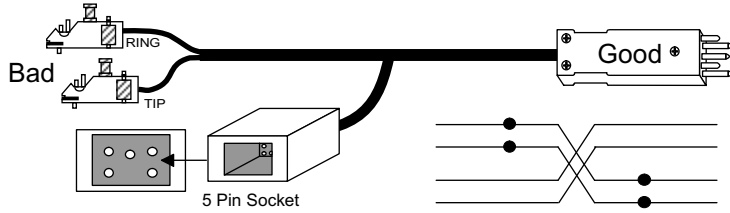
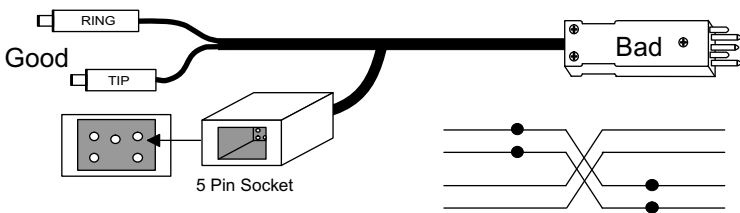
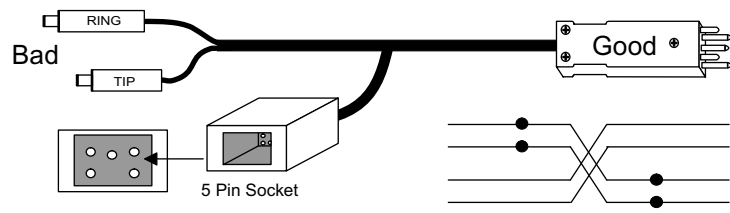
FEATURES / APPLICATION	PART #	DESCRIPTION
<p>Bantam Looping Plug</p> <ul style="list-style-type: none"> 3 conductor looping plug 	<p>400210LP</p> <p>VZ ID # 1100 7945</p>	<p>BANTAM LOOPING PLUG</p> 
<p>Bantam Terminating Plug</p> <ul style="list-style-type: none"> 100 ohm terminating plug 	<p>400210TP-1</p> <p>VZ ID # 8721 3871</p>	<p>BANTAM TERMINATING PLUG</p> 
<p>310 Looping Plug</p> <ul style="list-style-type: none"> 3 conductor looping plug 	<p>400310LP</p> <p>VZ ID # 8702 8137</p>	<p>310 LOOPING PLUG</p> 
<p>310 Terminating Plug</p> <ul style="list-style-type: none"> 100 ohm terminating plug 	<p>400310TP-1</p> <p>VZ ID # 8702 8095</p>	<p>310 TERMINATING PLUG</p> 
<p>310 (female) to Bantam Conversion Cord, (12")</p> <ul style="list-style-type: none"> 310 Plugs into adapter converting to Bantam 	<p>400238-12</p> <p>VZ ID # 8702 8140</p>	<p>310 to BANTAM CONVERSION CORD</p>  <p style="text-align: center;">310 400238-12</p>
<p>Bantam to 310 Conversion Plug</p> <p>Bantam to 310 Conversion Plug, Black</p> <p>Bantam to 310 Conversion Plug, Red</p> <ul style="list-style-type: none"> Slides over Bantam Plug converting it to a 310 	<p>PART # VZ ID #</p> <p>400239 8703 1594</p> <p>400239BK 1105 3690 - Bk</p> <p>400239RD 1105 3689 - Rd</p>	<p>BANTAM TO 310 CONVERSION PLUG</p>  <p style="text-align: center;">BANTAM 400239, 400239RD or 400239BK</p>

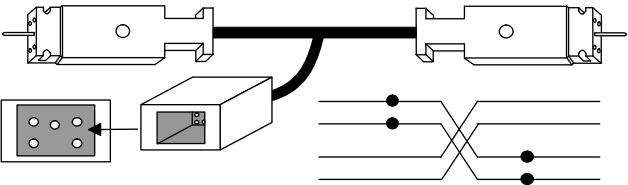
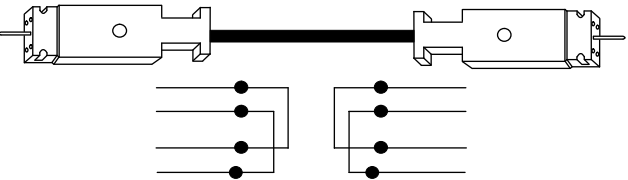
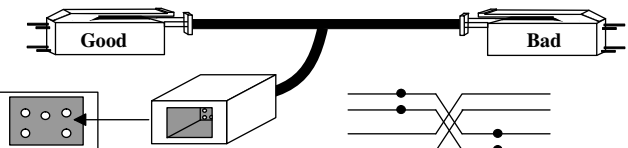

FEATURES / APPLICATION	PART #	DESCRIPTION
<p>Protector to Protector "Frogging" Test Cord, (10')</p> <ul style="list-style-type: none"> Quickly isolate trouble; cable or equipment at MDF or RT "Full Duplex Frog" 	<p>400300F</p> <p>VZ ID # 1100 7875</p>	<p>PROTECTOR "FROGGING" CORD</p> 
<p>Protector to Protector "Frogger" with "In-Line Protection"</p> <ul style="list-style-type: none"> Frogger with In-Line Protection Ideal for quick temporary restoral with "protection" 	<p>400300FP-04, 400300FP-08 400300FP-16, 400300FP-20</p> <p>VZ ID # 1104 3235 4' 1104 3234 8' 1104 3233 16' 1100 7876 20'</p>	<p>FROGGER W/ IN-LINE PROTECTION</p> 
<p>Protector to Protector "Looping" Test Cord, (10")</p> <ul style="list-style-type: none"> At "Remote Terminal" or MDF to quickly isolate troubles Loops both ways 	<p>400300L</p> <p>VZ ID # 1100 7878</p>	<p>PROTECTOR "LOOPING" PLUG</p> 
<p>Protector (non-bridging) to (2) Alligator Clips, (3')</p> <ul style="list-style-type: none"> Test access at (coils) 	<p>400300S-03</p> <p>VZ ID # 1100 7830</p>	<p>PROTECTOR to ALLIGATOR CLIPS</p> 

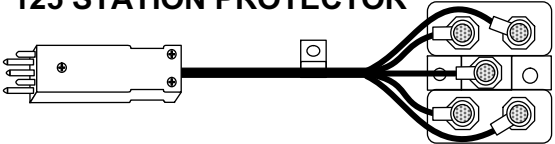
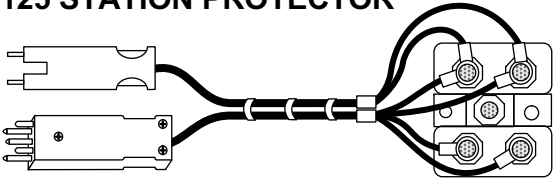



FEATURES / APPLICATION	PART #	DESCRIPTION
<p>252 type plug to 252 type plug "Frogger" with In-Line Protection, (20')</p> <ul style="list-style-type: none"> Frogger with In-Line Protection Ideal for quick temporary restoral with "protection" on older frames 	<p>400252FP</p> <p>VZ ID # 1100 7872</p>	<p>252 "FROGGER" w/ IN-LINE PROTECTION</p> 
<p>412 type plug to 412 type plug "Frogger" with In-Line Protection, (20')</p> <ul style="list-style-type: none"> Frogger with In-Line Protection Ideal for quick temporary restoral with "protection" on older frames 	<p>400412FP</p> <p>VZ ID # 1100 7883</p>	<p>412 "FROGGER" w/ IN-LINE PROTECTION</p> 
<p>252 to 412 Protector "Frogger" with In-Line Protection, (20')</p> <ul style="list-style-type: none"> Conversion Frogger (252 to 412) with In-Line Protection <u>252 side is labeled "GOOD"</u> 	<p>400254FP1</p> <p>VZ ID # 1100 7873</p>	<p>252 to 412 "FROGGER" w/ IN-LINE PROTECTION</p> 
<p>252 to 412 Protector "Frogger" with In-Line Protection, (20')</p> <ul style="list-style-type: none"> Conversion Frogger (252 to 412) with In-Line Protection <u>252 side is labeled "BAD"</u> 	<p>400254FP2</p> <p>VZ ID # 1100 7874</p>	<p>252 to 412 "FROGGER" w/ IN-LINE PROTECTION</p> 

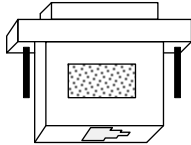
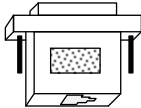
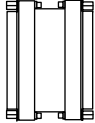
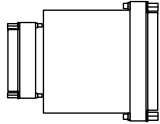





FEATURES / APPLICATION	PART #	DESCRIPTION
<p>252 type plug to 5 Pin plug "Frogger" with "In Line Protection", (20')</p> <ul style="list-style-type: none"> • Frogger with In-Line Protection • Ideal for quick temporary restoral with "protection" on older frames • 252 side is labeled "GOOD" 	<p>400234FP1</p> <p>VZ ID # 1100 7870</p>	<p>252 to 5 PIN FROGGER w/ IN-LINE PROTECTION</p> 
<p>252 type plug to 5 Pin plug "Frogger" with "In Line Protection", (20')</p> <ul style="list-style-type: none"> • Frogger with In-Line Protection • Ideal for quick temporary restoral with "protection" on older frames • 252 side is labeled "BAD" 	<p>400234FP2</p> <p>VZ ID # 1100 7871</p>	<p>252 to 5 PIN " FROGGER w/ IN-LINE PROTECTION</p> 
<p>412 type plug to 5 Pin plug "Frogger" with "In Line Protection", (20')</p> <ul style="list-style-type: none"> • Conversion Frogger (252 to 412) with In-Line Protection • 412 side is labeled "GOOD" 	<p>400434FP1</p> <p>VZ ID # 1100 7884</p>	<p>412 to 5 PIN "FROGGER" w/ IN-LINE PROTECTION</p> 
<p>412 type plug to 5 Pin plug "Frogger" with "In Line Protection", (20')</p> <ul style="list-style-type: none"> • Conversion Frogger (252 to 412) with In-Line Protection • 412 side is labeled "BAD" 	<p>400434FP2</p> <p>VZ ID # 1100 7885</p>	<p>412 to 5 PIN "FROGGER" w/ IN-LINE PROTECTION</p> 



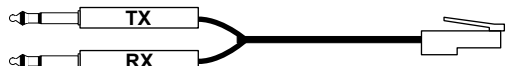

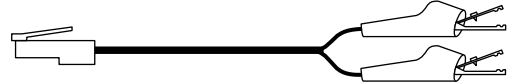
FEATURES / APPLICATION	PART #	DESCRIPTION
<p>Protector (non-bridging) to (2) Alligator Clips, (8') Protector (bridging) to (2) Alligator Clips, (8')</p> <ul style="list-style-type: none"> • Test access at Porta Frame (coils) 	<p>400300SP 400300SMP</p> <p>VZ ID # 1100 7881 SP 1100 7880 SMP</p>	<p>PORTA to ALLIGATOR CLIPS</p> 
<p>Protector to Protector "Frogger" with In-Line Protection, (20')</p> <ul style="list-style-type: none"> • Frogger with In-Line Protection • Ideal for quick temporary restoral with "protection" 	<p>400300FPP</p> <p>VZ ID # 1100 7877</p>	<p>PORTA "FROGGER" w/ IN-LINE PROTECTION</p> 
<p>Protector to Protector "Looping" Test Cord, (10')</p> <ul style="list-style-type: none"> • At "Remote Terminal" or MDF to quickly isolate troubles • Loops both ways 	<p>400300LP</p> <p>VZ ID # 1100 7879</p>	<p>PORTA "LOOPING" CORD</p> 
<p>NTI QMP Protector "Frogger" with "In Line Protection", (20')</p> <ul style="list-style-type: none"> • Frogger with In-Line Protection • Ideal for quick temporary restoral with "protection" 	<p>400300FP-NT</p> <p>VZ ID # 1106 5308</p>	<p>NTI QMP "FROGGER" w/ IN-LINE PROTECTION</p> 
<p>NTI QMP Protector (non-bridging) to (2) Alligator Clips, (8')</p> <ul style="list-style-type: none"> • Test access at coils 	<p>400300S-NT</p> <p>VZ ID # 1132 9577</p>	<p>NTI QMP PROTECTOR to ALLIGATOR CLIPS</p> 



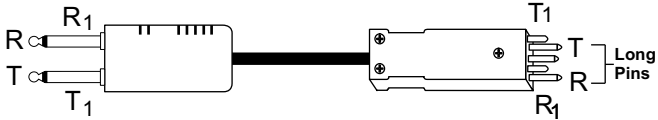

FEATURES / APPLICATION	PART #	VZ ID #	DESCRIPTION
<p>Protector to 125 type Station Protector, (10')</p> <ul style="list-style-type: none"> Cabinet mounting assembly for performing line tests on SLC-96 & Series 5 	T-W4DG-10	1100 7925	<p>PROTECTOR to 125 STATION PROTECTOR</p> 
<p>Protector/526A plug to 125 type Station Protector, (10')</p> <ul style="list-style-type: none"> Cabinet mounting assembly for performing line tests on SLC-96 & Series 5 	T-6W3F-10	1100 7887	<p>PROTECTOR/526A to 125 STATION PROTECTOR</p> 
<p>HDSL Provisioning Test Cord, (6') HDSL Provisioning Test Cord, (25')</p> <ul style="list-style-type: none"> DB 9 Pin (male) to DB 25 Pin (male) for HDSL provisioning from "Dumb" terminals 	400703H-06 400703H-25	1104 1059 1128 9219	<p>HDSL PROVISIONING TEST CORD</p> 
<p>DB 9 Pin (female) to 25 Pin (male), (6') DB 9 Pin (female) to 25 Pin (male), (25')</p> <ul style="list-style-type: none"> IBM AT COM1 Computer Cable 	400703L 400703L-25	1104 1058 1128 9218	<p>9 PIN (female) to 25 PIN (male)</p> 
<p>DB 9 Pin (male) to DB 9 Pin (female), (06') DB 9 Pin (male) to DB 9 Pin (female), (08') DB 9 Pin (male) to DB 9 Pin (female), (10') DB 9 Pin (male) to DB 9 Pin (female), (25') DB 9 Pin (male) to DB 9 Pin (female), (40') DB 9 Pin (male) to DB 9 Pin (female), (50')</p> <ul style="list-style-type: none"> Commonly used from Laptop to test at Pair Gain (HDSL) Wired straight 	400720-06 400720-08 400720-10 400720-25 400720-40 400720-50	1105 4898 1105 4899 8726 3199 1128 9217 1105 4900 1105 4901	<p>9 PIN (male) to 9 PIN (female)</p> 





FEATURES / APPLICATION	PART #	DESCRIPTION
<p>DB 25 Pin (male) to RJ45 Adapter DB 25 Pin (female) to RJ45 Adapter</p> <ul style="list-style-type: none"> 25 Pin Adapter 	<p>400710 400711</p> <p>VZ ID # 8702 8154 1104 7711</p>	<p>25 PIN to RJ45 ADAPTERS</p>  <p>(m) (f)</p>
<p>DB 9 Pin (female) to RJ45 Adapter DB 9 Pin (male) to RJ45 Adapter</p> <ul style="list-style-type: none"> 9 Pin/RJ45 Adapter 	<p>400745 400745M</p> <p>VZ ID # 1104 7710 1106 5379</p>	<p>9 PIN to RJ45 ADAPTERS</p>  <p>(f) (m)</p>
<p>DB 25 Pin (male) to DB 25 Pin (male) Adapter</p> <ul style="list-style-type: none"> 25 Pin Adapter - Gender Changer 	<p>400701</p> <p>VZ ID # 8702 8152</p>	<p>25 PIN (male) to 25 PIN (male) ADAPTER</p> 
<p>9 Pin (Male) to 25 Pin (Female) Adapter 9 Pin (Female) to 25 Pin (Male) Adapter 9 Pin (Male) to 25 Pin (Male) Adapter</p> <ul style="list-style-type: none"> Adapter 	<p>400715 400715FM 400715M</p> <p>VZ ID # 1104 1057 1104 1056 1104 1055</p>	<p>9 PIN to 25 PIN ADAPTER</p>  <p>(m - f) (f - m) (m - m)</p>
<p>DB 9 Pin (female) to DB 9 Pin (female) Adapter</p> <ul style="list-style-type: none"> 9 Pin Adapter - Gender Changer 	<p>400709S</p> <p>VZ ID # 8722 6870</p>	<p>9 PIN (female) to 9 PIN (female) ADAPTER</p> 



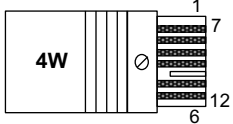

FEATURES / APPLICATION	PART #	DESCRIPTION		
9 Pin (Female) to 25 Pin (Female), (6') <ul style="list-style-type: none"> 9 Pin to 25 Pin conversion cable 	400702	9 PIN (Female) to 25 PIN (Female) 		
VZ ID # 8725 6717				
9 Pin D (Female) to RJ45, (6') 9 Pin D (Female) to RJ45, (10') <ul style="list-style-type: none"> Used from Laptop (9 pin male on Laptop) to Catena Network ADSL card (RJ45 jack on card) 	400722ADSL-06 400722ADSL-10	9 PIN D (Female) to RJ45 		
VZ ID # 1100 7824 6' 1100 7825 10'				
15 Pin D (Male) to RJ48 - (T1), (4') <ul style="list-style-type: none"> T-BERD test set (15 Pin) to Network Interface Unit "Smart Jack" - T1 	400415M-04	15 PIN "D" to RJ48 		
VZ ID # 1100 7838				
DB 9 Pin (Female) to RJ48 (DMX), (6') <ul style="list-style-type: none"> 9 Pin to RJ48 DMX conversion cable 	400740AV	DB 9 PIN (Female) to RJ48 (DMX) 		
VZ ID # 1105 6293				
	PART #	VZ ID #	LENGTH	
9 Pin (Female) to 25 Pin (Male), (6')	400703	8702 8151	6'	9 PIN (Female) to 25 PIN (Male) 
9 Pin (Female) to 25 Pin (Male), (12')	400703-12	1131 9112	12'	
9 Pin (Female) to 25 Pin (Male), (15')	400703-15	1131 9119	15'	
9 Pin (Female) to 25 Pin (Male), (20')	400703-20	1131 9118	20'	
9 Pin (Female) to 25 Pin (Male), (40')	400703-40	1131 6880	40'	
<ul style="list-style-type: none"> IBM AT COM1 Computer Cable 				



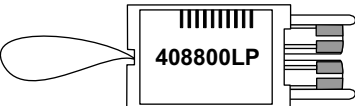
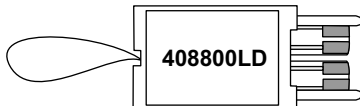

FEATURES / APPLICATION	PART #	VZ ID #	DESCRIPTION
Bantam "Y" (Tx & Rx) to RJ48 - (T1), (8') <ul style="list-style-type: none"> (Tx & Rx) from Network Interface Unit "Smart Jack" - T1, or from DDS (RJ48S) 	400248	369568	BANTAM "Y" to RJ48 
310 "Y" to RJ48 - (T1), (8') <ul style="list-style-type: none"> (TX & RX) from Network Interface Unit TX (Tip=5, Ring=4) RX (Tip=2, Ring=1) 	400348	1100 7866	310 "Y" to RJ48 
RJ48 to RJ48, (3') <ul style="list-style-type: none"> 8P8C Modular plug to 8P8C Modular plug Round cable, Wired 1 to 1 - straight 	400448	1100 7861	RJ48 to RJ48 
RJ48 to RJ48, (6') <ul style="list-style-type: none"> Cord Patch RJ45 10 Base T 	400448BT	1100 7863	RJ48 to RJ48 
RJ45 to 6A Alligator Clips, (6') <ul style="list-style-type: none"> General Purpose Test Cord - ISDN (Tip - Pin 5, Ring - Pin 4) 	400448A2	1100 7862	RJ45 to 6A ALLIGATOR CLIPS 
RJ11 to Alligator Clips, (6') <ul style="list-style-type: none"> Can be used as a DSL / Caller ID test cord 	400268MA	1104 3805	RJ11 to ALLIGATOR CLIPS 
RJ11 to Mini Alligator Clips, (6') <ul style="list-style-type: none"> Alligator Clip Access to RJ11 (Pins 3, 4 Green/Red) 	400269MA	1104 9112	RJ11 to MINI ALLIGATOR CLIPS 
RJ11 to 6P Alligator Clips, (6') <ul style="list-style-type: none"> Standard Line Cord (RJ11 - Pins 3 & 4) to 6P Alligator Clips (Bed of Nails/Spike) 	400511OSP	8725 1328	RJ11 to 6P ALLIGATOR CLIPS 





FEATURES / APPLICATION	PART #	DESCRIPTION
<p>Dual 310 (327) plug to Protector, (16')</p> <ul style="list-style-type: none"> Used to make In/Out tests from 302/308 type connectors Equivalent to W4BR 	<p>T-W4BR</p> <p>VZ ID # 1100 7924</p>	<p>DUAL 310 (327) to PROTECTOR</p> 
<p>Dual 310 to (non-bridging) Porta, (8')</p> <ul style="list-style-type: none"> Commonly used with T1 Repeater Powering Unit 	<p>400310DSP</p> <p>VZ ID # 1104 9136</p>	<p>DUAL 310 to PORTA</p> 
<p>Dual Bantam to (non-bridging) Porta, (8')</p> <ul style="list-style-type: none"> Commonly used with T1 Repeater Powering Unit 	<p>400210DS-P</p> <p>VZ ID # 8724 7083</p>	<p>DUAL BANTAM to PORTA</p> 
<p>Protector to Alligator Clips, (3')</p> <ul style="list-style-type: none"> 463 type plug (protector) to alligator clips Equivalent to W2GL 	<p>T-W2GL</p> <p>VZ ID # 1100 7923</p>	<p>PROTECTOR to ALLIGATOR CLIPS</p> 
<p>Krone (non-bridging) to (2) Alligator Clips, (3') Krone (non-bridging) to (4) Alligator Clips, (3')</p> <ul style="list-style-type: none"> Access to Krone connector blocks to test Central Office Equipment (COE) or Customer Premise Equipment (CPE) 	<p>400300K 400300K4A</p> <p>VZ ID # 7500 6668 (2 alligators) VZ ID # 7500 6669 (4 alligators)</p>	<p>KRONE (non-bridging) to ALLIGATOR CLIPS</p> 





FEATURES / APPLICATION	PART #	DESCRIPTION
<p>Mueller Clip 25C to Mueller Clip 25C, (25')</p> <ul style="list-style-type: none"> Retractable "coil" cord used with 188A test set Equivalent to W1BU-3 	<p>T-W1BU-3</p> <p>VZ ID # 1100 7922</p>	<p>MUELLER CLIP TO MUELLER CLIP</p> 
<p>Dual Banana to Mini Test Clips, (6')</p> <ul style="list-style-type: none"> Access to various connectors, wire wrap terminals 	<p>400440DT</p> <p>VZ ID # 1104 0969</p>	<p>DUAL BANANA TO MIINI TEST CLIPS</p> 
<p>RJ11 to Mini Alligator Clips / Wire Wraps, (6')</p> <ul style="list-style-type: none"> Cord Combi Test for Caller ID 	<p>BA-CITC</p> <p>VZ ID # 1100 7888</p>	<p>RJ11 to MINI ALLIGATOR CLIPS / WIRE WRAPS</p> 
<p>15 Pin (female) to LIU "low profile" connector, (8')</p> <ul style="list-style-type: none"> Connects Power Panel to LIU for test jack access "Low Profile" allows greater door clearance at SLC cabinets 	<p>400442FL</p> <p>VZ ID # 1131 9121</p>	<p>15 PIN (female) to LIU - LOW PROFILE</p> 
<p>15 Pin (female) to LIU connector, (8')</p> <ul style="list-style-type: none"> Connects Power Panel to LIU for test jack access 	<p>400442F</p> <p>VZ ID # 1131 9120</p>	<p>15 PIN (female) to LIU</p> 
<p>D4 (4W Looping Looping Plug)</p> <ul style="list-style-type: none"> Plugs into a 4 wire voice frequency channel unit Used in conjunction with an Extender, excellent for testing tandems 	<p>400488LP</p> <p>VZ ID # 8726 0379</p>	<p>D4 (4W LOOPING PLUG)</p> 





FEATURES / APPLICATION	PART #	Material ID #	DESCRIPTION
<p>800 DSX to 800 DSX, (12')</p> <ul style="list-style-type: none"> 800 DSX Patch Cord 	408800-12	1100 7865	<p>800 DSX to 800 DSX</p> 
<p>Bantam to 800 DSX, (6')</p> <p>Bantam to 800 DSX, (12')</p> <p>Bantam to 800 DSX, (20')</p> <p>Bantam to 800 DSX, (25')</p> <p>Bantam to 800 DSX, (30')</p> <ul style="list-style-type: none"> Test equipment access to 800 DSX 	<p>408210</p> <p>408210-12</p> <p>408210-20</p> <p>408210-25</p> <p>408210-30</p>	<p>8702 8101</p> <p>8726 6823</p> <p>8726 4351</p> <p>8702 8106</p> <p>8724 5788</p>	<p>BANTAM to 800 DSX</p> 
<p>310 to 800 DSX, (6')</p> <p>310 to 800 DSX, (12')</p> <p>310 to 800 DSX, (15')</p> <p>310 to 800 DSX, (25')</p> <ul style="list-style-type: none"> Test equipment access to 800 DSX 	<p>408310</p> <p>408310-12</p> <p>408310-15</p> <p>408310-25</p>	<p>8702 8126</p> <p>8722 1850</p> <p>8728 3695</p> <p>8721 2267</p>	<p>310 to 800 DSX</p> 
 <p>408800TP-1 800 DSX Terminating Plug</p> <ul style="list-style-type: none"> Available in 100 ohm 	 <p>408800LP 800 DSX Looping Plug</p> <ul style="list-style-type: none"> "Loops" in ONE Direction 	 <p>408800LD 800 DSX Looping Plug</p> <ul style="list-style-type: none"> Loops both directions 	<p>VZ ID # 8721 3867</p>
<p>VZ ID # 8727 4414</p>		<p>VZ ID # 8702 9510</p>	

FEATURES / APPLICATION	PART #	DESCRIPTION
<p>Bantam "Y" to 800 Duplex (White Cord), (6') Bantam "Y" to 800 Duplex (White Cord), (12')</p> <ul style="list-style-type: none"> • "WHITE CORD" establishes a "Near-Side" connect • Disconnects "Far-Side" 	<p>408801 408801-12</p> <p>VZ ID # 8702 8108 6' 8702 8109 12'</p>	<p>BANTAM "Y" to 800 DUPLEX (WHITE CORD)</p> 
<p>310 "Y" to Duplex (White Cord), (6')</p> <ul style="list-style-type: none"> • "WHITE CORD" establishes a "Near-Side" connect • Disconnects "Far-Side" 	<p>408802</p> <p>VZ ID # 8722 7400</p>	<p>310 "Y" to 800 DUPLEX (WHITE CORD)</p> 
<p>Bantam "Y" to 800 Duplex (Blue Cord), (6')</p> <ul style="list-style-type: none"> • "BLUE CORD" establishes a "Far-Side" connect • Disconnects "Near-Side" 	<p>408803</p> <p>VZ ID # 396096</p>	<p>BANTAM "Y" to 800 DUPLEX (BLUE CORD)</p> 
<p>310 "Y" to 800 Duplex (Blue Cord), (6')</p> <ul style="list-style-type: none"> • "BLUE CORD" establishes a "Far-Side" connect • Disconnects "Near-Side" 	<p>408804</p> <p>VZ ID # 8722 7401</p>	<p>310 "Y" to 800 DUPLEX (BLUE CORD)</p> 

FEATURES / APPLICATION	PART #	DESCRIPTION
Bantam "Y" to 800 Duplex (Orange Cord), (6') Bantam "Y" to 800 Duplex (Orange Cord), (12')	408805 408805-12	BANTAM "Y" to 800 DUPLEX (ORANGE CORD)
<ul style="list-style-type: none"> "ORANGE CORD" monitors both directions 	VZ ID # 1106 2276 6' 8729 1209 12'	
310 "Y" to 800 Duplex (Orange Cord), (6') 310 "Y" to 800 Duplex (Orange Cord), (10') 310 "Y" to 800 Duplex (Orange Cord), (12')	408806 408806-10 408806-12	310 "Y" to 800 DUPLEX (ORANGE CORD)
<ul style="list-style-type: none"> "ORANGE CORD" monitors both directions 	VZ ID # 8702 8111 6' 8727 3494 10' 8729 1210 12'	
Dual Bantam to 800 Duplex (White Cord), (6') Dual Bantam to 800 Duplex (White Cord), (25') Dual Bantam to 800 Duplex (White Cord), (50')	408210DD 408210DD-25 408210DD-50	DUAL BANTAM to 800 DUPLEX (WHITE CORD)
<ul style="list-style-type: none"> "WHITE CORD" establishes a "Near -Side" connect Disconnects "Far-Side" 	VZ ID # 1106 2277 6' 8727 4979 25' 8727 4983 50'	
	<u>PART #</u>	<u>VZ ID #</u>
800 Duplex to 800 Duplex, (6')	408800D	8721 7278 6'
800 Duplex to 800 Duplex, (12')	408800D-12	8725 6801 12'
800 Duplex to 800 Duplex, (20')	408800D-20	8727 5918 20'
800 Duplex to 800 Duplex, (25')	408800D-25	8722 2816 25'
800 Duplex to 800 Duplex, (30')	408800D-30	8727 5919 30'
800 Duplex to 800 Duplex, (40')	408800D-40	8727 5920 40'
800 Duplex to 800 Duplex, (50')	408800D-50	8724 1222 50'
800 Duplex to 800 Duplex, (75')	408800D-75	8725 8389 75'
<ul style="list-style-type: none"> 800 DSX Patch Cord 		
	800 DUPLEX to 800 DUPLEX	
		

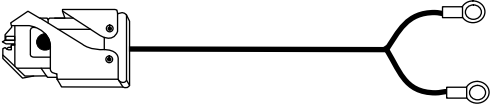
FEATURES / APPLICATION	PART #	DESCRIPTION
<p>Dual 327C Plug to 463A, (20')</p> <ul style="list-style-type: none"> • Frame cord - used from jack panels to CAS/C pair (protector) on Vertical side of MDF 	<p>F44-CJ-20</p> <p>VZ ID # 1100 7930</p>	<p>FRAME CORD, 5 PIN - RED</p> 
<p>Dual 327C Plug to Mini Porta, (20')</p> <ul style="list-style-type: none"> • Frame cord - used from jack panels to CAS/C pair (protector) on Vertical side of MDF 	<p>F44-CJPM-20</p> <p>VZ ID # 1100 7931</p>	<p>FRAME CORD, 1 PIN MINI PORTA - RED</p> 
<p>Dual 327C Plug to Porta, (20')</p> <ul style="list-style-type: none"> • Frame cord - used from jack panels to CAS/C pair (protector) on Vertical side of MDF 	<p>F44-CJP-20</p> <p>VZ ID # 1105 2922</p>	<p>FRAME CORD, 1 PIN PORTA - RED</p> 
<p>Dual 327C Plug to 412A/412B, (20')</p> <ul style="list-style-type: none"> • Frame cord - used from jack panels to CAS/C pair (protector) on Vertical side of MDF 	<p>F44-412-20</p> <p>VZ ID # 1100 7929</p>	<p>FRAME CORD, 412 PLUGS - RED</p> 

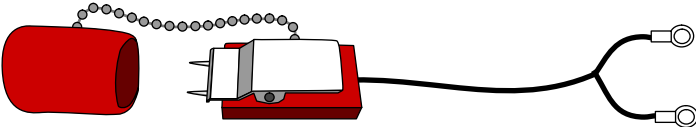
FEATURES / APPLICATION	PART #	DESCRIPTION
<p>Dual 327C Plug to Northern Telecom QMP Plug, (20')</p> <ul style="list-style-type: none"> • Frame cord - used from jack panels to CAS/C pair (protector) on Vertical side of MDF 	<p>F44-NT-20</p> <p>VZ ID # 1100 7932</p>	<p>FRAME CORD, NORTHERN TELECOM QMP PLUG - RED</p> 
<p>Dual 327C Plug to 301A, (20')</p> <ul style="list-style-type: none"> • Frame cord - used from jack panels to CAS/C pair (protector) on Vertical side of MDF 	<p>F44-301A-20</p> <p>VZ ID # 1100 7928</p>	<p>FRAME CORD, 301A PLUG - RED</p> 
<p>Dual 327C Plug to Northern Telecom Plug, (20')</p> <ul style="list-style-type: none"> • Frame cord - used from jack panels to CAS/C pair (protector) on Vertical side of MDF 	<p>F44-NTM-20</p> <p>VZ ID # 1100 7933</p>	<p>FRAME CORD, NORTHERN TELECOM MINI PLUG - RED</p> 
<p>Dual 327C Plug to 252A/252B, (20')</p> <ul style="list-style-type: none"> • Frame cord - used from jack panels to CAS/C pair (protector) on Vertical side of MDF 	<p>F44-252-20</p> <p>VZ ID # 1100 7927</p>	<p>FRAME CORD, 252 PLUGS - RED</p> 
<p>Dual 327C Plug to Wire Wraps, (20')</p> <ul style="list-style-type: none"> • Frame cord - used from jack panels to CAS/C pair (protector) on Vertical side of MDF 	<p>F44-WP-20</p> <p>VZ ID # 1100 7934</p>	<p>FRAME CORD, WIRE WRAPS - RED</p> 

FEATURES / APPLICATION	PART #	DESCRIPTION
<p>D Clip to Round Lugs, (4')</p> <ul style="list-style-type: none"> Used from various test sets at 88, 110 type connectors 	<p>400110SL</p> <p>VZ ID # 1126 1121</p>	<p>D CLIP to ROUND LUGS</p> 
<p>76 Clip to Round Lugs, (4')</p> <ul style="list-style-type: none"> Used from various test sets at 76 type connectors 	<p>400276RL</p> <p>VZ ID # 1126 1120</p>	<p>76 CLIP to ROUND LUGS</p> 
<p>BT 25 Plug to Round Lugs, (5')</p> <ul style="list-style-type: none"> Used from various test sets at BT 25 Blocks 	<p>400276BT25</p> <p>VZ ID # 1126 1119</p>	<p>BT 25 PLUG to ROUND LUGS</p> 
<p>RLS Plug to Round Lugs, (8')</p> <ul style="list-style-type: none"> Used for testing Reltec Systems 	<p>400196RL-08</p> <p>VZ ID # 7501 4966</p>	<p>RLS PLUG to ROUND LUGS</p> 
<p>317 Pair Clip to Round Lugs, (8')</p> <ul style="list-style-type: none"> Used with butt sets to test on Reltec distribution points 	<p>400317RL-08</p> <p>VZ ID # 7501 4967</p>	<p>317 PAIR CLIP to ROUND LUGS</p> 

PART # 2-ADE-5

471A Jack to Alligator Clips / 463A Protector / 453A, (5')

VZ ID # 1106 2881

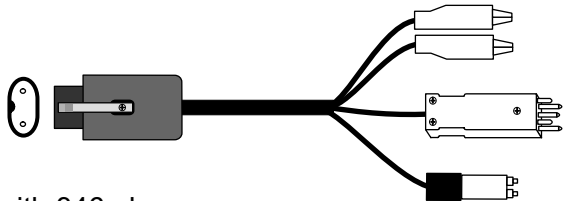

- Mates with 346 plug (Quick Disconnect Butt-Sets)

PART # 2-ACH-4

471A Jack to Alligator Clips / Wire Wraps/ 526A, (4')

VZ ID # 1125 8426

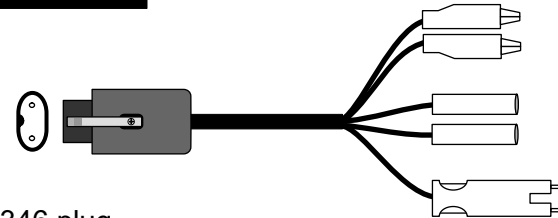

- Mates with 346 plug (Quick Disconnect Butt-Sets)

PART # 2-ACGH-4

471A Jack to Alligator Clips / Wire Wraps / 310 / 526A, (4')

VZ ID # 1125 8425

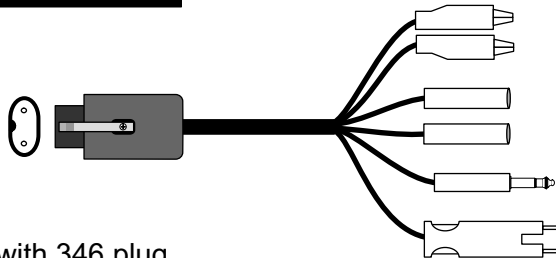

- Mates with 346 plug (Quick Disconnect Butt-Sets)

PART # 2-ACEHP-4

471A Jack to Alligator Clips / Wire Wraps / 453A / 526A / 310 MDF, (4')

- Mates with 346 plug (Quick Disconnect Butt-Sets)

VZ ID # 1125 8427

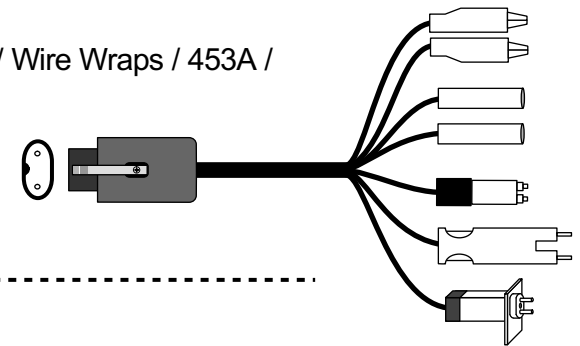

PART # 4-ACEHP-4

Weatherproof Hardwire to Alligator Clips / Wire Wraps / 453A / 526A / 310 MDF, (4') - (not shown)

- Use with Deluxe Weatherproof Butt-Sets

VZ ID # 7500 7583

TAG CAN MAKE BUTT-SET MULTI-CORDS SPECIFICALLY TO YOUR DESIGN
PLEASE CALL 856-753-8585 FOR MORE INFORMATION
OR VISIT WWW.TAGCORDS.COM

PART # 400471WP







471A Jack to Wire Wraps, (3')

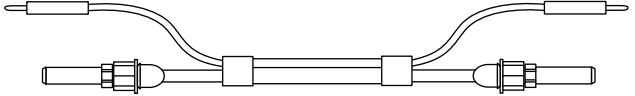
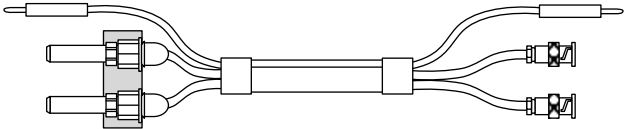
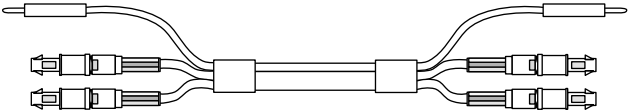



VZ ID # 700 264 311

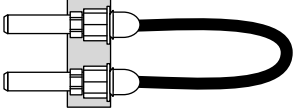
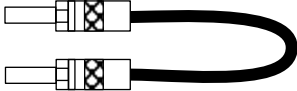

- Mates with 346 plug (Quick Disconnect Butt-Sets)

FEATURES / APPLICATION	PART #	VZ ID #	DESCRIPTION
<p>440D to 440D w / Tracer, (10')</p> <p>440D to 440D w / Tracer, (16')</p> <ul style="list-style-type: none"> Used for loop-back or patching Available in various lengths 	<p>400440D-10</p> <p>400440D-16</p>	<p>8722 0617</p> <p>1125 8969</p>	<p>440D to 440D w/ TRACER</p> 
<p>Dual 440D to Dual BNC w/ Tracer, (6')</p> <p>Dual 440D to Dual BNC w/ Tracer, (10')</p> <p>Dual 440D to Dual BNC w/ Tracer, (12')</p> <p>Dual 440D to Dual BNC w/ Tracer, (20')</p> <p>Dual 440D to Dual BNC w/ Tracer, (30')</p> <ul style="list-style-type: none"> Used for DSX-3/4 with commercial DSX-3 frames that have BNC jacks for cross-connections 	<p>400440DR-06</p> <p>400440DR-10</p> <p>400440DR-12</p> <p>400440DR-20</p> <p>400440DR-30</p>	<p>8726 9855</p> <p>1108 9984</p> <p>1105 2058</p> <p>1108 9985</p> <p>1108 9986</p>	<p>DUAL 440D to DUAL BNC w/ TRACER</p> 
<p>Dual LCC to Dual LCC w/ Tracer, (10')</p> <p>Dual LCC to Dual LCC w/ Tracer, (15')</p> <p>Dual LCC to Dual LCC w/ Tracer, (20')</p> <p>Dual LCC to Dual LCC w/ Tracer, (25')</p> <p>Dual LCC to Dual LCC w/ Tracer, (30')</p> <p>Dual LCC to Dual LCC w/ Tracer, (35')</p> <ul style="list-style-type: none"> REAR "locking" cross connection to ADC's Mini DSX 3/4 	<p>400470CC-10</p> <p>400470CC-15</p> <p>400470CC-20</p> <p>400470CC-25</p> <p>400470CC-30</p> <p>400470CC-35</p>	<p>1107 2246</p> <p>1107 2245</p> <p>1108 2290</p> <p>1108 2291</p> <p>1108 2292</p> <p>1108 2293</p>	<p>DUAL LCC to DUAL LCC w/ TRACER</p> 

FEATURES / APPLICATION	PART #	VZ ID #		DESCRIPTION
440A to 440A - Red, (8') 440A to 440A - Black, (8') <ul style="list-style-type: none"> • Coax Patch/Test Cord 	400440ARD-08 400440ABK-08	1100 7951 1100 7950	Red Black	440A to 440A 
440A to 440A - Red, (6') 440A to 440A - Black, (6') <ul style="list-style-type: none"> • Coax Patch/Test Cord 	400440ARD 400440ABK	1105 4723 1105 4724	Red Black	440A to 440A 
440A to BNC - Red, (8') 440A to BNC - Black, (8') <ul style="list-style-type: none"> • Coax Patch/Test Cord 	400440BRD-08 400440BBK-08	1100 7953 1100 7952	Red Black	440A to BNC 
440A to 358A, (6') 440A to 358A - Red, (8') 440A to 358A - Black, (8') <ul style="list-style-type: none"> • Coax Patch/Test Cord 	440358A-06 440358ARD-08 440358ABK-08	1125 8968 1100 7955 1100 7954	Red Black	440A to 358A 
BNC to BNC, (1') BNC to BNC, (50') <ul style="list-style-type: none"> • General purpose test cord 	400600-01 400600-50	1104 1391 1106 7569	1' 50'	BNC to BNC 
BNC Coupler <ul style="list-style-type: none"> • Extension for standard BNC (male) cords 	BNC-C	1125 8966		BNC COUPLER 

FEATURES / APPLICATION	PART #	VZ ID #	DESCRIPTION
<p>440D Loopback Plug (molded)</p> <ul style="list-style-type: none"> 440D Loopback plug 	400440DLM	1104 1393	<p>440D LOOPBACK PLUG (MOLDED)</p> 
<p>440D Loopback Plug</p> <ul style="list-style-type: none"> 440D Loopback plug 	400440DLP	8725 1533	<p>440D LOOPBACK PLUG</p> 
<p>440A (Male) to 440A (Male) Loopback Cord, (8") 440A (Male) to 440A (Male) Loopback Cord, (1')</p> <ul style="list-style-type: none"> Allows a technician to verify the patch cord portion of a DS3 circuit under test 	<p>400440A-R8 400440A-01</p>	<p>1106 6212 1106 8273</p>	<p>440A (Male) LOOPBACK CORD</p> 
<p>440 (Female) to 440 (Female) Loopback Cord, (8")</p> <ul style="list-style-type: none"> Allows a technician to verify the patch cord portion of a DS3 circuit under test 	400440FLP-01	1100 7821	<p>440 (Female) LOOPBACK CORD</p> 
<p>440 (Female) to 440 (Female) Loopback Tool</p> <ul style="list-style-type: none"> Allows a technician to verify the patch cord portion of a DS3 circuit under test 	400440LPT	1100 7822	<p>440 (Female) LOOPBACK TOOL</p> 
<p>BNC (Female) to BNC (Female) Loopback Tool</p> <ul style="list-style-type: none"> Allows a technician to verify the patch cord portion of a DS3 circuit under test 	400600LPT	1100 7823	<p>BNC (Female) LOOPBACK TOOL</p> 

COAX PATCH CORDS

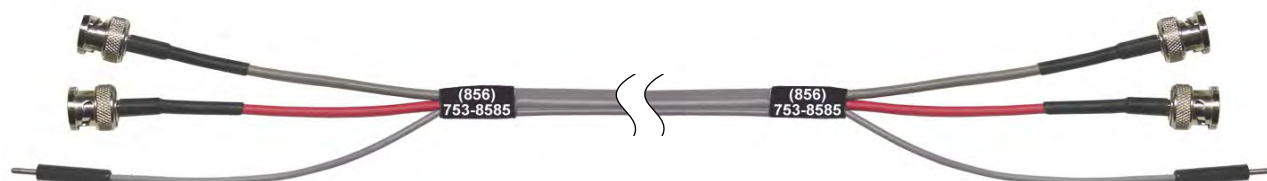

Ordering Information:

		VZ ID #
400440BB-01	Dual BNC to Dual BNC w/ tracer, (1')	1100 7839
400440BB-03	Dual BNC to Dual BNC w/ tracer, (3')	1100 7840
400440BB-05	Dual BNC to Dual BNC w/ tracer, (5')	1100 7841
400440BB-07	Dual BNC to Dual BNC w/ tracer, (7')	1100 7842
400440BB-09	Dual BNC to Dual BNC w/ tracer, (9')	1100 7843
400440BB-10	Dual BNC to Dual BNC w/ tracer, (10')	8721 0460
400440BB-11	Dual BNC to Dual BNC w/ tracer, (11')	1105 4902
400440BB-15	Dual BNC to Dual BNC w/ tracer, (15')	914370
400440BB-19	Dual BNC to Dual BNC w/ tracer, (19')	914374
400440BB-20	Dual BNC to Dual BNC w/ tracer, (20')	1108 9990
400440BB-25	Dual BNC to Dual BNC w/ tracer, (25')	8725 9527
400440BB-30	Dual BNC to Dual BNC w/ tracer, (30')	8728 1688
400440BB-35	Dual BNC to Dual BNC w/ tracer, (35')	1100 7846
400440BB-37	Dual BNC to Dual BNC w/ tracer, (37')	914393
400440BB-40	Dual BNC to Dual BNC w/ tracer, (40')	8721 0473
400440BB-45	Dual BNC to Dual BNC w/ tracer, (45')	1100 7848

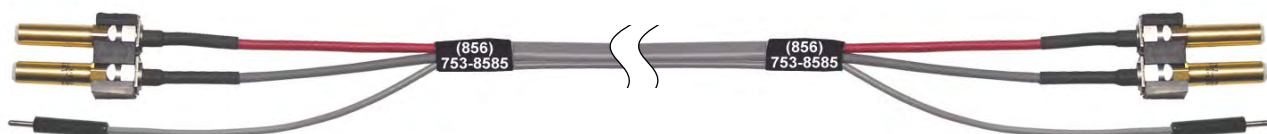

Ordering Information:

		VZ ID #
400440DD-01	Dual 440D to Dual 440D w/ tracer, (1')	8727 0227
400440DD-03	Dual 440D to Dual 440D w/ tracer, (3')	8725 8439
400440DD-05	Dual 440D to Dual 440D w/ tracer, (5')	1100 7852
400440DD-07	Dual 440D to Dual 440D w/ tracer, (7')	8725 6800
400440DD-09	Dual 440D to Dual 440D w/ tracer, (9')	5700 8378
400440DD-10	Dual 440D to Dual 440D w/ tracer, (10')	1108 9987
400440DD-15	Dual 440D to Dual 440D w/ tracer, (15')	8721 8524
400440DD-20	Dual 440D to Dual 440D w/ tracer, (20')	1108 9988
400440DD-25	Dual 440D to Dual 440D w/ tracer, (25')	8721 8527
400440DD-30	Dual 440D to Dual 440D w/ tracer, (30')	1108 9989
400440DD-35	Dual 440D to Dual 440D w/ tracer, (35')	1100 7857
400440DD-40	Dual 440D to Dual 440D w/ tracer, (40')	8726 0897
400440DD-45	Dual 440D to Dual 440D w/ tracer, (45')	1100 7859
400440DD-50	Dual 440D to Dual 440D w/ tracer, (50')	8725 4584

150 Cooper Rd. (F-15)
W. Berlin, NJ 08091

www.tagcords.com

Telephone: (856) 753-8585
Fax : (856) 768-7645

Telecom Assistance Group

Colt 250* / Exfo 635* Test Cords

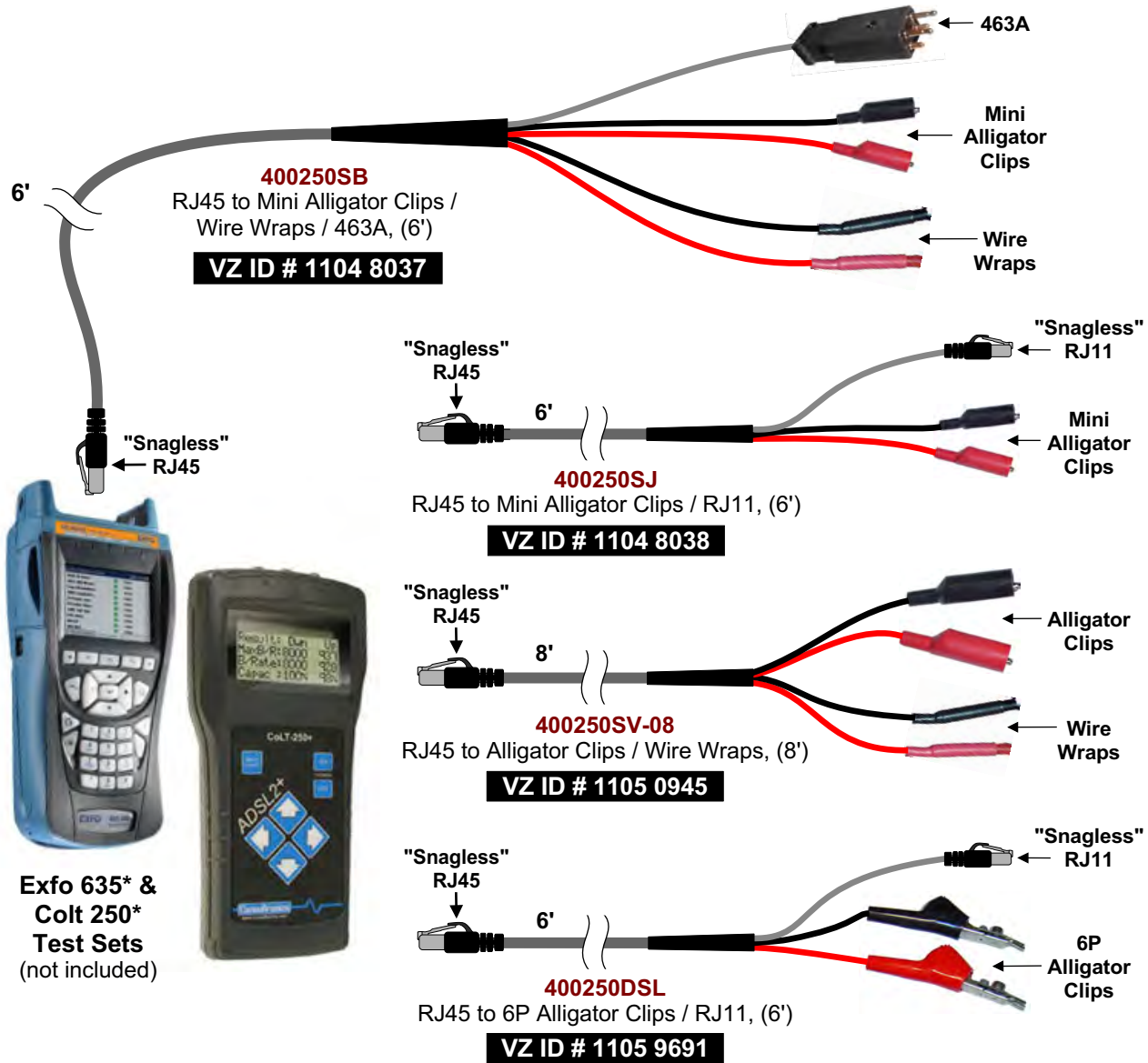

Application:

The cords shown above are used with the Colt 250* and/or Exfo 635* test set to perform DSL testing.

Ordering Information:		VZ ID #
400250SB	RJ45 to Mini Alligator Clips / Wire Wraps / 463A, (6')	1104 8037
400250SJ	RJ45 to Mini Alligator Clips / RJ11, (6')	1104 8038
400250SV-08	RJ45 to Alligator Clips / Wire Wraps, (8')	1105 0945
400250DSL	RJ45 to 6P Alligator Clips / RJ11, (6')	1105 9691

150 Cooper Rd. (F-15)
W. Berlin, NJ 08091

www.tagcords.com

Telephone: (856) 753-8585
Fax : (856) 768-7645

Telecom Assistance Group

Universal 2W/4W Remote HDSL Replacement Cord

4WSL-4A-08

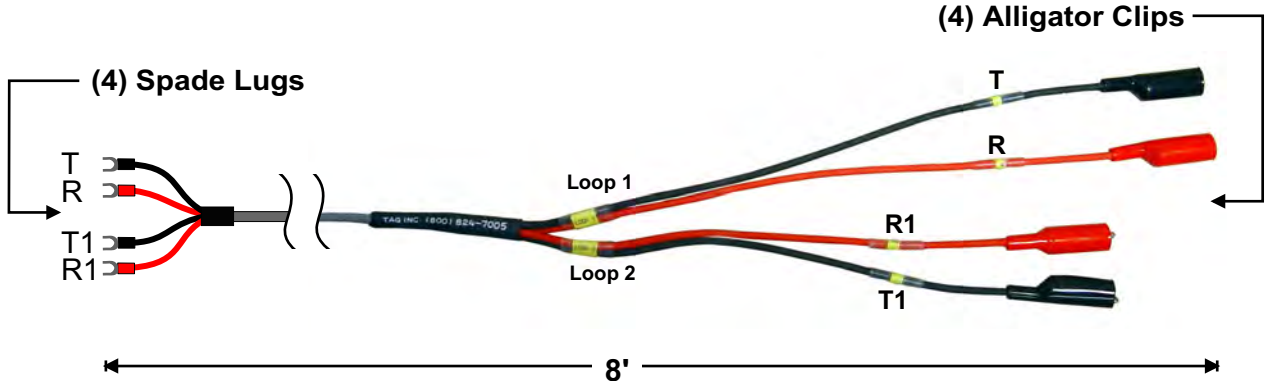

4WSL-4A-08
 Universal 2W/4W
 Remote HDSL Replacement Cord, (8')

VZ ID #
1107 2280



Ordering Information:		VZ ID #
4WSL-4A-08	Universal 2W/4W Remote HDSL Replacement Cord, (8')	1107 2280

150 Cooper Rd. (F-15)
 W. Berlin, NJ 08091

www.tagcords.com

Telephone: (856) 753-8585
 Fax : (856) 768-7645

Telecom Assistance Group

Wire Placement Pole for Standard Frame

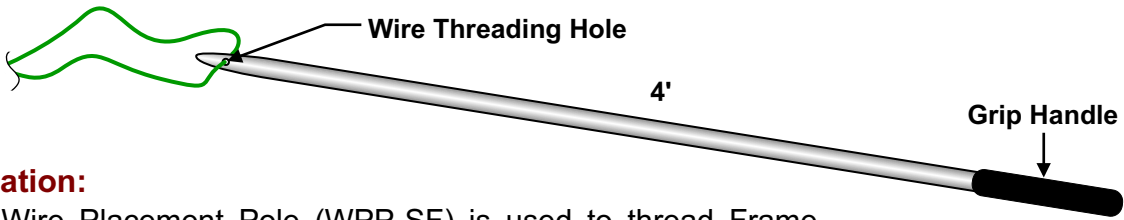

Application:

TAG's Wire Placement Pole (WPP-SF) is used to thread Frame Wire on the Main Distribution Frame (MDF) in the Central Offices.

Ordering Information:		VZ ID #
WPP-SF	Wire Placement Pole for Standard Frame	1107 3239

Wire Reel Brake Replacement

PUT THE BRAKES ON!!!



Wire Reel Brake Replacement
Part # **WR-102BRK**



- ▶ Avoid cross connect wire spool tangles and wasting of wire.
- ▶ The WR-102BRK replaces broken and/or worn-out brakes.

Central Office Wire Reels

Ordering Information:		VZ ID #
WR-102BRK	Cable Reel Brake Assembly w/ Grommet & Brake	1104 3381
WR-102RWK	Rubber Wheel Repair Kit includes: (4) Rubber Wheels & (4) Retaining Spring Clips	1104 7974

150 Cooper Rd. (F-15)
W. Berlin, NJ 08091

www.tagcords.com

Telephone: (856) 753-8585
Fax : (856) 768-7645

Telecom Assistance Group

Apparatus Cases (T1, HDSL, DDS)

Part # EXT-209

VZ ID # 1100 7894

Description: T1 Loopback Extender

- Universal interface to all test sets
- Loops signal and simplex current
- Isolates trouble to repeater or cable
- Bantam Jack access eliminates special probes and cables
- Direct metallic bridging allows current, voltage and loop resistance measurements

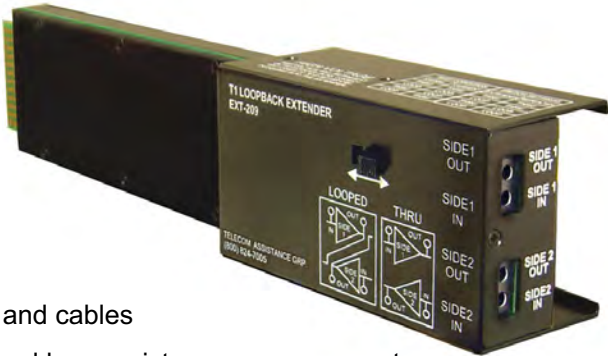

Part # EXT-209T

VZ ID # 1100 7895

Description: T1 Repeater Extender

- Span current test points
- Loops signal and simplex current
- Test repeaters in the field
- Bantam Jack access to monitor/transmit QRSS, 3 in 24 from test sets
- Direct metallic bridging allows current, voltage and loop resistance measurements



T1 / DDS / ISDN Repeater Test Well

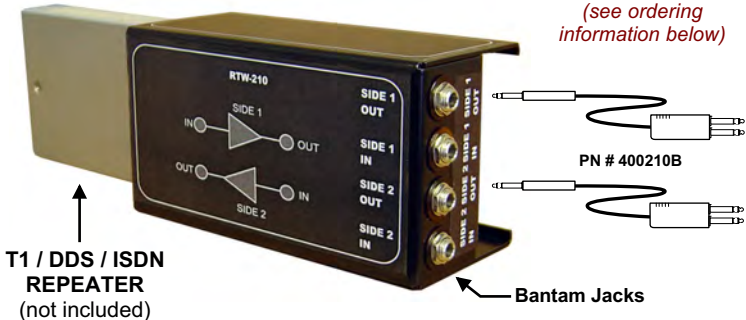

Available with Bantam or 310 Jacks (see ordering information below)

PINS REPEATER

3 & 4	SIDE 1 OUT
5 & 6	SIDE 1 IN
8 & 9	SIDE 2 OUT
11 & 12	SIDE 2 IN

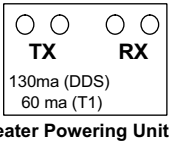

Features:

- T1/DSS/ISDN repeaters fit in test well
- Use BA-RTW-310 / BA-RTW-210 to test T1/DDS/ISDN repeaters before installing in the field

Ordering Information:

BA-RTW-210	T1/DDS/ISDN Repeater Test Well w/ Bantam Jacks	VZ ID # 1100 7905
400210B	Dual Bantam to Bantam, (6')	Call for Pricing
BA-RTW-310	T1/DDS/ISDN Repeater Test Well w/ 310 Jacks (not shown)	1100 7906
400310D	Dual 310 to 310, (6') (not shown)	Call for Pricing

150 Cooper Rd. (F-15)
W. Berlin, NJ 08091

www.tagcords.com

Telecom Assistance Group

Telephone: (856) 753-8585
Fax : (856) 768-7645

T1 Wiring Access Board Kit

KIT-239

(1) # EXT-239E

T1 Wiring Access Board

VZ ID #
1100 7886
(test board only)

KIT VZ ID #
1100 7899

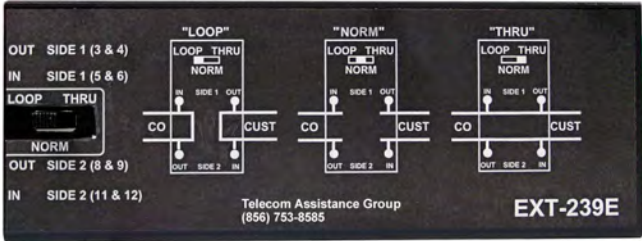

Bantam Jacks **Plugs into T1, 56KB, HDSL, ISDN Apparatus Cases**

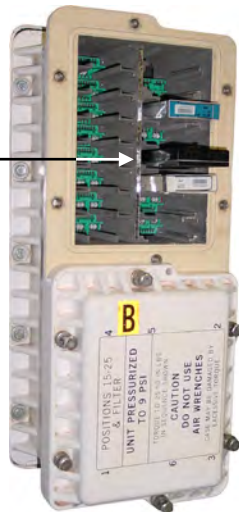

**** Replaces 254A**



(1) # 600209
Carrying Case

VZ ID #
1100 7886

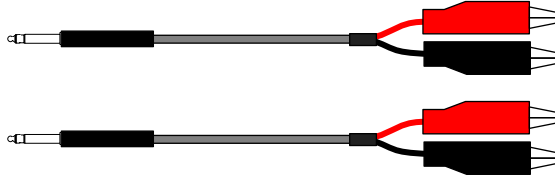

(2) # 400210A-03
Bantam to Alligators, (3')

VZ ID #
VZ ID # 700 229 800*
** ID # is for QTY of 1*

Features:

- Enhanced switch settings for Thru, Norm & Loop testing at T1 line repeater apparatus cases
- Metallic access at T1 line repeater slots
- Use with test sets to perform Cable Loss, Resistance or TDR test set to locate load coils

Ordering Information:

KIT-239

T1 Wiring Access Board Kit

VZ ID #

1100 7899

includes: (1) EXT-239E, (2) 400210A-03, & (1) 600209 - Carrying Case

600209

Carrying Case

1100 7886

EXT-239E

T1 Wiring Access Board

1100 7897

150 Cooper Rd. (F-15)
W. Berlin, NJ 08091

www.tagcords.com

Telephone: (856) 753-8585
Fax : (856) 768-7645

Telecom Assistance Group

CXM Test Kit

EXT-CXM KIT

The CXM Kit is designed for technicians who test at T1 Line Repeater Housings, such as 818 apparatus cases. (see Fig. 1) **The KIT includes:**



(1) # EXT-238
T1 Line Repeater Access Board

- Plugs in "mini" T1 Line Repeater Slots in 818, 819 apparatus cases or other T1 apparatus cases that house (238/239 type repeaters).
- Provides access to wiring via Bantam Jacks.

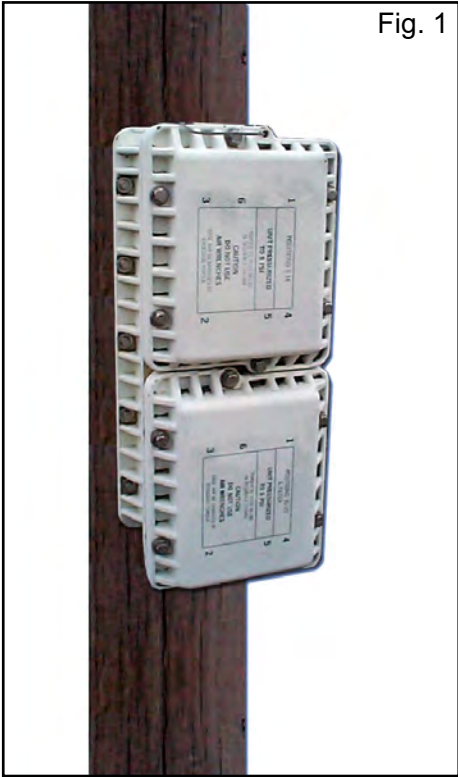

(1) # 600209
Carrying Case



(1) # 400210RD-03
Bantam to Bantam, (3') - Red



(1) # 400210ARD-03
Bantam to Alligator Clips, (3') - Red



(1) # 400210BK-03
Bantam to Bantam, (3') - Black



(1) # 400210ABK-03
Bantam to Alligator Clips, (3') - Black

Ordering Information:

EXT-CXM KIT	CXM Test Kit	VZ ID #
	includes: (1) EXT-338, (1) 400210RD-03, (1) 400210BK-03, (1) 400210ARD-03, (1) 400210ABK-03 & (1) 600209	1100 7898
EXT-238	T1 Line Repeater Access Board	1100 7896
600209	Carrying Case	1100 7886

150 Cooper Rd. (F-15)
W. Berlin, NJ 08091

www.tagcords.com

Telephone: (856) 753-8585
Fax : (856) 768-7645

Telecom Assistance Group

ORB - (HDSL/T1) ORB Shelves

TB-231B (w/ Bantam Jacks) or **TB-231** (w/ Pin Jacks)
220 Office Repeater Test Board

Application:

The TB-231B provides metallic access via bantam jacks to test at office repeater card slots. Utilizing standard test sets and bantam test cords, the TB-231B becomes a powerful tool in testing in the Central Office, Remote Terminals, and CEV's.

Note: The TB-231 provides metallic access via pin jacks commonly used with volt/ohm meters.



Ordering Information:

TB-231B ORB Test Access Board w/ bantam jacks
TB-231 ORB Test Access Board w/ pin jacks

VZ ID #
1100 7915
1100 7914

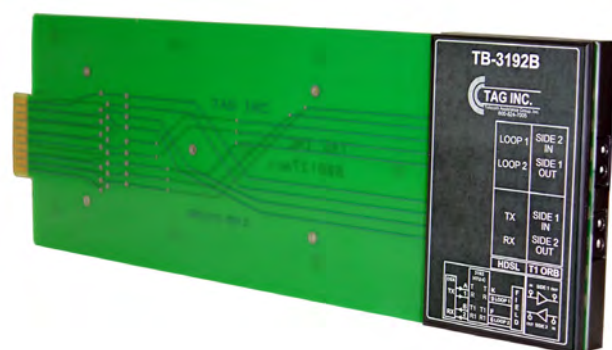

TB-3192B (w/ Bantam Jacks)
3190/3192 Office Repeater Test Board

Application:

The TB-3192B provides metallic test access via bantam jacks or pin jacks in 3190 & 3192 office repeater card slots. The TB-3192B allows test access in the 3190 & 3192 Span Termination System (STS). The TB-3192B becomes a powerful tool in installing and testing 3190 & 3192 card slots for **both HDSL and T1 ORB applications** card slots in Central Offices, Remote Terminals and CEV's.

Ordering Information:

TB-3192B 3190/3192 Office Repeater Test Board w/ bantam jacks
600209 Carrying Case

VZ ID #
1100 7916
1100 7886

ST-3192

3192 Office Repeater Streaker Card (w/ LEDs)

Application:

The ST-3192 provides a quick method to "streak", verify wiring via LEDs, from the 3190 and 3192 Chassis Mechanics backplane. At the frame simply ground the corresponding pins and the ST-3192 will light the LED associated with that connection. The ST-3192 is powered by a 9 volt battery and tests empty card slots in non-powered 3190 and 3192 office repeater card slots.

Ordering Information:

ST-3192 3192 Office Repeater Streaker Card w/ LED's
P-2000 Protected Test Probe w/ LED



VZ ID #
1100 7907
1100 7903

150 Cooper Rd. (F-15)
W. Berlin, NJ 08091

www.tagcords.com

Telecom Assistance Group

Telephone: (856) 753-8585
Fax : (856) 768-7645

HDSL Remote HRU - 200/400 Mechanics

Plugs into Remote HRU HDSL shelves, doublers (200/400 Mechanics)

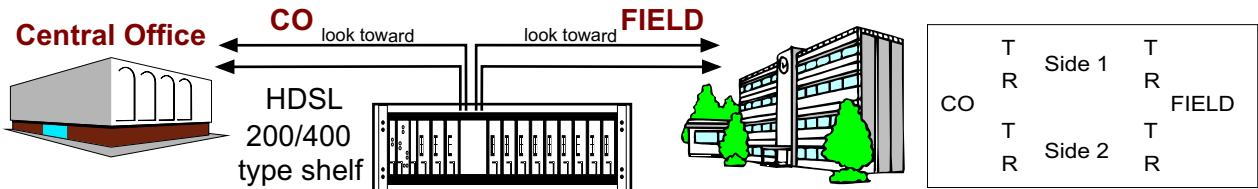

TB-400
200/400 Shelf HDSL Test Board (w/ Pin Jacks)

Application:
The TB-400 (pin jacks) provides metallic access to wiring in 200/400 HDSL type shelves. It allows the technician to verify and test wiring towards the CO and CPE. Easy testing before turn-up dates. With test equipment, a technician can quickly identify opens, shorts, crosses and transmit & receive signals between the shelf and CO or CPE.

Ordering Information:
TB-400 HSDL-HRU Wiring Access Board w/ Pin Jacks

VZ ID #
1100 7917



TB-400B
200/400 Shelf HDSL Test Board (w/ Bantam Jacks)

Application:
The TB-400B (bantam jacks) provides metallic access wiring in 200/400 HDSL type shelves. It allows the technician to verify and test wiring towards the CO and CPE. Easy testing before turn-up dates. With test equipment, a technician can quickly identify opens, shorts, crosses, and transmit & receive signals between the shelf and CO or CPE.

Ordering Information:
TB-400B HSDL-HRU Wiring Access Board w/ Bantam Jacks

VZ ID #
1100 7918

150 Cooper Rd. (F-15)
W. Berlin, NJ 08091

www.tagcords.com

Telephone: (856) 753-8585
Fax : (856) 768-7645

Telecom Assistance Group

AFC

DMAX 1120 Streaker / Test Kit

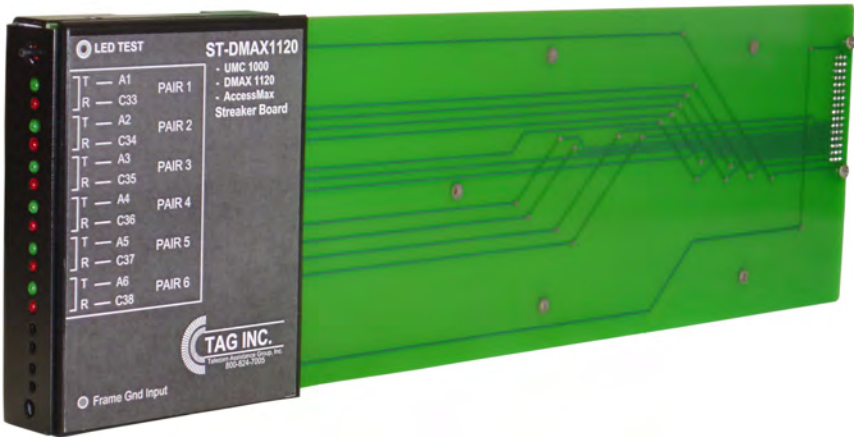

(1) # ST-DMAX1120
AccessMax - DMAX 1120 Streaker Card
(w/ LEDs)

VZ ID #
1103 8363

(Streaker Card)

VZ ID #
1103 8362

(Test Kit)

Application:

The ST-DMAX1120 is utilized by installers to quickly and easily verify wiring from the backplane of the DMAX 1120 to the DSX-1 or cross-connect Frame. Easy access via the test board eliminates slower methods of testing. The "streaker" test determines whether or not the DMAX card slots are properly connected through the interconnect wiring.



(1) # P-2000
Continuity Test Probe w/ LED

VZ ID #
1100 7903



(1) # 600209
Carrying Case
VZ ID # 1100 7886

Approx.
Dimensions:
5" (H) x 16" (L)

Ordering Information:

		VZ ID #
ST-DMAX1120	AccessMax - DMAX 1120 Streaker Card w/ LEDs	1103 8363
D1120KIT-01	DMAX 1120 Streaker / Test Kit includes: (1) ST-DMAX1120, (1) P-2000 & (1) 600209	1103 8362

150 Cooper Rd. (F-15)
W. Berlin, NJ 08091

www.tagcords.com

Telephone: (856) 753-8585
Fax : (856) 768-7645

Telecom Assistance Group

General Bandwidth

G6 Standard Streaker / Test Kit

KIT VZ ID #
1103 7481



(1) # STB-G6TPMDS1
G6 TPM Streaker / Test Board Combo
for 10 DS1 Circuits (w/ LEDs and Bantam Jacks)

Application:

The STB-G6TPMDS1 is a **combination** streaker and test board used in the TPM card slots of the General Bandwidth (G6) system.

As a "**Test Board**" - the STB-G6TPMDS1 provides Bantam Jack access to the 10 DS1 circuits of the TPM card slots. The STB-G6TPMDS1 is ideal for checking wire assignments and pretesting before G6 turn-up dates. With test equipment, a technician can quickly identify opens, shorts, crosses and **transmit and receive T1 signals between the G6 and DSX-1.**

As a "**Streaker**" - the STB-G6TPMDS1 also provides a quick method to "streak", verify wiring via LEDs, from the General Bandwidth backplane to the DSX-1. At the DSX, simply ground the corresponding pins and the STB-G6TPMDS1 will light the LED associated with that connection.



(1) # 400210ARD
Bantam to Alligator Clips DS1 Test Cord - Red, (6')



(1) # 400210RD (VZ ID # 1104 3640)
Bantam to Bantam DS1 Test Cord (Tx) - Red, (6')



(1) # 400210ABK
Bantam to Alligator Clips DS1 Test Cord - Black, (6')



(1) # 400210BK (VZ ID # 1104 3639)
Bantam to Bantam DS1 Test Cord (Rx) - Black, (6')



(1) # P-2000 (VZ ID # 1100 7903)
Protected (-48V) Test Probe w/ LED, (6')



(1) # 600209XL
Carrying Case
(VZ ID # 1103 6239)
(case only)



(1) # 400409 (VZ ID # 700 258 549)
Pin Plug to Alligator, (6')

Approx. Dimensions:
16" (H) x 20" (L)



Ordering Information:

G6TPMKIT-02

G6 Standard Streaker / Test Kit

VZ ID #

1103 7481

includes: (1) STB-G6TPMDS1, (1) 400210RD, (1) 400210BK, (1) 400210ARD, (1) 400210ABK, (1) P-2000, (1) 400409 & (1) 600209XL

150 Cooper Rd. (F-15)
W. Berlin, NJ 08091

www.tagcords.com

Telephone: (856) 753-8585
Fax : (856) 768-7645

Telecom Assistance Group

Lucent (ALU) - Avaya

TB-86B
 "DDM Plus" Office Repeater
 Test Board
 (w/ Bantam Jacks)

VZ ID #
1100 7919



ST-DDM-2
 DDM-2000 Low Speed
 (4 DS1) Streaker Card
 (w/ LEDs)

VZ ID #
1100 7910

Ordering Information:

		<u>VZ ID #</u>
TB-86B	"DDM Plus" Office Repeater Test Board (w/ Bantam Jacks)	1100 7919
ST-86	"DDM Plus" Streaker Kit (not shown) includes: (1) TB-86 ("DDM Plus" Test Board w/ Pin Jacks) & (1) LED-86 (LED/Streaker Adapter)	1100 7908
ST-DDM-2	DDM-2000 Low Speed (4 DS1) Streaker Card (w/ LEDs)	1100 7910
TB-D4	D4/SLC-96 Test Board (not shown) (w/ Pin Jacks)	1100 7920
TB-DDM-2	DDM-2000 Low Speed (4 DS1) Test Board (not shown) (w/ Bantam Jacks)	1100 7890
STB-SERIES 5	Series 5 LED Test Board (not shown)	<u>VZ EAST #</u> 700 249 577
ST-SLC96-D4	D4/SLC-96 LED Test Board (not shown)	700 249 576

150 Cooper Rd. (F-15)
 W. Berlin, NJ 08091

www.tagcords.com

Telephone: (856) 753-8585
 Fax : (856) 768-7645

Telecom Assistance Group

Fujitsu



VZ ID #
1103 8365

ST-F4100ESDS1
Fujitsu Flashwave 4100ES DS1 Streaker Card (w/ LEDs)

Application:
The ST-F4100ESDS1 provides a quick method to - verify wiring via LEDs ("streak") from the Fujitsu FLASHWAVE 4100ES DS1 slots to the DSX-1. The ST-F4100ESDS1 verifies wiring continuity of 28 DS1 circuits. At the DSX-1, using bantam to alligator clips, simply ground the corresponding pins and the ST-F4100ESDS1 will light the LED associated with that connection.



VZ ID #
1103 8367

TB-F4100ESDS3
Fujitsu Flashwave 4100ES DS3 Test Board (w/ 440A Jacks)

Application:
The TB-F4100ESDS3 provides metallic access to the three (3) DS3 circuits via 440A jacks from the FLASHWAVE 4100ES DS3 card slot to the DSX-3/4.



VZ ID #
1125 7849

TB-F4100ESDS3-8
Fujitsu Flashwave 4100ES DS3 Test Board (w/ 440A Jacks)

Application:
The TB-F4100ESDS3-8 provides metallic access to the eight (8) DS3 circuits via 440A jacks from the FLASHWAVE 4100ES DS3 card slot to the DSX-3/4.



VZ ID #
1103 8366

TB-F4100ESDS1
Fujitsu Flashwave 4100ES DS1 Test Board (w/ Bantam Jacks)

Application:
The TB-F4100ESDS1 provides metallic access to 28 DS1 circuits via bantam jacks to perform continuity and signal acceptance testing from the Fujitsu FLASHWAVE 4100ES DS1 slots to the DSX-1. Using a T1 test set, the tester can transmit and receive T1 signals to verify cable acceptance and continuity.

VZ ID #
1103 8368

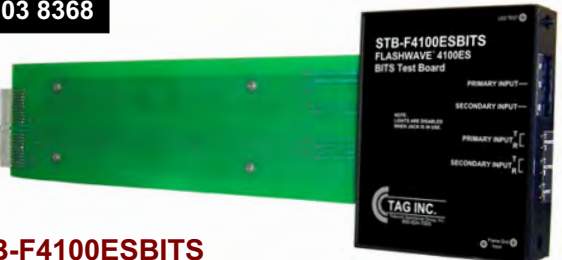

STB-F4100ESBITS
Fujitsu Flashwave 4100ES BITS Streaker/Test Board (w/ LEDs and Bantam Jacks)

Application:
The STB-F4100ESBITS provides both continuity testing and jack access for signal acceptance testing from the BITS card slot to the cross-connect wiring points.

150 Cooper Rd. (F-15)
W. Berlin, NJ 08091

www.tagcords.com

Telephone: (856) 753-8585
Fax : (856) 768-7645

Telecom Assistance Group

Adtran

"Total Access 5000"



ST-T5K-DS1
Adtran TA5000 DS1 Streaker Card
(Can be used for both 32 port DS1 & 32 port DS1 Voice Gateway)
(w/ 128 LEDs)

Application:
The ST-T5K-DS1 provides a quick method to "streak", verify wiring via LEDs, from the backplane of the Adtran TA5000 (1187400L1) to the DSX-1. At the DSX-1 simply ground the corresponding pins and the ST-T5K-DS1 will light the LED associated with that connection.

Ordering Information:

ST-T5K-DS1 **Adtran TA5000 DS1 Streaker Card**
460230 **Carrying Case (9" (H) x 16" (L))**

VZ ID #
1128 4266
1101 5232

ST-T5K-SPLTRA
Adtran TA5000 ADSL Splitter Streaker Card
32 Port (w/ 128 LEDs)

Application:
The ST-T5K-SPLTRA provides a quick method to "streak", verify wiring via LEDs, from the backplane of the Adtran TA5000 (1187450L1, 1187450G1) to the Frame. At the Frame simply ground the corresponding pins and the ST-T5K-SPLTRA will light the LED associated with that connection.



Ordering Information:

KIT-T5K-SPLTRA **Adtran TA5000 ADSL Splitter Streaker Kit**
includes: (1) ST-T5K-SPLTRA, Streaker Card
(1) 400409, Pin Plug to Alligator, (6') (VZ ID # 700 258 549)
(1) P-2000, Protected (-48V) Test Probe w/ LED, (6')
(1) 460230, Carrying Case (VZ ID # 1101 5232)

KIT VZ ID #
1110 0581

ST-T5K-SPLTRA **Adtran TA5000 ADSL Splitter Streaker Card** **1110 0938**
P-2000 **Protected (-48V) Test Probe w/ LED, (6')** **1100 7903**
460230 **Carrying Case (9" (H) x 16" (L))** **1101 5232**

150 Cooper Rd. (F-15)
W. Berlin, NJ 08091

www.tagcords.com

Telephone: (856) 753-8585
Fax : (856) 768-7645

Telecom Assistance Group

DS1/DS3 Cord Kit

DS1 (T1 Cords)

Bantam Jack on Test Set

- (1) Bantam to Bantam, (8') - Red # **400210RD-08**
- (1) Bantam to Bantam, (8') - Black # **400210BK-08**



- (1) Bantam to Alligator Clips, (8') - Red # **400210ARD-08**
- (1) Bantam to Alligator Clips, (8') - Black # **400210ABK-08**

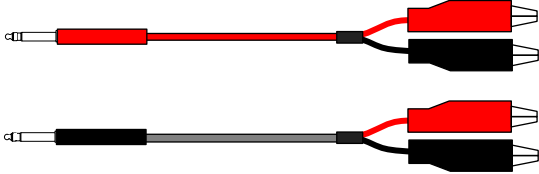

- (1) Bantam to Protector, (8') - Red # **400210SRD-08**
- (1) Bantam to Protector, (8') - Black # **400210SBK-08**

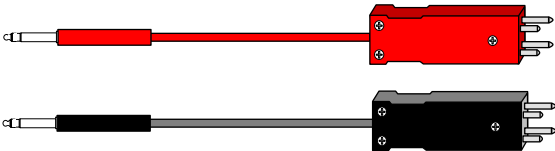

- (1) Bantam "Y" to RJ48 -T1, (8') # **400248**

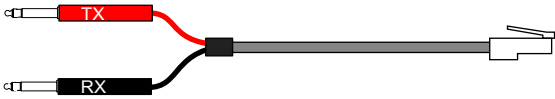

- (1) Bantam to 310 Adapter - Red # **400239RD**
- (1) Bantam to 310 Adapter - Black # **400239BK**

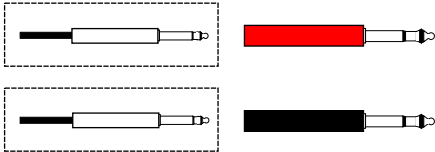

DS3 (T3 Cords)

440A Jack (Weco560A) on Test Set

- (1) 440A to 440A, (8') - Red # **400440ARD-08**
- (1) 440A to 440A, (8') - Black # **400440ABK-08**



- (1) 440A to 358A (8') - Red # **440358ARD-08**
- (1) 440A to 358A (8') - Black # **440358ABK-08**



- (1) 440A to BNC (8') - Red # **400440BRD-08**
- (1) 440A to BNC (8') - Black # **400440BBK-08**



(1) 8 Pocket Carrying Case # **TCC-001P**

Ordering Information:

2209KIT DS1/DS3 KIT

KIT VZ ID #
1100 7868

150 Cooper Rd. (F-15)
W. Berlin, NJ 08091

www.tagcords.com

Telecom Assistance Group

Telephone: (856) 753-8585
Fax : (856) 768-7645

DSX-3 Test Cord Kit

BA-DSX3



**INCLUDES
CARRYING
CASE**

**Cord Kit
for
DSX-3/4 Testing**

(1) # TCC-001P
8 Pouch Carrying Case

(1) # 400440ARD-08
440A to 440A, (8') - Red
VZ ID # 1100 7951



(1) # 400440ABK-08
440A to 440A, (8') - Black
VZ ID # 1100 7950



(1) # 440358ARD-08
440A to 358, (8') - Red
VZ ID # 1100 7955



(1) # 440358ABK-08
440A to 358, (8') - Black
VZ ID # 1100 7954



(1) # 400440BRD-08
440A to BNC, (8') - Red
VZ ID # 1100 7953



(1) # 400440BBK-08
440A to BNC, (8') - Black
VZ ID # 1100 7952



(1) # 400704
Surge Suppressor - Outlet Power Strip

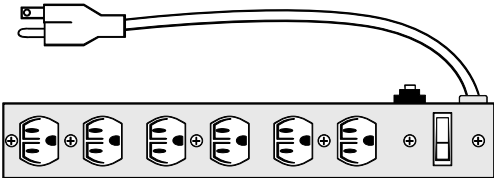

Ordering Information:

BA-DSX3

DSX-3 Test Cord Kit

includes: (1) 400440ARD-08, (1) 400440ABK-08,
(1) 400440BRD-08, (1) 400440BBK-08,
(1) 440358ARD-08, (1) 440358ABK-08,
(1) 400704 & (1) TCC-001P -Carrying Case

**VZ ID #
1100 7893**

150 Cooper Rd. (F-15)
W. Berlin, NJ 08091

www.tagcords.com

Telephone: (856) 753-8585
Fax : (856) 768-7645

Telecom Assistance Group

T1/T3 VeEX Test Cord Kit

KIT-VXT1T3



T1/T3 Test Cord Kit for use with VeEX MTX150-10G Test Set

-Individual items can also be ordered-

Provides a carrying case with all the cords that a "Tech" needs in the field

8 Pouch Carrying Case # TCC-001P

- (1) Bantam to Bantam, (8') - Red # 400210RD-08
- (1) Bantam to Bantam, (8') - Black # 400210BK-08



- (1) 358A to BNC, (8') - Red # 400358BRD-08
- (1) 358A to BNC, (8') - Black # 400358BBK-08



- (1) Bantam to Alligators, (8') - Red # 400210ARD-08
- (1) Bantam to Alligators, (8') - Black # 400210ABK-08

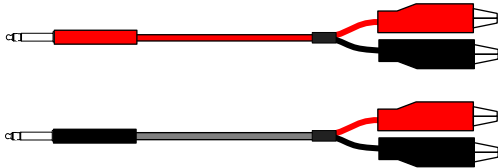

- (1) 440A to BNC (8') - Red # 400440BRD-08
- (1) 440A to BNC (8') - Black # 400440BBK-08



- (1) Bantam to Protector, (8') - Red # 400210SRD-08
- (1) Bantam to Protector, (8') - Black # 400210SBK-08

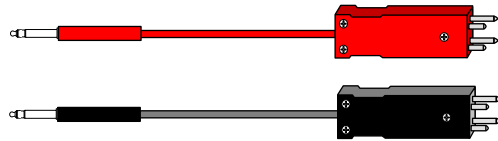

- (1) RJ45 to RJ45, 1Gb Ethernet Cable (10') # 400445E-10

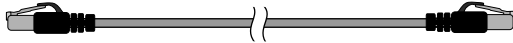

- (1) Bantam "Y" to RJ48 -T1, (8') # 400248Y



- (1) Bantam to 310 Adapter- Red # 400239RD
- (1) Bantam to 310 Adapter- Black # 400239BK

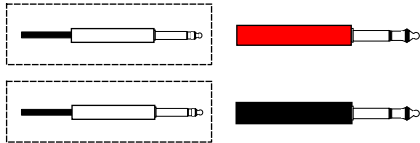

Ordering Information:

KIT-VXT1T3

T1/T3 VeEX Test Cord Kit

VZ ID #
7500 3145

150 Cooper Rd. (F-15)
W. Berlin, NJ 08091

www.tagcords.com

Telephone: (856) 753-8585
Fax : (856) 768-7645

Telecom Assistance Group

Protector to MLT Test Box

400301MLT

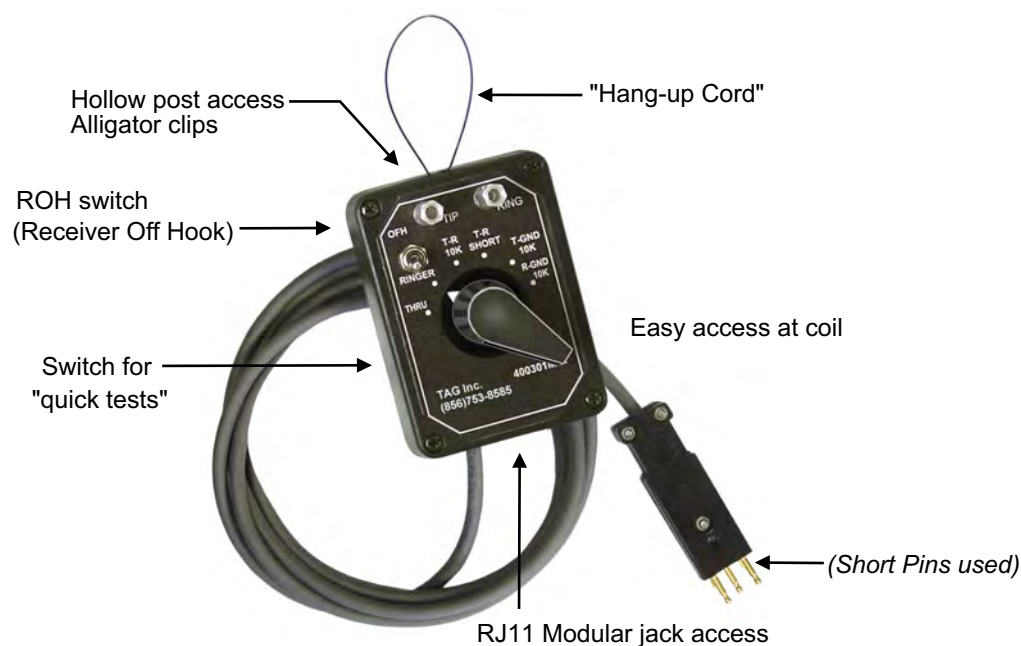

TAG's MLT Load/Test Box (400301MLT) provides a convenient and easy means to **Test** with **MLT** on **New Installs** and **Calibrate "Loop" Resistance**.

Simply plug the MLT Load/Test Box on the circuit to test with MLT. Establish communication with a MLT tester to verify results.

Note: TAG offers a "Hands Free" Telephone Set (WT-1K) for added convenience. A sturdy switch on the MLT Load/Test Box allows selecting the following tests:

- **Tip to Ring Short**
 - **Tip to Ring Load (10K)**
 - **Tip to Ground (10K)**
 - **Ring to Ground (10K)**
 - **Ringer Test Load (>.75A)**
 - **ROH (Receiver off Hook)**
- Switch w/ Off Hook Impedance**

The MLT Load/Test Box plugs to various interface points for ease of testing with MLT. The 400301MLT can be equipped with "coil access" at the RT, RJ11 access at the NID or alligator clips for general purpose.

Ordering Information:

400301MLT

Protector to MLT Test Box

VZ ID #

1100 7882

150 Cooper Rd. (F-15)
W. Berlin, NJ 08091

www.tagcords.com

Telephone: (856) 753-8585
Fax : (856) 768-7645

Telecom Assistance Group

Remote Network Cable Tester w/ Tone Generator

CAT-107G

Simplify Network Cable Testing !!

Cable Test Features:

- Displays:**
- Short
 - Reversed
 - Miswired
 - Split Pairs

Tone Generator* Features:

- Verification of Shield Integrity
- Puts Tracer Tone on Cable

* Tone Generator function requires customer supplied Cable Tracing Probe

Additional Features:

- Specially designed Remote Unit that enables one person to test installed cables
- Easy to read Fault Display and high speed testing
- Debug mode for detailed fault identification results
- Auto Sleep Mode and Power Off Switch to decrease power consumption
- Low Battery Indicator
- Uses (4) four AAA batteries

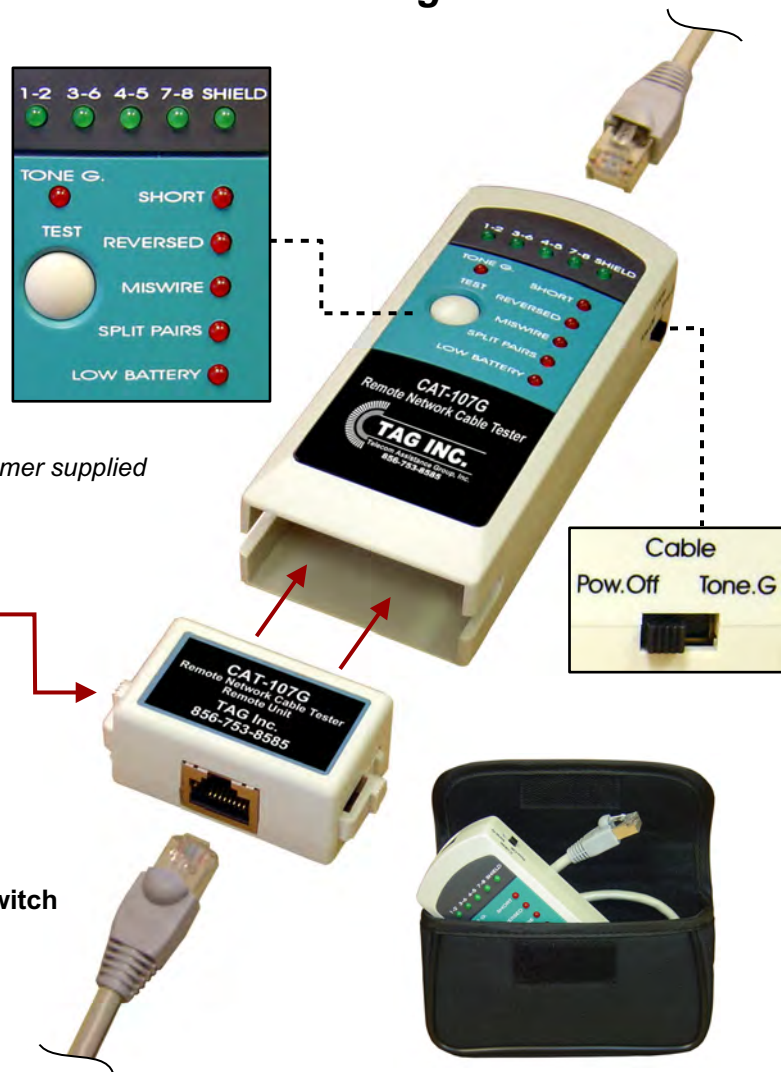

Includes: Soft Vinyl Carrying Pouch & Remote Terminating Cable

Application:

The CAT-107G is a small hand-held cable tester, which enables network professionals to quickly and easily verify the integrity of ethernet twisted pair cables for open pairs, shorted pairs, reversed pairs, crossed pairs and split pairs. Push the TEST button and the CAT-107G will automatically scan for any existing faults in your cable. The specially designed remote terminator is provided for one-person testing of installed cables. The tone generator function can be used to send a signal through installed cables which can be traced with most cable tracers on the market.

Ordering Information:

CAT-107G Remote Network Cable Tester w/ Tone Generator

includes: (1) Carrying Pouch, (1) Remote Terminating Cable & (4) AAA Batteries

VZ ID #

1132 2736

150 Cooper Rd. (F-15)
W. Berlin, NJ 08091

www.tagcords.com

Telephone: (856) 753-8585

Fax : (856) 768-7645

Telecom Assistance Group

USB-C to DB9 Pin (male) - (Android & Laptop Compatible)

400721USBC-A

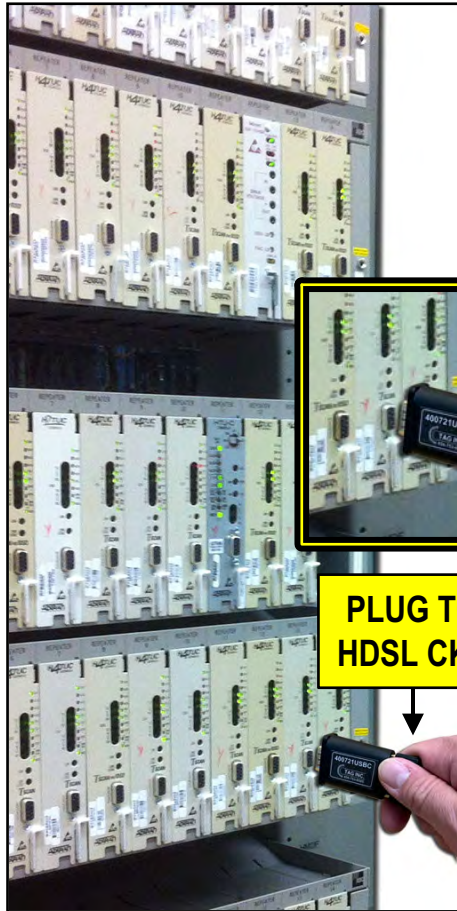

**PLUG TO
HDSL CKT**



Use VZ Term Assist App to test at Pair Gain (HDSL)

**PLUG TO USB-C
PORT ANDROID PHONE**

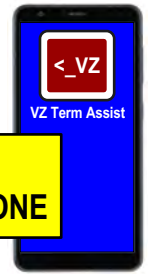

OR



PLUG TO USB-C PORT ON LAPTOP

Ordering Information:

400721USBC-A

USB-C to DB9 Pin (male) - (Android & Laptop Compatible), (3')

VZ ID #

7500 5061

150 Cooper Rd. (F-15)
W. Berlin, NJ 08091

www.tagcords.com

Telecom Assistance Group

Telephone: (856) 753-8585
Fax : (856) 768-7645

DB9M / RS232 to USB Adapter Cable

Need access to a Serial Port on your Laptop?

TAG's Adapter Cable will convert your Laptop's USB Port into a Serial Port!

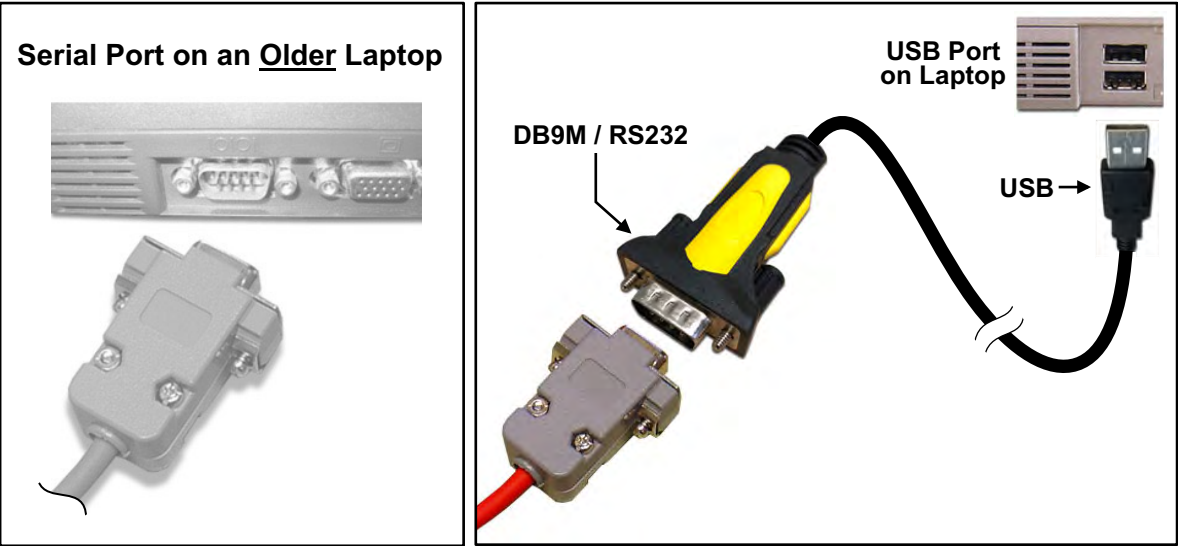

System Requirements:

- Supports Windows® 2000 / XP / Server 2008 / Vista / 7 / 8 / 10
- Available USB Port

Application:

Plug the USB connector into your computer and the serial connector into your serial device to exchange files, data and more.



Ordering Information:		VZ ID #
400721USB* <small>* (NEW Windows 10 Version)</small>	DB9M/RS232 to USB Adapter Cable <small>Supports Windows® 2000 / XP / Server 2008 / Vista / 7 / 8 / 10</small>	1135 9653
T-USBFD	4GB USB Flash Drive	1128 5359

150 Cooper Rd. (F-15)
W. Berlin, NJ 08091

www.tagcords.com

Telephone: (856) 753-8585
Fax : (856) 768-7645

Telecom Assistance Group

Laptop Cord Kit

KIT-LAPVZKO

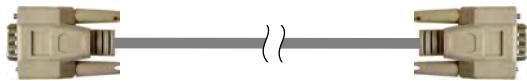

(1) # 400720MM
DB9M to DB9M, (10')
VZ ID # 1128 5350

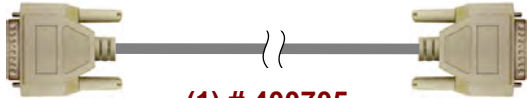

(1) # 400705
DB25M to DB25M, (6')
VZ ID # 8702 8149

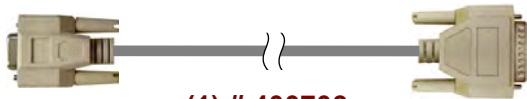

(1) # 400703
DB9F to DB25M, (6')
VZ ID # 8702 8151

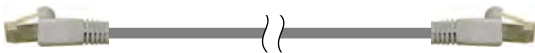

(1) # 400448-06
RJ48 to RJ48 Ethernet Cable, (6')
VZ ID # 1128 5351

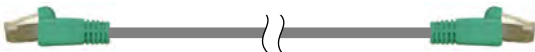

(1) # 400448XP
RJ48 to RJ48
Ethernet Crossover Cable, (10')
VZ ID # 1128 5352



(1) # 600209
Carrying Case
VZ ID # 1100 7886 Approx.
Dimensions:
5" (H) x 16" (L)



(1) # 400700
DB25F Gender Changer
VZ ID # 8722 5617



(1) # 400700N
DB25F Gender Changer (NULL)
VZ ID # 8726 2699



(1) # 400709S
DB9F Gender Changer
VZ ID # 8722 6870



(1) # 400709FN
DB9F Gender Changer (NULL)
VZ ID # 8722 6868



(1) # RJ48-C
RJ48 Coupler
VZ ID # 1128 5348



(1) # 400721USB
DB9M/RS232 to USB Adapter Cable
(includes driver software)
VZ ID # 1135 9653

Ordering Information:

KIT-LAPVZKO Laptop Cord Kit

includes: (1) 400720MM, (1) 400705, (1) 400703, (1) 400448-06,
(1) 400448XP, (1) 400700, (1) 400700N, (1) 400709S,
(1) 400709FN, (1) RJ48-C, (1) 400721USB & (1) 600209

VZ ID # (KIT)
1128 5349

150 Cooper Rd. (F-15)
W. Berlin, NJ 08091

www.tagcords.com

Telephone: (856) 753-8585
Fax : (856) 768-7645

Telecom Assistance Group

Verizon Approved - Fiber Optic Test Cord Kit 2

FOTC-KIT2

Fiber Optic Test Cords Included in Kit:

Carrying Case included with Kit



(2) 430773UAM-03
SC/APC to LC/UPC, Singlemode Simplex, 3.0mm yellow, Test Cord, 3 Meters



(2) 430766AAM-03
SC/APC to SC/APC, Singlemode Simplex, 3.0mm yellow, Test Cord, 3 Meters



(2) 430773AAM-03
SC/APC to LC/APC, Singlemode Simplex, 3.0mm yellow, Test Cord, 3 Meters



(2) 430766AM-03
SC/APC to SC/UPC, Singlemode Simplex, 3.0mm yellow, Test Cord, 3 Meters



(2) 430779AM-03
SC/APC to ST/UPC, Singlemode Simplex, 3.0mm yellow, Test Cord, 3 Meters



(2) 430770AM-03
SC/APC to FC/UPC, Singlemode Simplex, 3.0mm yellow, Test Cord, 3 Meters



(2) 430778AM-03
SC/APC to D4/UPC, Singlemode Simplex, 3.0mm yellow, Test Cord, 3 Meters

Fiber Optic Adapters Included in Kit:

- | | | | |
|--|---|--|---|
| (1) 400766C
SC to SC
Simplex
UPC Coupler | (1) 400766AC
SC to SC
Simplex
APC Coupler | (1) 400781C
LC to LC
Simplex
UPC Coupler | (1) 400781AC
LC to LC
Simplex
APC Coupler |
| | | | |
| (1) 400758C
ST to ST
Simplex
UPC Coupler | | (1) 400752C
FC to FC
Simplex
UPC Coupler | |
| | | (1) 400756C
D4 to D4
Simplex
UPC Coupler | |

Ordering Information:

FOTC-KIT2
Fiber Optic Test Cord Kit 2

includes: (14) Test Cords, (7) Adapters & (1) Carrying Case (not shown)

VZ ID #
1136 7387

150 Cooper Rd. (F-15)
W. Berlin, NJ 08091

www.tagcords.com
Telecom Assistance Group

Telephone: (856) 753-8585
Fax: (856) 768-7645

TAG Fiber Streakers & Test Cords

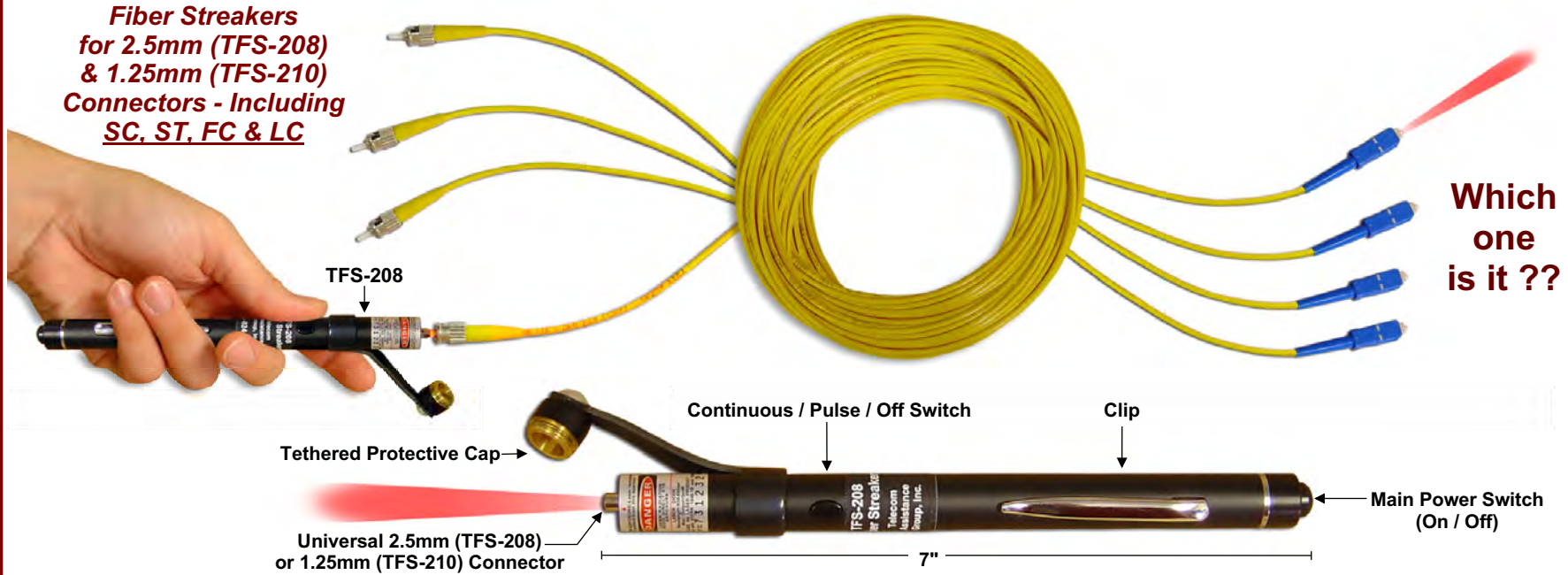

**Fiber Streakers
for 2.5mm (TFS-208)
& 1.25mm (TFS-210)
Connectors - Including
SC, ST, FC & LC**

**Which
one
is it ??**

- ▶ Available with 2.5mm (TFS-208) & 1.25mm (TFS-210) receptacles for singlemode and multimode fibers
- ▶ The TFS-208 accepts any connector with a 2.5mm ferrule including SC, ST & FC connectors
- ▶ The TFS-210 accepts any connector with a 1.25mm ferrule including LC connectors
- ▶ Continuous and pulsed operation modes ▶ High visibility up to 3 km ▶ 650 nm laser output

Ordering Information:

		<u>VZ ID #</u>
TFS-208	Tag Fiber Streaker (2.5mm) - includes: (1) carrying case & (2) AAA batteries	1105 1182
TFS-210	Tag Fiber Streaker (1.25mm) - includes: (1) carrying case & (2) AAA batteries	1105 2921
<hr style="border-top: 1px dashed black;"/>		
400766DM-05	SC to SC, Singlemode Duplex, 2.0mm yellow, UPC, (5 meters) - (not shown)	1108 9995
400766DM-10	SC to SC, Singlemode Duplex, 2.0mm yellow, UPC, (10 meters) - (not shown)	1108 9994
400771DM-05	SC to ST, Singlemode Duplex, 2.0mm yellow, UPC, (5 meters) - (not shown)	1108 9993
400771DM-10	SC to ST, Singlemode Duplex, 2.0mm yellow, UPC, (10 meters) - (not shown)	1108 9992

150 Cooper Rd. (F-15)
W. Berlin, NJ 08091

www.tagcords.com
Telecom Assistance Group

Telephone: (856) 753-8585
Fax: (856) 768-7645

LEN Jack Cords

PN # F44-327RJ11
Dual Plug (327) w/ RJ11 Jack

VZ ID #
1106 7821

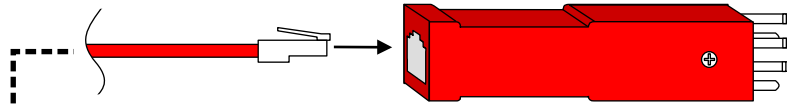
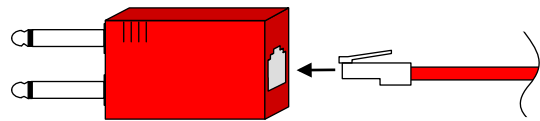

PN # F44-463RJ11
Protector (463)
w/ RJ11 Jack

VZ ID #
1106 7885

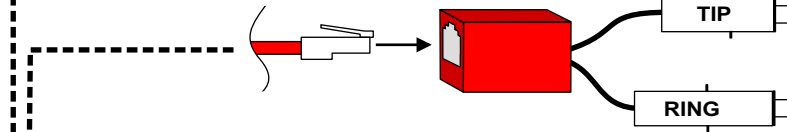

PN # F44-412RJ11
412 w/ RJ11 Jack

VZ ID #
1106 7820

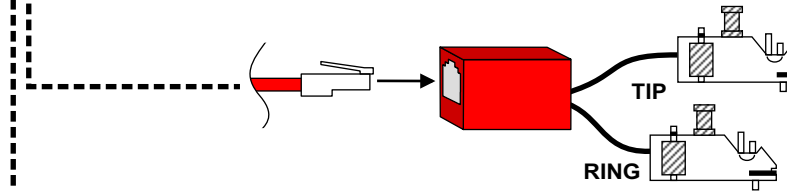

PN # F44-252RJ11
252 w/ RJ11 Jack

VZ ID #
1106 7819

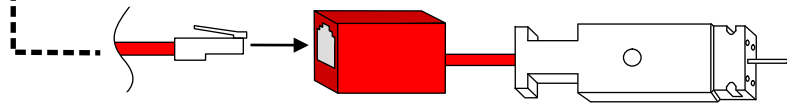

PN # F44-CJPRJ11
Porta w/ RJ11 Jack

VZ ID #
1106 7818

150 Cooper Rd. (F-15)
W. Berlin, NJ 08091

www.tagcords.com
Telecom Assistance Group

Telephone: (856) 753-8585
Fax: (856) 768-7645

Universal Frame "Frogging Solution"

"Frogger" Protector Test Cords

1. Insert "Good" (green) plug into known good line.
2. Insert "Bad" (red) plug into bad line for temporary restoration.

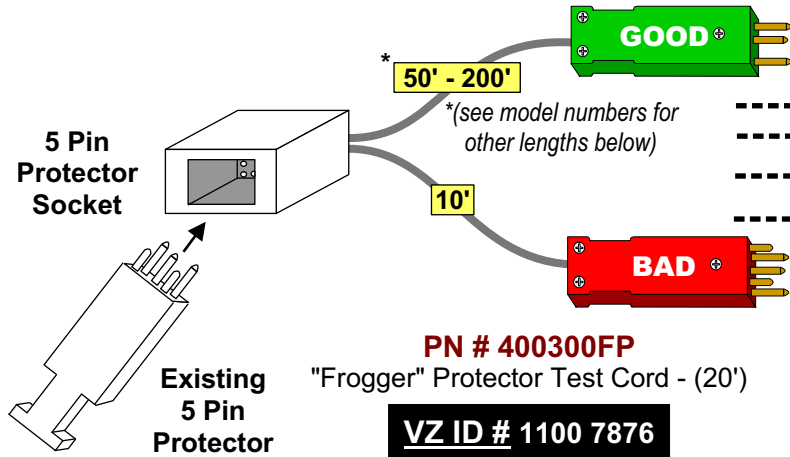

Ordering Information:

400300FP-50	"Frogger" Protector Test Cord - (50')
400300FP-75	"Frogger" Protector Test Cord - (75')
400300FP-100	"Frogger" Protector Test Cord - (100')
400300FP-150	"Frogger" Protector Test Cord - (150')
400300FP-200	"Frogger" Protector Test Cord - (200')

"Frogger" Cord Extender

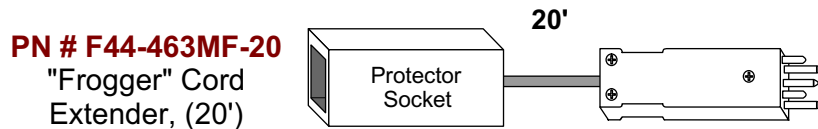

"Frogger" Universal Adapters

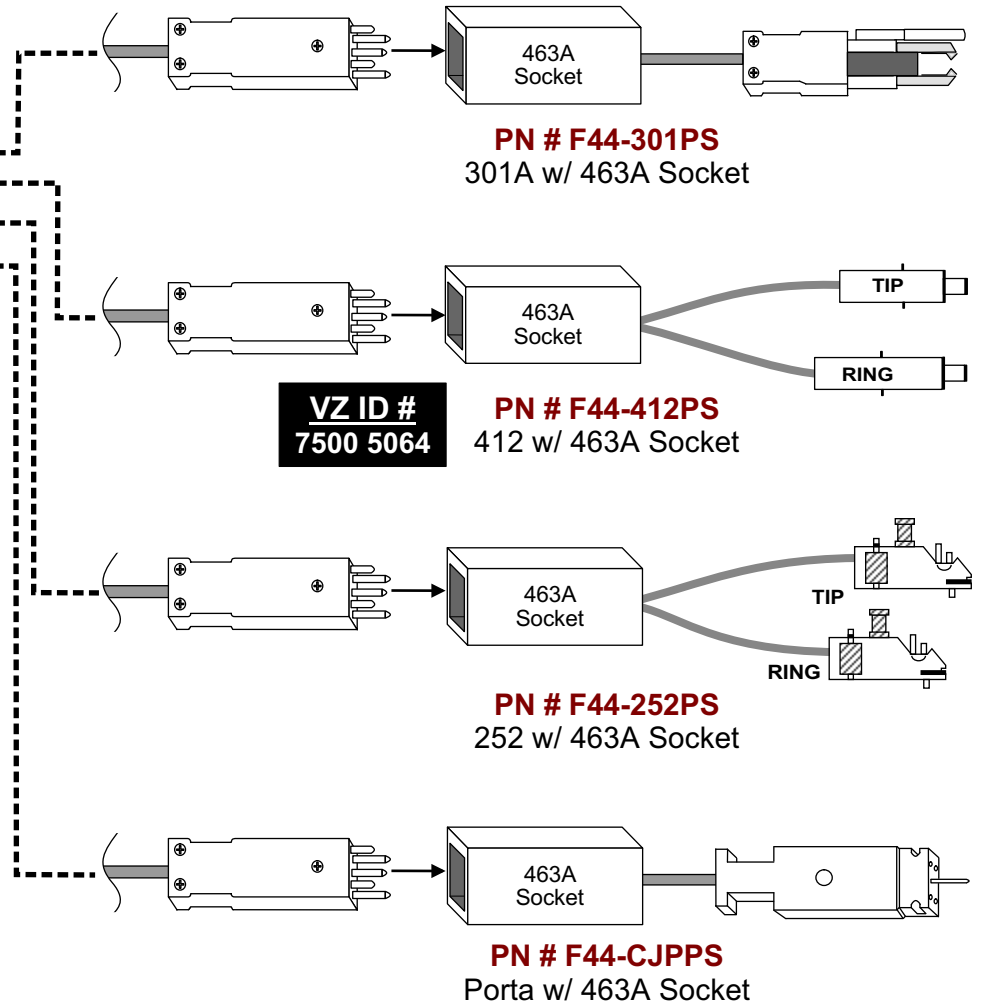

150 Cooper Rd. (F-15)
W. Berlin, NJ 08091

www.tagcords.com

Telecom Assistance Group







Telephone: (856) 753-8585
Fax: (856) 768-7645

SS7 Audit Kit

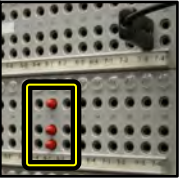
SS7-KIT

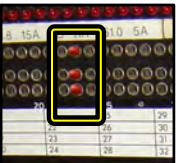
KIT VZ Material ID #
1105 3270

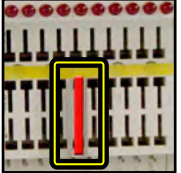

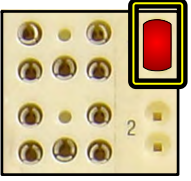
Dummy Plugs

QTY / PN # / DESC.	(not to scale)	
(20) 310DP 310 Dummy Plug	 VZ ID # 700 262 684 (QTY of 1)	
(20) 210DP Bantam Dummy Plug	 VZ ID # 1105 5520 (QTY of 1)	
(8) 800DP 800 DSX Dummy Plug	 VZ ID # 700 264 167 (QTY of 1)	
(10) 453ADP 453A Dummy Plug		

- Plugs into vacant 310 (PN # 310DP), bantam (PN # 210DP), 800 DSX (PN # 800DP) or 453A (PN # 453ADP) jacks
- Used to prevent accidental insertion / disruption of the circuit
- Identifies special circuits (i.e. SS7 circuits)





Protective Caps

Carrying Case Included

QTY / PN #	Description	(not to scale)
(50) SS7-2P	SS7 2 Pin Cap (1/2)	
(50) SS7-3P	SS7 3 Pin Cap (5/8)	
(24) SS7-6P	SS7 6 Pin Cap (1 3/8)	

- Placed over wire wrap terminals at MDF Frames
- Identifies special circuits (i.e. SS7 circuits)

Labels & Tags

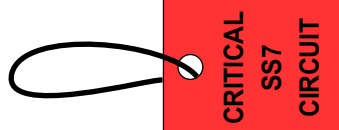
PN #	Description / QTY	(approx. size)
SS7-LB1	SS7 Labels, (SM) VZ ID #: 1105 6750 (QTY of 50)	
SS7-LB2	SS7 Labels, Rectangle (SM) VZ ID #: 1110 1991 (QTY of 50)	
SS7-LB3	SS7 Labels, Rectangle (LG) VZ ID #: 1110 1992 (QTY of 25)	
SS7-LBL3B	SS7 Labels, Rectangle (XLG) VZ ID #: 1126 2947 (QTY of 25)	
SS7-TAG	SS7 Threaded Tag VZ ID #: 1128 0030 (QTY of 50)	

150 Cooper Rd. (F-15)
W. Berlin, NJ 08091

www.tagcords.com

Telecom Assistance Group

Telephone: (856) 753-8585

Fax: (856) 768-7645

Portable "R" - HDSL Test Unit Kit

RHDSL-BST01

RHDSL-BST01
Portable "R" -
HDSL Test Unit Kit
VZ ID # (KIT)
1137 1496



(1) # 600509
 Carrying Case

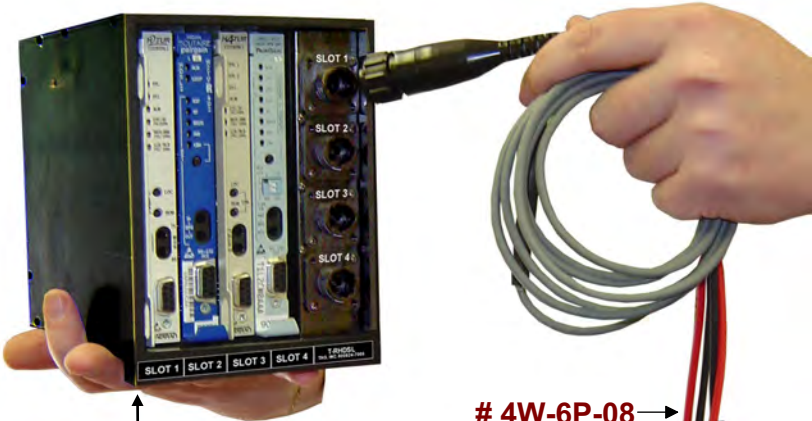

(cards not included)

4W-6P-08 →

- ▶ **4 Slots for 200/400 Mech. HDSL "R" Cards**
- ▶ **Rugged Connectors**
- ▶ **Various Test Cords**

(1) # 4W-6P-08
 Female Lock Plug to
 (4) 6P Alligator Clips, (8')

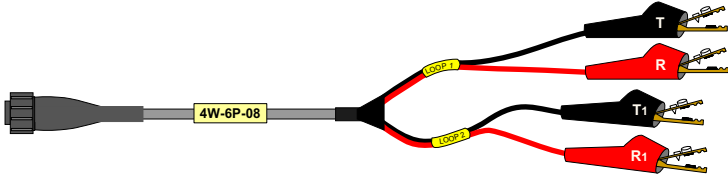

(1) # 4W-463Y-08
 Female Lock Plug to
 5 Pin "Y" Protector, (8')

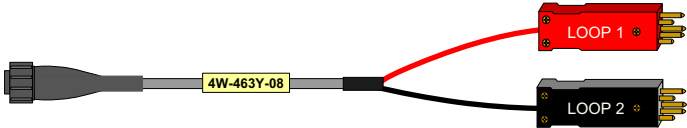

Ordering Information:

RHDSL-BST01	Portable "R" - HDSL Test Unit Kit (w/ 6P Alligators) includes: (1) T-RHDSL, (1) 4W-6P-08, (1) 4W-463Y-08 & (1) 600509	VZ ID # 1137 1496
T-RHDSL	Portable "R" - HDSL Test Unit (requires test cords)	1104 3643
4W-463Y-08	Female Lock Plug to 5 Pin "Y" Protector, (8')	1104 3645
600509	Carrying Case	1104 3641
4W-6P-16	Female Lock Plug to (4) 6P Alligator Clips, (16')	1131 4133
4W-A-08	Female Lock Plug to (4) Std Alligator Clips, (8')	1104 3644
RHDSL-KIT4	Portable "R" - HDSL Test Unit Kit (w/ Standard Alligators) includes: (1) T-RHDSL, (1) 4W-A-08, (1) 4W-463Y-08 & (1) 600509	1104 3646

150 Cooper Rd. (F-15)
 W. Berlin, NJ 08091

www.tagcords.com

Telephone: (856) 753-8585
 Fax : (856) 768-7645

Telecom Assistance Group

Portable "C" - HDSL Powering Test Unit Kit

PHTUC-KIT01VZ



(card not included)

PHTUC-KIT01VZ

Portable "C" - HDSL Powering Test Unit Kit

VZ ID # (KIT) 1104 3635

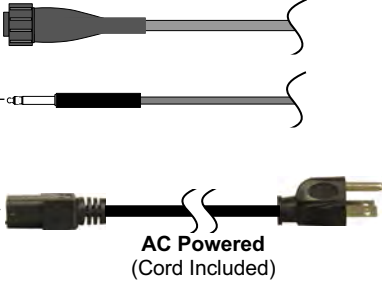

AC Powered (Cord Included)



(1) PHTUC-01 Portable "C" - HDSL Powering Test Unit w/ AC Power Cord

VZ ID # 1104 3636

(1) 4C-6P-08 Male Lock Plug to (4) 6P Alligator Clips, (8')

VZ ID # 1104 3637

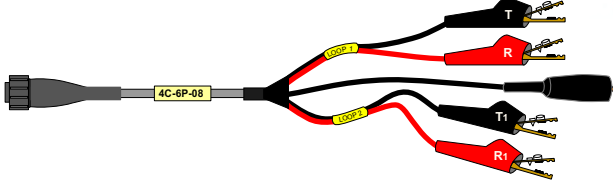

(1) 600510 Carrying Case

VZ ID # 1105 4904

Ordering Information:

PHTUC-KIT01VZ

Portable "C" - HDSL Powering Test Unit Kit

Includes: (1) PHTUC-01, (1) 4C-6P-08 & (1) 600510- Carrying Case

VZ ID # (KIT) 1104 3635

Additional Accessories Available

4C-463Y-08 Male Lock Plug to 5 Pin "Y" Protector, (8')

VZ ID # 1104 3638

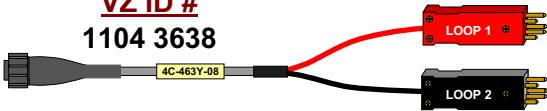

400210BK Bantam to Bantam - Black, (6')

VZ ID # 1104 3639

4C-PORTY-08 Male Lock Plug to Porta "Y", (8')

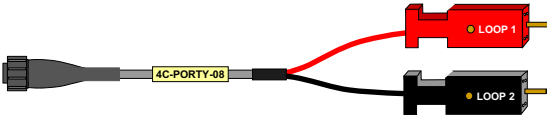

400210RD Bantam to Bantam - Red, (6')

VZ ID # 1104 3640

4C-412Y-08 Male Lock Plug to 412 "Y", (8')

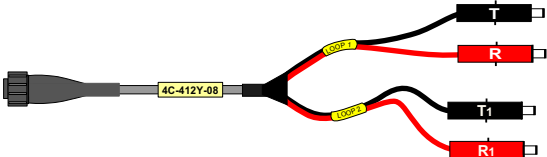

150 Cooper Rd. (F-15) W. Berlin, NJ 08091

www.tagcords.com

Telephone: (856) 753-8585 Fax : (856) 768-7645

Telecom Assistance Group

GTD5 Terminal Replacements - Dual Session

Model:

TT-DCAG5

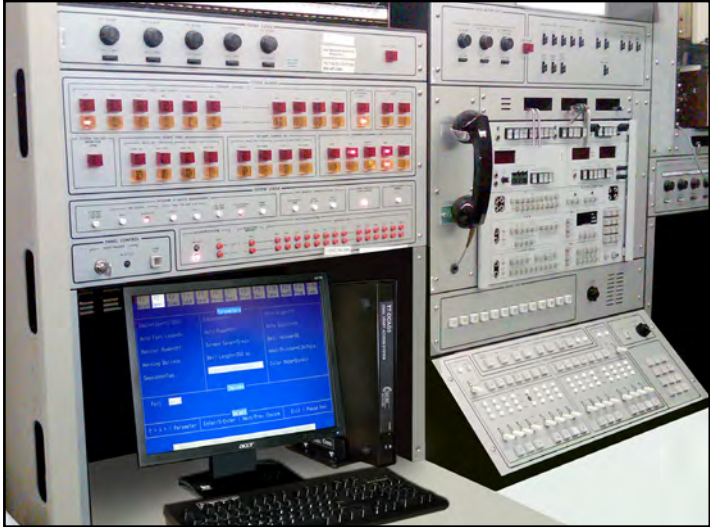

Includes:

- (1) 17" Flat Screen Monitor
- (1) Dumb Terminal Controller
- (1) TT-MTG5
(Vertical Mounting Kit)
- (1) Keyboard
- (1) Quick Guide
- (2) 400701,
(DB25M Gender Changer)



SPECIFICATIONS

- VT-100 COMPATIBLE
- DUAL RS-232 INPUTS
- PRINTER OUTPUT
- LOW POWER

Printer Port Type:



↑
Parallel *

* If a Serial Port is needed, please order the KIT, # TT-DCAG5-KIT1 which includes a Parallel to Serial Adapter # TT-PSA.

TT-DCAG5	Dual Craft Access System - GTD5 includes: (1) 17" Flat Screen Monitor, (1) Keyboard, (1) Dual Session Dumb Terminal Controller, (1) Quick Guide (1) # TT-MTG5 (Vertical Mounting Kit (VZ ID # 1118 4320)) & (2) # 400701 (DB25M Gender Changer)	VZ ID # 1118 4322
TT-DCAG5-KIT1	Dual Craft Access System - GTD5 Kit includes: (1) 17" Flat Screen Monitor, (1) Keyboard, (1) Dual Session Dumb Terminal Controller, (1) Quick Guide, (1) # TT-MTG5 (Vertical Mounting Kit (VZ ID # 1118 4320)) (2) # 400701 (DB25M Gender Changer) & (1) # TT-PSA** (Parallel to Serial Printer Adapter w/ AC Power Pack) **not shown	KIT VZ ID # 1118 4321
TT-DCA5-PP	Replacement Power Pack for GTD5 Terminal, 5VDC (not shown)	1136 2015

150 Cooper Rd. (F-15)
W. Berlin, NJ 08091

www.tagcords.com

Telephone: (856) 753-8585
Fax : (856) 768-7645

Telecom Assistance Group

Siemens EWSD OMT* Terminal Replacements



Model:
TT-DCAOMT

(1) 17" Flat Screen Monitor

(1) EWSD® OMT® Controller

(1) Keyboard

(1) TT-MOUSEPS
(Optical Mouse)

(1) 400700
(DB25F Gender Changer)

Back of Terminal Controller:



Ordering Information:

TT-DCAOMT	Siemens EWSD OMT Craft Access System includes: (1) 17" Flat Screen Monitor, (1) Keyboard, (1) EWSD OMT Controller, (1) # TT-MOUSEPS & (1) # 400700	VZ ID # 1129 0638
TT-MOUSEPS	Optical Mouse Replacement	1128 4343
TT-DCA5-PP	Replacement Power Pack for EWSD Terminal, 5VDC	1136 2015

150 Cooper Rd. (F-15)
W. Berlin, NJ 08091

www.tagcords.com

Telephone: (856) 753-8585
Fax : (856) 768-7645

Telecom Assistance Group

DSC CS1 (CS1L) Terminal Replacements - Dual Session



Model:

TT-DCACS1

(1) 17" Flat Screen Monitor

(1) Dumb Terminal Controller

(1) Keyboard

(1) Quick Guide

(2) 400701
(DB25M Gender Changer)

Printer Port Type:

- SPECIFICATIONS**
- VT-100 COMPATIBLE
 - DUAL RS-232 INPUTS
 - PRINTER OUTPUT
 - LOW POWER



↑
Parallel *
** if a Serial Port is needed,
 please order # TT-PSA, VZ ID # 1118 2239*

Ordering Information:

TT-DCACS1 Dual Craft Access System - DSC CS1 (CS1L)
 includes: (1) 17" Flat Screen Monitor, (1) Keyboard,
 (1) Dumb Terminal Controller, (1) Quick Guide &
 (2) # 400701 - DB25M Gender Changer

VZ ID #
1131 5066

TT-DCA5-PP Replacement Power Pack for Terminal, 5VDC (not shown) 1136 2015

150 Cooper Rd. (F-15)
 W. Berlin, NJ 08091

www.tagcords.com

Telephone: (856) 753-8585
 Fax : (856) 768-7645

Telecom Assistance Group

5ESS Terminal Replacements - Dual Session

Model:

TT-DCAPCE



Includes:

- (1) 17" Flat Screen Monitor
- (1) Dumb Terminal Controller
- (1) Keyboard
- (1) Quick Guide
- (2) 400701,
(DB25M Gender Changer)



SPECIFICATIONS

- VT-100 COMPATIBLE
- DUAL RS-232 INPUTS
- PRINTER OUTPUT
- LOW POWER

Printer Port Type:



Parallel *

* If a Serial Port is needed, please order the 5ESS KIT, # TT-DCAPC-ESSKIT which includes a Parallel to Serial Adapter # TT-PSA.

Ordering Information:

TT-DCAPCE

Dual Craft Access System - 5ESS

includes: (1) 17" Flat Screen Monitor, (1) Keyboard,
(1) Dual Session Dumb Terminal Controller, (1) Quick Guide &
(2) # 400701 (DB25M Gender Changer)

**VZ ID #
1118 2245**

TT-DCAPC-ESSKIT

Dual Craft Access System - 5ESS Kit

includes: (1) 17" Flat Screen Monitor, (1) Keyboard,
(1) Dual Session Dumb Terminal Controller, (1) Quick Guide,
(2) # 400701 (DB25M Gender Changer) &
(1) # TT-PSA**
(Parallel to Serial Printer Adapter w/ AC Power Pack) **not shown

**KIT VZ ID #
1118 2244**

TT-DCA5-PP

Replacement Power Pack for 5ESS Terminal, 5VDC (not shown)

1136 2015

150 Cooper Rd. (F-15)
W. Berlin, NJ 08091

www.tagcords.com

Telephone: (856) 753-8585
Fax : (856) 768-7645

Telecom Assistance Group

5ESS MCC Terminal w/ "Glass Printer" Feature

NEW "Glass Printer" Feature allows Capture of ROP & Scroll Reports

Benefits:

- CAPTURE SCROLLING REGION & ROP INFORMATION WITHOUT PAPER
- ELIMINATE OLD TERMINALS, READ ONLY PRINTERS & PAPER WASTE

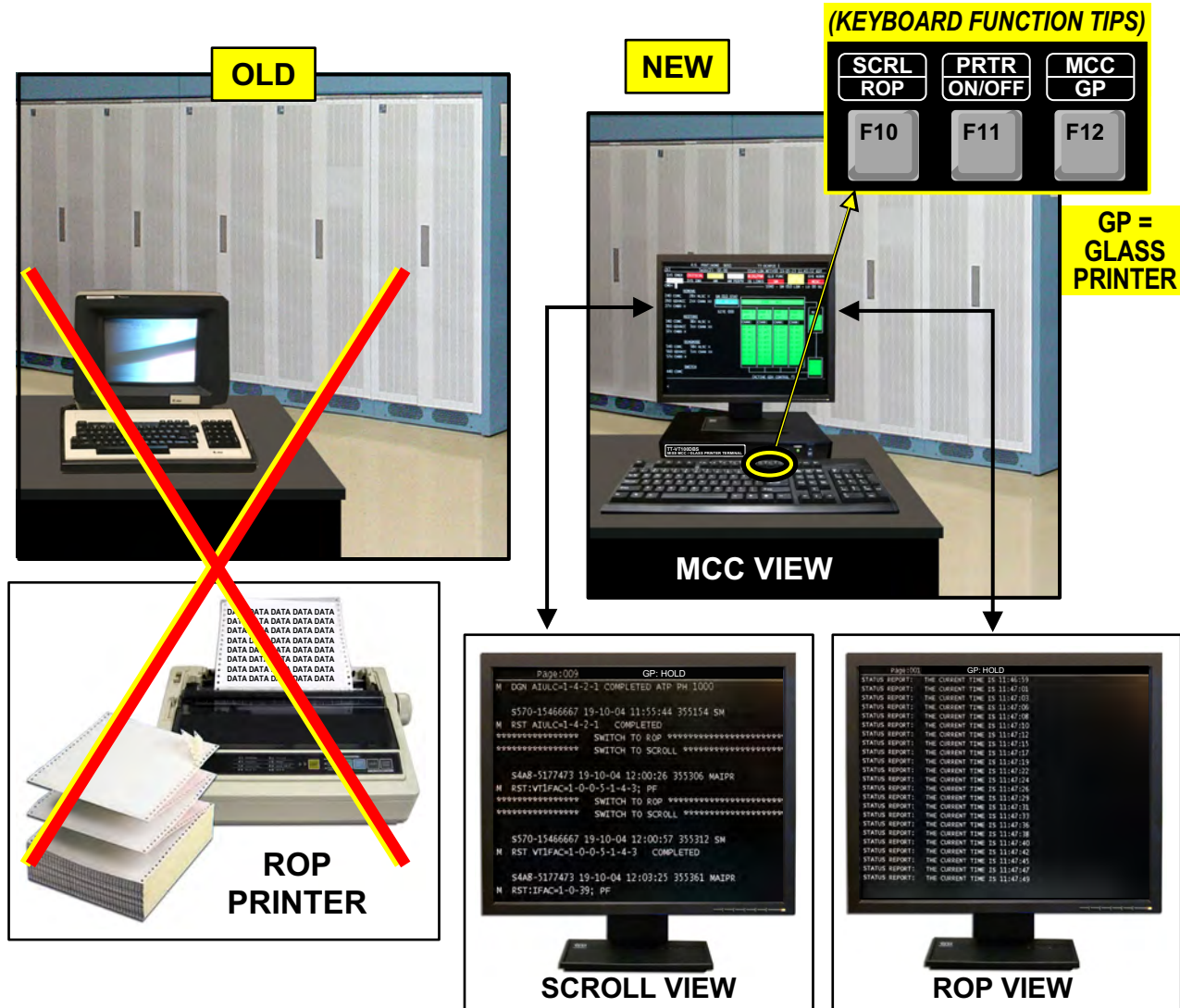

Ordering Information:

TT-VT100DBS 5ESS MCC Terminal w/ "Glass Printer" Feature

includes: (1) 17" Flat Screen Monitor, (1) Keyboard,
 (1) MCC Terminal Controller w/ Glass Printer (Capture Scroll & ROP),
 (2) # 400701, DB25M Gender Changers & (1) Quick Guide

**VZ ID #
1137 2216**

150 Cooper Rd. (F-15)
 W. Berlin, NJ 08091

www.tagcords.com

Telephone: (856) 753-8585
 Fax : (856) 768-7645

Telecom Assistance Group

5ESS "Pre-Charge" Tool

T-5ESSPCT

5ESS Fuse Bay Control Panel,
Lucent # ED-83024-30

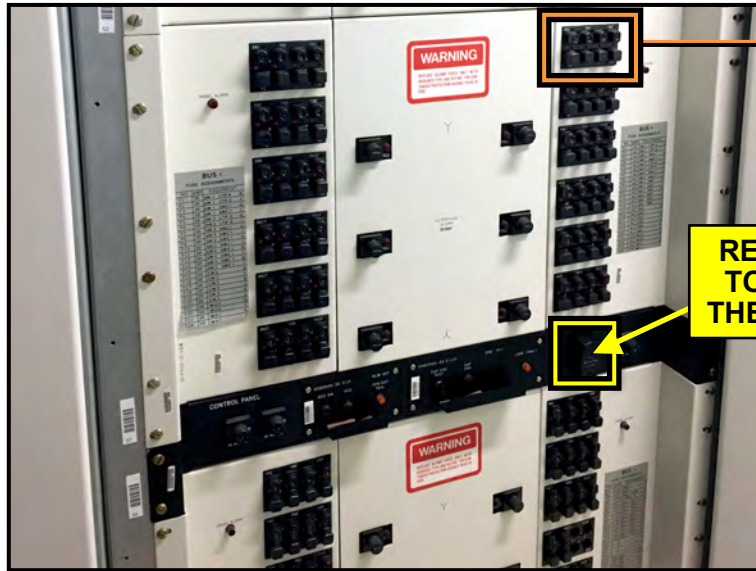

**REPLACES BROKEN
TOOL LOCATED ON
THE CONTROL PANEL**

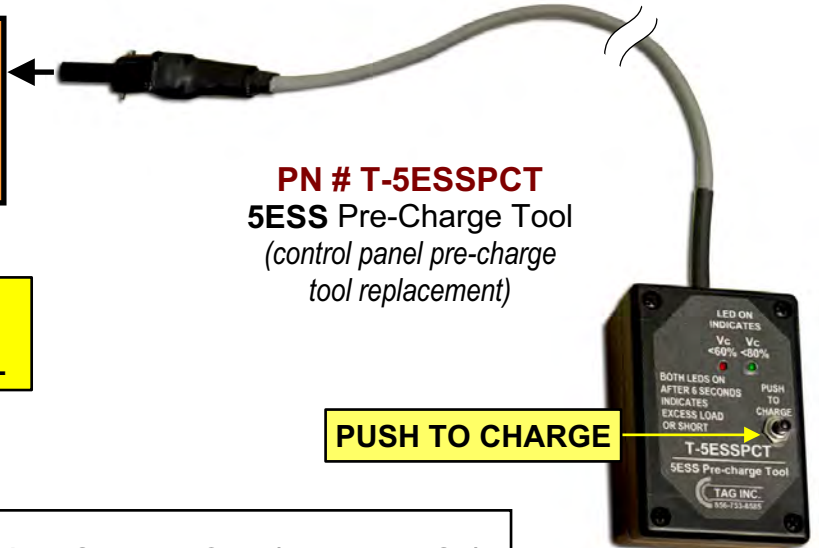

PN # T-5ESSPCT
5ESS Pre-Charge Tool
*(control panel pre-charge
tool replacement)*

PUSH TO CHARGE

1. INSERT PROBE (ALARM FUSE)
2. PRESS TEST BUTTON
3. RED & GRN LEDS WILL LIGHT
4. 4-6 SEC LEDS WILL GO OUT
5. INSTALL MAIN FUSE
6. IF RED LED STAYS ON EXCESS LOAD OR SHORT IS PRESENT

Application:

TAG's PN # T-5ESSPCT is used to pre-charge shelf power capacitors of a 5ESS switch. This allows a new fuse to be installed without seeing full in-rush surge current. The indicator light goes out when it is safe to install the fuse.

Ordering Information:

T-5ESSPCT

5ESS "Pre-Charge" Tool for Capacitor Charging at Main Fuse Bay
(control panel pre-charge tool replacement)

VZ ID # 7501 6258

VZB ID # 1096 8273

150 Cooper Rd. (F-15)
W. Berlin, NJ 08091

www.tagcords.com
Telecom Assistance Group

Telephone: (856) 753-8585
Fax : (856) 768-7645

New Replacement Dumb Terminals - Transport / DACS Equipment

NEW TERMINAL WORKS ON
Titan 5500, CS1, CS1L, DACS II, III, IV, Alcatel 1631 & HDSL
(Titan 5500 shown below)

REMOVE & REPLACE OLD / BROKEN CRTs



SPECIFICATIONS

- VT-100 COMPATIBLE
- PRINTER OUTPUT
- RS-232 INPUT(S)
- LOW POWER

Ordering Information:

		<u>VZ ID #</u>
TT-VT100S	Single Session Dumb Terminal - Transport includes: (1) 17" Flat Screen Monitor, (1) Keyboard, (1) Single Session Terminal Controller, (1) DB25M Gender Changer & (1) Quick Guide	1131 9854
TT-SCA1631	Single Session Dumb Terminal - 1631 DACS includes: (1) 17" Flat Screen Monitor, (1) Keyboard w/ 1631 labels, (1) Pre-configured 1631 Single Session Terminal Controller, (1) DB25M Gender Changer & (1) 1631 Quick Guide	1136 2874
TT-DCT55	Dual Session Dumb Terminal - Titan 5500 includes: (1) 17" Flat Screen Monitor, (1) Keyboard, (1) Pre-configured Titan 5500 Dual Session Terminal Controller, (2) DB25F Gender Changers & (1) Titan 5500 Quick Guide	1131 5065

150 Cooper Rd. (F-15)
W. Berlin, NJ 08091

www.tagcords.com

Telephone: (856) 753-8585
Fax : (856) 768-7645

Telecom Assistance Group

DMS Terminal Replacements - Dual Session

Model:

TT-DCAP-DMSKIT

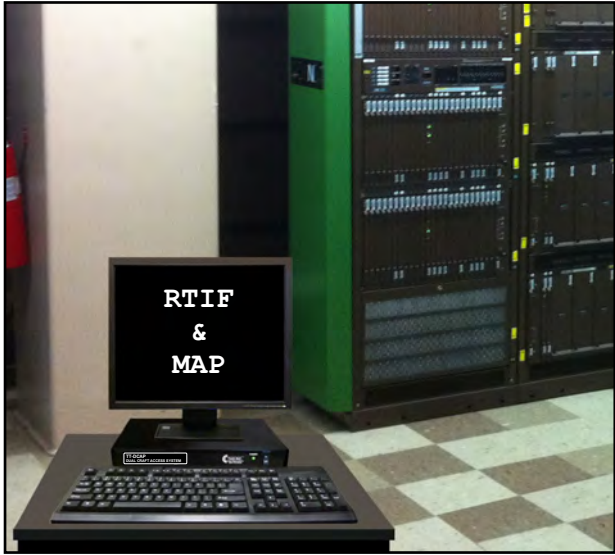

Kit Includes (TT-DCAP-DMSKIT):

- (1) 17" Flat Screen Monitor
- (1) Dumb Terminal Controller
- (1) Keyboard
- (1) Quick Guide
- (2) 400700, (DB25F Gender Changer) 
- (2) 400725SB2, (DMS Quick Connect Current Loop Adapter Cable w/ DEC Connector)



SPECIFICATIONS

- VT-100 COMPATIBLE
- DUAL RS-232 INPUTS
- PRINTER OUTPUT
- LOW POWER

Printer Port Type:



Parallel * * If a Serial Port is needed, please order a Parallel to Serial Adapter # TT-PSA, VZ ID # 1118 2239.

Ordering Information:

TT-DCAP-DMSKIT	Dual Craft Access System - DMS (Kit 1) includes: (1) 17" Flat Screen Monitor, (1) Keyboard, (1) Dual Session Dumb Terminal Controller, (1) Quick Guide, (2) # 400700 (DB25F Gender Changer) & (2) # 400725SB2 (DMS Quick Connect Current Loop Adapter Cable w/ DEC Connector)	KIT VZ ID # 1133 0726
TT-DCAP-DMSKIT2	Dual Craft Access System - DMS (Kit 2) includes: (1) 17" Flat Screen Monitor, (1) Keyboard, (1) Dual Session Dumb Terminal Controller, (1) Quick Guide, (2) # 400700 (DB25F Gender Changer), (2) # 400725SB2 (DMS Quick Connect Current Loop Adapter Cable w/ DEC Connector) & (2) # 400725SBW** (Hardwire Adapter for 400725SB2) **not shown	KIT VZ ID # 1133 0728
TT-DCAP	Dual Craft Access System - DMS includes: (1) 17" Flat Screen Monitor, (1) Keyboard, (1) Dual Session Dumb Terminal Controller, (1) Quick Guide & (2) # 400700 (DB25F Gender Changer)	VZ ID # 1133 0727
TT-DCA5-PP	Replacement Power Pack for DMS Terminal, 5VDC (not shown)	1136 2015

150 Cooper Rd. (F-15)
W. Berlin, NJ 08091

www.tagcords.com

Telephone: (856) 753-8585
Fax : (856) 768-7645

Telecom Assistance Group

DMS/100/10 Current Loop Adapters & Accessories

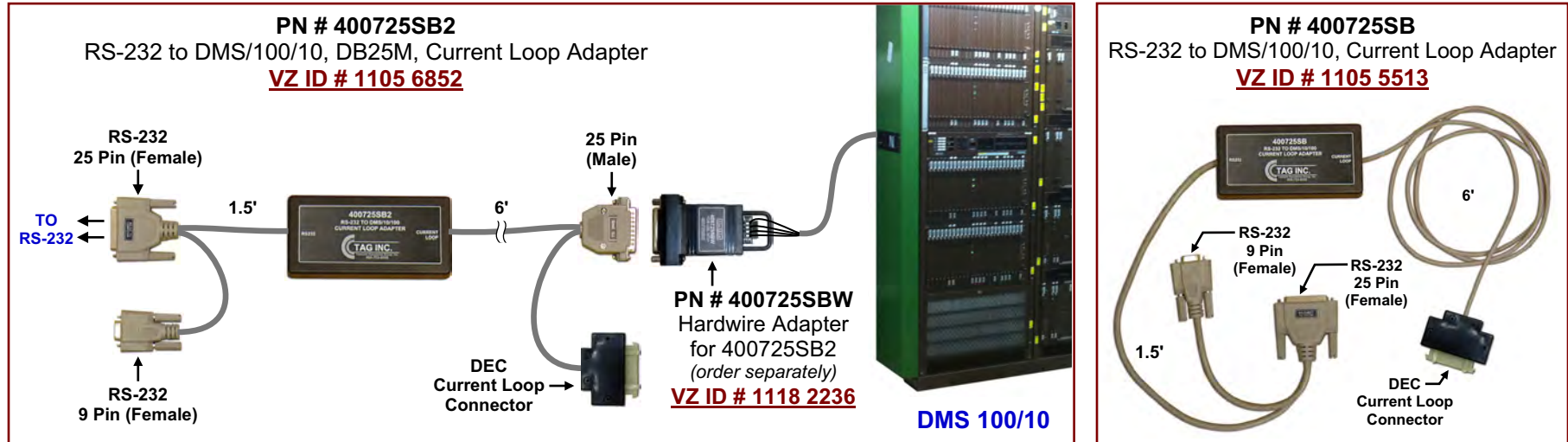

Application:

TAG's Current Loop Adapters (PN# 400725SB & 400725SB2) are used to program and troubleshoot a DMS. The Hardwire Adapter (PN # 400725SBW) connects the TX (+/-) and RX (+/-) current loop wires to a 25 Pin female connector. It is used with the 400725SB2 Current Loop Adapter when the DMS 100/10 System doesn't have a DEC connector.



Ordering Information:

		VZ ID #
400725SB	RS-232 to DMS/100/10 Current Loop Adapter	1105 5513
400725SB2	RS-232 to DMS/100/10, DB25M Current Loop Adapter	1105 6852
400725SBW	Hardwire Adapter for 400725SB2	1118 2236
400725LB	DB25M to DB25F Mini Tracer	1128 5345
400709LB	DB9M to DB9F Mini Tracer	1128 5344
400725NL	DB25F to DB25M (Orange) Null Adapter <i>(not shown)</i>	1128 5343
400721D-12	DMS Interface Cord, Dual Bantam to DB25F, (12') (used with 400725SB2) <i>(not shown)</i>	1105 6851
400725SBPS	Power Supply for 400725SB/2 <i>(optional - not shown)</i>	1118 2238
TT-DCA5-PP	Replacement Power Pack for Single/Dual Session Terminals, 5VDC <i>(not shown)</i>	1136 2015

150 Cooper Rd. (F-15)
W. Berlin, NJ 08091

www.tagcords.com
Telecom Assistance Group

Telephone: (856) 753-8585
Fax: (856) 768-7645

DMS-10/100 Pre-Charge Tool

T-DMSTBT

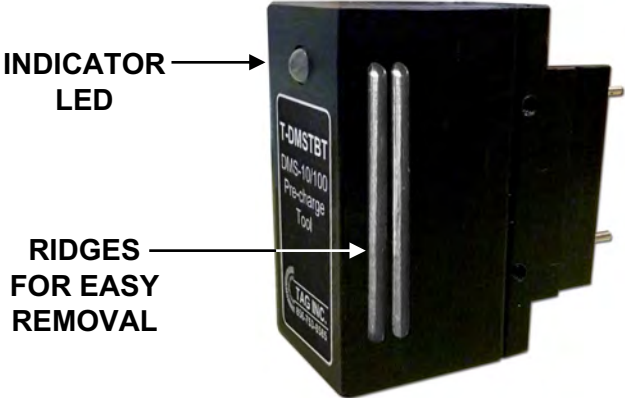

PN # T-DMSTBT
 DMS-10/100 Pre-Charge Tool
VZ ID # 1132 1287

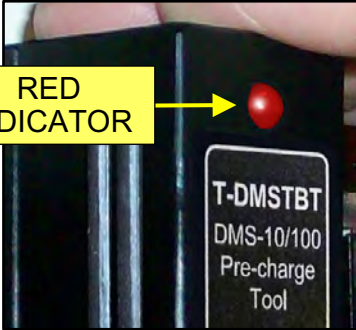

- THE INDICATOR GOES OUT WHEN IT IS SAFE TO INSTALL THE FUSE (APPROX. 10 SEC).
- IF THE INDICATOR STAYS LIT, THERE IS A LOAD OR FAULT ON THE CIRCUIT.

Application:

TAG's # T-DMSTBT is used to pre-charge shelf power capacitors on a DMS-10/100 switch. This allows a new fuse to be installed without seeing full in-rush surge current. The indicator light goes out when it is safe to install the fuse.

Ordering Information:

T-DMSTBT

DMS-10/100 Pre-Charge Tool

VZ ID #

1132 1287

150 Cooper Rd. (F-15)
 W. Berlin, NJ 08091

www.tagcords.com

Telephone: (856) 753-8585
 Fax : (856) 768-7645

Telecom Assistance Group

Verizon Approved - NEBS Certified - DPP Disk Drive Solutions from TAG

**NORTEL DMS-100 SWITCH
w/ EXISTING DPP DRIVES (w/ "MOVING PARTS")**



**NEW REPLACEMENT
SOLID STATE
SCSI DRIVE MODULE
FROM TAG**



(BACK VIEW)

NEW DPP AMA DISK DRIVES AVAILABLE FROM TAG

TAG MODEL #	Replaces PN / HECI			
TSD-6M72BA	NT6M72BA / ENPQBB61XX	140 mb	non turbo	CLEI: 9937433 *
TSD-6M72DA	NT6M72DA	380 mb	non turbo	CLEI: 9937501 *
TSD-6M72DD	NT6M72DD	380 mb	turbo	VZ ID# 1132 2154
TSD-6M72EA	NT6M72EA / ENPQ72EAAA	760 mb	turbo	CLEI: 9937767 *
TSD-6M72GA	NT6M72GA / AMPQADFJAA NT6M72JA / AMPQAECJAA	1 gb	turbo	CLEI: 9937588 *
TSD-6M72HA	NT6M72HA / AMPQADGJAA NT6M72KA / AMPQAEBJAA	2 gb	turbo	VZ ID# 1132 5748

Application:

TAG can **REPLACE** failing / broken Nortel DMS-100/10 switch Distributed Processing Peripheral (DPP) and Billing Media Converter (BMC) Disk Drives. These systems allow for remote polling of Automatic Message Accounting (AMA) data from the Nortel DMS-100/10 switch to central billing collector sites.

*** Contact Verizon CST / PICS to order CLEIs: 888-225-7427**

150 Cooper Rd. (F-15)
W. Berlin, NJ 08091

www.tagcords.com
Telecom Assistance Group

Telephone: (856) 753-8585
Fax: (856) 768-7645

Verizon Approved - NEBS Certified - Siemens EWSD Drive Solutions from TAG

SIEMENS EWSD w/ EXISTING DRIVES
MAGNETO-OPTICAL (MO) & HARD DISK (HDD)
 (w/ "MOVING PARTS")

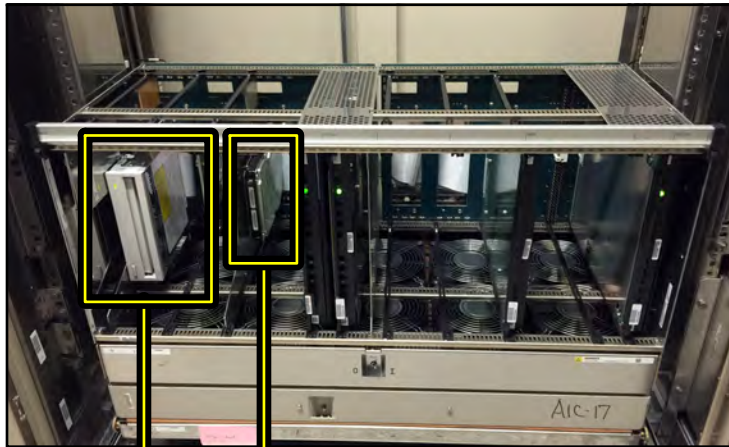

HARD DISK (HDD)

MAGNETO-OPTICAL (MO)

NEW SOLID STATE DRIVES FROM TAG

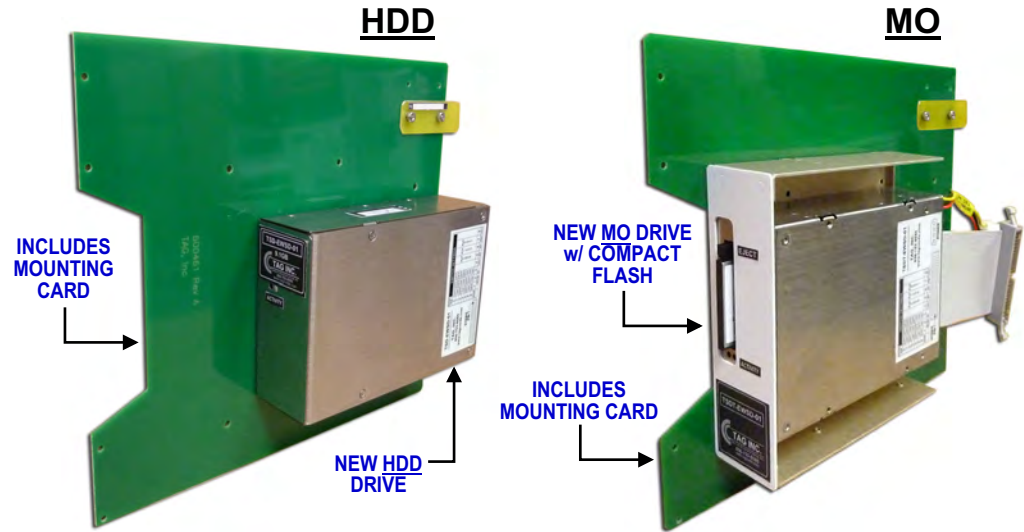

Contact Verizon CST / PICS to order: 888-225-7427

TAG MODEL #	USED IN SIEMENS EWSD HDD MODULE (HECI EQMYAE0DAA)	
TSD-EWSD-01	Solid State Replacement for: Siemens EWSD Module # S30807-U2594-X300 (HECI EQMYAE0DAA) Hard Disk Drive (HDD) w/ Mounting (S30122-U789-X-2 (ST-39173N))	9.1Gb
VZ CLEI 9933201		

TAG MODEL #	USED IN SIEMENS EWSD MO DRIVE MODULE (HECI EGM8JF0BRA)	
TSDT-EWSD-01	Solid State Replacement for: Siemens EWSD Module # S30807-U2593-X200 (HECI EGM8JF0BRA) Magneto-Optical (MO) Drive w/ Mounting (S30122-U563-X400) Includes: 4Gb Industrial Compact Flash Card (PN# TSD-CF-04*)	4Gb
VZ CLEI 9937460		

* Additional Compact Flash Cards are Available:

4Gb (# TSD-CF-04, **VZ CLEI # 9937459**), 8Gb (# TSD-CF-08, VZ ID # 7501 1503) & 16Gb (# TSD-CF-16)

Application:

TAG can **REPLACE** failing / broken Siemens EWSD Magneto-Optical (MO) & Hard Disk (HDD) Drives with **NEW** Solid State Drives.

150 Cooper Rd. (F-15)
 W. Berlin, NJ 08091

www.tagcords.com

Telecom Assistance Group

Telephone: (856) 753-8585

Fax: (856) 768-7645

NEBS Certified - DMS-10 (NT4T32BA) Disk Drive Solution from TAG

**NORTEL DMS-10 NT4T32BA MODULE
w/ Magneto-Optical (MO) Drive (w/ "MOVING PARTS")**

NEW SOLID STATE DRIVE FROM TAG

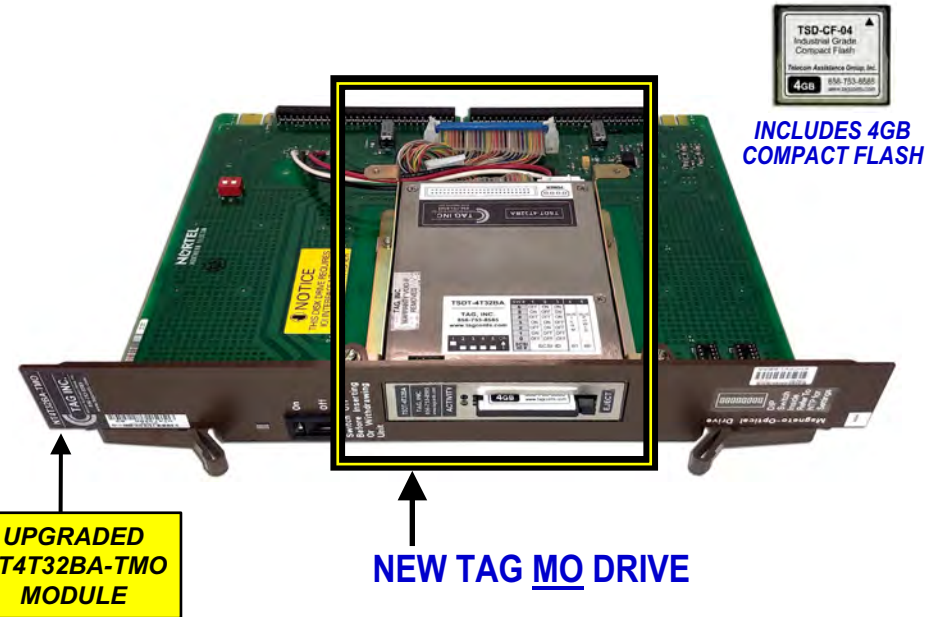
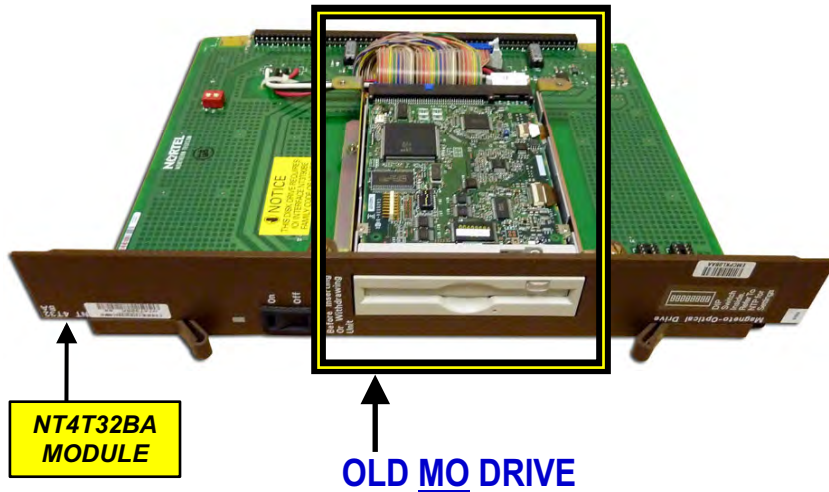

Application:

TAG can **REPLACE** the failing / broken Nortel DMS-10 Magneto-Optical (MO) Drive in the NT4T32BA Module with a **NEW** Solid State Drive.

(TAG installs a new Solid State Drive on your NT4T32BA module & returns it to VZ PICS)

Contact Verizon CST / PICS to order: 888-225-7427

TAG MODEL #	NT4T32BA MODULE (HECI EMCPKL0BAA)
NT4T32BA-TMO	Solid State Replacement for: Nortel DMS-10 (HECI EMCPKL0BAA) NT4T32BA (Fujitsu MCF3064 SS) Magneto-Optical (MO) Drive, Includes: 4Gb Industrial Compact Flash Card (PN # TSD-CF-04*)
VZ CLEI 9933014	
* Additional Compact Flash Cards are Available: 4Gb (# TSD-CF-04, VZ CLEI # 9937459), 8Gb (# TSD-CF-08, VZ ID # 7501 1503) & 16Gb (# TSD-CF-16)	

150 Cooper Rd. (F-15)
W. Berlin, NJ 08091

www.tagcords.com
Telecom Assistance Group

Telephone: (856) 753-8585
Fax : (856) 768-7645

D4 Channel Check Unit

T-D4CC

Need a CMC 5151 Channel Chek Unit ?

TAG has a Replacement Model for this previously discontinued part....



PN # T-D4CC
D4 Channel Check Unit



Application:

TAG's PN # T-D4CC replaces defective CMC 5151 Chek Units which are currently discontinued by the manufacturer.

Ordering Information:

T-D4CC

D4 Channel Check Unit

VZ ID #
1136 9551

150 Cooper Rd. (F-15)
W. Berlin, NJ 08091

www.tagcords.com

Telephone: (856) 753-8585
Fax : (856) 768-7645

Telecom Assistance Group

T-Berd* 209 OSP Auto Test T1 Repeater Test Kit

KIT-209OSP

T-Berd 209 OSP Test Set *(not included)*



(1) PN # 400209OSP
15 Pin D (male) to
Bendix Connector, (10')

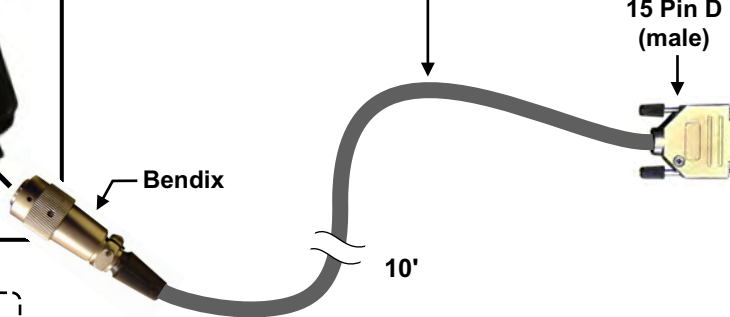

(1) PN # EXT-209OSP
T-Berd 209 OSP "Smart" Repeater Adapter
w/ 15 Pin D Connector
(includes Finger Guard # EXT-209FG)



Finger Guard
(included)



KIT INCLUDES CARRYING CASE

(1) PN # 600209N
Carrying Case
Approx. Dimensions:
9" (H) x 16" (L)

Also Available:



PN # BR-209OSP

Battery Replacement for T-Berd
(not included in kit - order separately)

Application:

The TAG PN # 400209OSP is an auto-test replacement cable for the T-Berd 209 OSP Test Set. It connects from the Bendix connector on the Test Set to the 15 pin female connector on the "Smart" Repeater Adapter (PN # EXT-209OSP).

Ordering Information:

KIT-209OSP

T-Berd 209 OSP Auto Test T1 Repeater Test Kit

includes: (1) EXT-209OSP, T-Berd 209 OSP "Smart" Repeater Adapter
w/ 15 Pin D Connector *(includes Finger Guard # EXT-209FG)*
(1) 400209OSP, 15 Pin D (male) to Bendix Connector, (10') & (1) 600209N - carrying case

VZ ID #
7501 0593

400209OSP

15 Pin D (male) to Bendix Connector, (10')

1136 2878

BR-209OSP

Battery Replacement for T-Berd 209 *(order separately)*

1131 4467

BR-107A

Battery Replacement for T-Berd 107A *(not shown)*

1131 2902

BR-107A-PP

Replacement Power Pack for T-Berd 107A *(not shown)*

1131 9916

150 Cooper Rd. (F-15)
W. Berlin, NJ 08091

www.tagcords.com

Telecom Assistance Group

Telephone: (856) 753-8585
Fax : (856) 768-7645

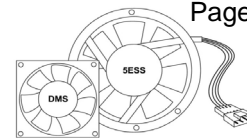

Part #	Description	VZ ID #
5ESS FANS		
TF-5ESS-01P	KS22501L3 Equiv. 5ESS , 48V Fan w/ 3 Leads & AMP Connector (w/ power prongs)	11319502
TF-5ESS-01F	KS22501L3 Equiv. 5ESS , 48V Fan w/ 3 Leads & Faston Connector (w/ power prongs)	11295311
TF-5ESS-02P	KS23912L1A Equiv. 5ESS , 48V Fan w/ 5 Leads & AMP Connector (w/ Internal Thermal Speed Control Sensor)	11294862
TF-5ESS-02F	KS23912L1A Equiv. 5ESS , 48V Fan w/ 5 Leads & Faston Connectors (w/ Internal Thermal Speed Control Sensor)	11294863
TF-5ESS-03P	KS23912L2 Equiv. 5ESS , 48V Fan w/ 4 Leads & AMP Connector	11295310 (VZ) 10959990 (VZB)
TF-5ESS-04P	KS22501L3A Equiv. 5ESS , 48V Fan w/ 5 Leads & AMP Connector	11294861
TF-5ESS-04F	KS22501L3A Equiv. 5ESS , 48V Fan w/ 5 Leads & Faston Connectors	11294860
TF-5ESS-10P	KS23398L2 Equiv. 5ESS , 48V ISLU (Square Fan) w/ 5 Leads & AMP Connector	11328317
ADTRAN FANS		
TF-TA3000-01	Adtran TA3000 , 48V Fan w/ 3 Wire Plug (109P0848H401) (for HECI: M3PQ0AV, 1181006L1)	
TF-TA5K-01	Adtran TA5000 , 48V Fan w/ 4 Wire Plug	
TF-TA5K-02	Adtran TA5000 , 48V Fan w/ 3 Wire Plug	
ALCATEL FANS		
TF-AL1000-01	Alcatel 1000/7300 , 48V Fan w/ 3W Plug & Tach (use in 3EC 15478 & 3EC 37933 (XXXX))	11292238
TF-AL7300-02	Alcatel 7300 , 48V Fan w/ 3 Wire Plug, Sensor & Tach (use in 3EC 16697 (XXXX) tray)	11292237
TF-DSCECS1-01	DSC / Alcatel ECS1 , 48V Fan w/ 3 Wire Plug	
TF-ALC1603-01	Alcatel 1603 , 48V Fan w/ 3 Wire Plug (use in Low-Volume Fan Tray # 625052-000-0XX)	
TF-ALC1631-01	Alcatel 1631 , 48V Fan (Square) w/ Power Prongs (use in Assembly # 695-3363-302)	
TF-ALC1631-02	Alcatel 1631 , 48V Fan (Round) w/ Power Prongs & Tach Lead (use in #3AL45446AA)	75013926
TF-ALC1631-03	Alcatel 1631 APS , 48V Fan (Square) w/ Pwr Prongs & Tach Lead (use in #695-8489-001)	
TF-ALC1680-01	Alcatel 1680 OGX , 48V Fan (Round) w/ Pwr Prongs & Tach Lead (use in #3EM04820AA)	
BIGBAND / ADC FANS		
TF-BIGBND-01	BigBand , 12V Fan w/ 3 Wire Open End & Speed Control	11321832
TF-BIGBND-03SR	BigBand Shelf / Door Repair (TAG repair service includes: (3) New Fans)	11321831
TF-BIGBPS-01	12V Fan (40mm) w/ 3 Wire Plug for BigBand (FTTP bays) & ADC RF Worx Power Supplies	
CIENA FANS		
TF-CN3916-KIT	12V (40 x 40 x 10mm) Fan Kit for Ciena 3916 (includes (2) 3 Wire, 4 Pin fans)	
TF-CN3916	(1) Individual 12V (40 x 40 x 10mm) Fan for Ciena 3916 w/ 3 Wire, 4 Pin Plug	
TF-CN1600-01	Ciena 1600 DWDM , 48V Fan (fan only, mtg bracket is not included)	11329652
TF-DN7100-01	Ciena DN7100 , 12V Fan w/ 3 Wire Plug (TA225DC Equiv.)	
TF-DN7100-02	Ciena DN7100 , 12V Fan w/ 3 Wire Plug (TA300DC Equiv.)	
CISCO 15454 / CALIX E7 / KENTROX FANS		
TF-C15454-01	Cisco ONS 15454 , 48V Fan w/ 3 Wire Right Angle Conn. (use in HECI: WMMYAFEGAA)	
TF-CLXE7-01	Calix E7-2 FTA2 Fan Unit , 12V (40mm x 20mm) Fan for w/ 4 Wire Plug	
TF-AI-180	Kentrox AISwitch Series 180 , 48V Cooling Fan w/ 3 Wire Right Angle Connector	
DSC DEX600E FANS		
TF-DEXLAP-01	DEX600E MSP Bay, 48V Fan (LAP Fan) (155-2936-055 Equiv. LAP)	11373904 (VZ) 10732506 (VZB)
TF-DEXDSI-01	DEX600E DSI Bay, 48V Fan (500-0000-294 Equiv. DSI (FAIC) type cards)	11367096 (VZ) 10732518 (VZB)
TF-DEXDTI-01	DEX600E DTI Bay, 48V Fan (400-0063-900 Equiv. DTI (AMM) type cards)	75013389 (VZ) 10732505 (VZB)
TF-DEXCS3-01	DEX600E CS3, 48V Fan	
GTD-5 FANS		
TF-GTD5-01	GTD-5 , 48V Fan w/ 5 Wire Plug	11353519
TF-GTD5AG-01	GTD-5 AG Communications Unit , 48V Fan (60x25mm) w/ 3 Wire Plug	
DATAKIT / GALAXY RECTIFIER / FUJITSU FANS		
TF-DATAKIT-01	24V Fan for Datakit System w/ 3 Wire, 4 Pin Connector	
TF-GLX595LTB-01	48V Fan for Galaxy 595LTB Rectifier w/ 4 Wire Plug	
TF-FLM150-01	48V (80mm) Fan for Fujitsu FLM 150 Fan Tray w/ 3 Wire Plug	
TF-FW4500-01	48V Fan for Flashwave 4500 Fan Unit w/ 4 Wire Plug (FC9580FAN1, SNPQUG5AB)	

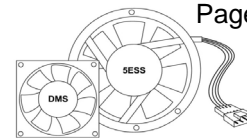

Part #	Description	VZ ID #
LORAIN / MARCONI RECTIFIER FANS		
TFT-MRECT	New Fan Tray Assembly for Vortex Rectifier (Lorain/Marconi 104545) (V200D50)	
TF-MREC-01	Vortex Rectifier (Lorain / Marconi) (V200D50), 24V Fan w/ 3 Wire Open End	
TF-MREC-02	Vortex Rectifier (Lorain/Marconi), 24V Fan & 3 Wire Plug (use in V200E50)	
TF-RHM400-01	RHM-400/800 Rectifier Unit (Lorain/Marconi), 220VAC Fan	
TF-LRA50B50-01	Lorain Rectifier (A50B50), 48V Fan w/ 2 Wire Plug	
TF-LRV50B50-01	Lorain Rectifier (V50B50), 24V Fan w/ 3 Wire Plug	
LUCENT FANS (CBX500, DDM-2000, METROPOLIS, FT-2000, DACS III / IV)		
TF-DDM201	Lucent DDM-2000, 24V Fan (fan only, mtg not included)	11288829
TF-DDM201-KIT1	Lucent DDM-2000, 24V Fan Kit w/ Mounting Plate	11288830
TF-DDM202	Lucent DDM-2000, 48V Fan (use in Comcode: 408741205) (fan only)	11329288
TF-CBX500-01	Lucent CBX500 OCD, 12V Cooling Fan w/ 3 Wire Pins	11292236
TF-FT201	Lucent Fiber Terminal 2000 (FT-2000), 48V Fan	11322844
TF-DMXMET-01	Lucent Metropolis DMX, 48V Fan (use in Comcode: 408769172)	11353516
TF-DMXMET-02	Lucent Metropolis DMX Access Multiplexer, 48V Fan w/ 4 Wire Black Plug	
TF-DACS3/4-01	Lucent DACS III / IV, 48V Fan w/ 4 Wire Plug (KS23913L1 Equiv.)	11323268
TF-DACS3/4-02	Lucent DACS III / IV, 48V Fan w/ 5 Wire Plug (KS23913L1 Equiv.)	
TF-DACSK1-01	Alcatel-Lucent DACS K01, 48V Fan w/ 3 Wire Open End (includes (3) butt splices)	75016131
NEC FANS		
TF-NEC-01	NEC, 48V Fan (fan only) (FD-31201A / FD-32401A)	11315421
TF-NEC01-KIT1	NEC, 48V Fan Kit w/ Mtg. Plate & Grill (FD-31201A / FD-32401A)	11315422
TF-NEC-02	NEC, 48V Fan (fan only) (ITS-2400)	11315423
TF-NEC02-KIT1	NEC, 48V Fan Kit w/ Mtg. Plate & Grill (ITS-2400)	11315424
TF-NEC-03	NEC, 48V Fan (fan only) (ITS-2400V FL)	11315425
NORTEL FANS (DMS, Carrier VoIP, DPCC SuperNode "Squirrel Cage" Blowers)		
TF-DMS01	DMS-100, 48V Fan w/ Power Prongs (use in NT3X90AC / NTB63AA fan trays)	11279688
TF-DMS02	DMS-1U, 48V Fan w/ Power Prongs (unthreaded) (use in NT3X90AC / NTB63AA fan trays)	11287009
TLMP-DMFA-10	DMS Fan Alarm Repl. Lamp ("Fan Fail" / "Frame Fail") (QTY of 10)	CLEI 9933190
TLMP-DMFA-25	DMS Fan Alarm Repl. Lamp ("Fan Fail" / "Frame Fail") (QTY of 25)	11353521
TLMP-DMSA-10	DMS Aisle Alarm Repl. Lamp (QTY of 10)	CLEI 9933191
TFT-DMS48KIT4	DMS-100 (NT3X90AA / NT3X90AB), 24VAC to 48VDC Fan Tray Conversion Kit 4 (NEW Kit - includes (5) 48V Fans & Fan Control Board w/ built in Sensors (no paddles needed))	11369386
TFT-3X9013T ***NEW TRAY***	TAG Universal DMS-100 3X9013 Fan Tray (NEW TRAY is pre-assembled w/ (5) NEW fans, Alarm Board, Wiring Harness w/ Connector & Universal Mounting Holes for NT3X90AA, NT3X90AB, NT3X90AC & NT3X90AF cooling units) - No 24VAC Inverters - No Paddle Sensors	75013628 (VZ) 10959500 (VZB)
TFR-BX63AA-K01	DMS NTB63AA Fan Unit Paddleless Upgrade Kit (ISDN LCME LCEI Bay) (Includes: (5) TF-DMS03, 48V Fans, (1) TFC-BX63AA-01, Fan Alarm Control Board w/ Mounting Bracket, (1) TFCS-DMSBX63, Wiring Harness & (1) Installation Guide)	75016125 (VZ) 10968113 (VZB)
TF-DMS03	DMS-100, 48V Fan w/ TTL Tach & 3 Wire Plug (use in NT3X90AF fan trays)	11292450
TFC-3X90AF-01	DMS-100, Fan Alarm Board for the NT3X90AF Cooling Fan Unit	
TFR-3X90AF-01	TAG Refurbishing - DMS-100 NT3X90AF Fan Tray (Includes: (1) Recycled NT3X90AF Fan Tray w/ (5) TF-DMS03, 48V Fans, (1) TFC-3X90AF-01, Fan Alarm Control Board & 2yr Warranty)	11380203
TF-DMS04AC	DMS-100, 24VAC Fan w/ Power Prongs (use in NT3X90AA / NT3X90AB fan trays)	11289907
TF-RX50FF-01	DMS SDM, 12V Fan w/ 3 Wire Plug & Speed Control (use in Nortel shelf # NTRX50FF)	75013418
TF-DMS-NTRX91	DMS-100, 48V Fan w/ 3 Wire Plug (use in NTRX91AA / NTOX91AA fan units)	11330237
TF-DMS10-01	DMS-10, 48V Fan w/ Power Prongs	11323144
TF-DMS-FOS	Nortel IW SPM-IP, 48V Fan for NTLX56AA Fan Assemblies (fan only)	75013417
TF-MG9K-01	Nortel / GENBAND Media Gateway 9000, 48V Fan w/ 3 Wire Plug	11351548
TF-DMSLGN6-01	DMS-500/250 DPCC (225mm) Impeller Fan for XA-Core Blower Drawer w/ 4 Wire Plug (fan only, use in existing tray # NTLX10AA, drawer # NTLX11AA)	75013252
TF-DMSMCL-02	DMS-100 Dual-Scroll Blower Unit w/ (1) 4 pin plug & (1) 3 pin plug (w/ adapter cable) (used in NT9X950 "w/ hanging blowers" (replaces # A0383325 & A0381714)) (DPCC / LIM / ENET bays)	75013440 (VZ) 10862338 (VZB)
TFC-DMSAPW-3	Alarm Board Replacement for DMS LIM / ENET Blower	
TF-DMSLGN5A	DMS-100 DPCC XA-Core SuperNode Blower "Squirrel Cage" Replacement w/ 4 Wire Square Plug Adapter Cable (# TFCS-DMSLGN5F2S) (use in NT9X01BC DPCC w/ Power Distribution Alarm Board (replaces A0345301))	75015910

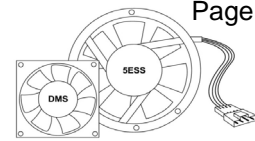

Part #	Description	VZ ID #
SIEMENS EWSD FANS		
TF-EWSD-01	Siemens EWSD, Square 48V Fan w/ Power Prongs (<i>fan only, use with existing guard grill</i>)	11329119
TF-EWSD-02	Siemens EWSD, Round 48V Fan w/ Power Prongs (<i>fan only, use with existing guard grill</i>)	75013241
STROMBERG CARLSON DCO FANS		
TF-DCOCMF-01	48V Fan for Stromberg Carlson DCO CMF Bay w/ 3 Leads & Fastons	
TF-DCODCF-01	48V Fan for Stromberg Carlson DCO DCF Bay w/ 3 Leads & Spade Lugs	
TF-DCONHD-01	48V Fan for Stromberg Carlson DCO Non-HD CMF Bay w/ 2 Wire Open End	
TF-DCOMEF-01	48V Fan for Stromberg Carlson DCO MEF Bay (80mm x 45mm) w/ 3 Wire Plug	
TF-DCO-02	48V Fan for Stromberg Carlson DCO CMF / DTF Bay w/ 3 Leads & Fastons	
TELCO SYSTEMS FANS (EDGELINK 100)		
TF-EL100	Edgelink 100, Fan (40mm)	11294163
TF-EL100DET	Edgelink 100, Detector PC Board (<i>Equiv. to CCA591G1</i>)	11294165
TF-EL100-KIT2	Edgelink 100, Fan Kit (40mm)	11294164
TF-EL100-02	Edgelink 100, Fan (35mm)	
TF-EL330-01	Edgelink AXX330G1, Fan (80mm) w/ 3 Wire Plug	
WAVESTAR / WIDEBAND 3190 / STP RING NODE FANS		
TF-WSTR-01	WaveStar TDM 10G, 48V Fan w/ 3 Wire Plug	57019631
TF-WB3190	Wideband 3190, 48V Fan w/ 3 Wire Plug	11314379
TF-STPRN-01	STP Ring Node Frame / Cabinet, 48V Fan w/ 5 Wire Plug (<i>use in HECI E5DYAAC</i>)	
OSP CABINET / TRAY FANS & ALARM CONTROL UNITS		
TF-NTOPAC	48V Fan for Nortel Opac / OPM Cabinet w/ Round Weatherproof Connector	11323852
TF-NTOPAC-3	48V Fan for Nortel Opac / OPM Cabinet w/ 3 Wire Open End	11323853
TF-NTOPAC-02	48V Fan for Nortel Opac / OPM Cabinet w/ Sealed 3 Pin Plug	11323854
TF-NTOPAC-04	48V Fan for Nortel Opac / OPM Cabinet w/ Sealed 3 Pin Plug	
TF-NTOPAC-05F	48V Fan for Nortel Opac Access Node Tray / 800A Cabinet (square fan) w/ Power Prongs & Unterminated FPS Lead (<i>use in Tray # NT4K0610</i>)	11363304
TF-NTOPAC-05	48V Fan for Nortel Opac Access Node Tray / 800A Cabinet (square fan) w/ 3 Wire (w/ Blue FPS Lead) & 3 Pin Plug (<i>use in Tray # NT4K0610</i>)	11371477
TF-NTANCFT-01	48V Fan for Nortel Access Node/Charles Fan Tray (92-FAN840-X) w/ 3 Wire Plug	
TF-DMS06	48V Fan for Booster Fan Unit (BFU) found in DMS-100 OPM Cabinets w/ Power Prongs, Unterminated Tach Lead & (1) Butt Splice (also used in DMS-1 URBAN EMC RT BAY (fan unit NT4A44AA))	11329386
TFR-8X06ABT	TAG Refurbishing - Paddleless Alarm Conversion Upgrade for NT8X06AB Fan Trays found in DMS OPM Cabinets (Includes (1) Recycled NT8X06AB Fan Tray upgraded w/ (4) 48VDC DMS OPM Fans & (1) Alarm Control Board (no paddles needed)(includes mounting bracket))	75008058
TF-SLC201-02	48V Heat Exchanger for 80 Type Cabinet w/ Screw on Connector (<i>KS23912L4 Equiv.</i>)	
TFC-114A-01	114A Fan Control Unit for 80 Type Cabinet HX (<i>equiv. to 106894934</i>)	
TFC-LU4-01	Alarm Control Board for Lucent 4A/4B, 4G/SLC2000 Trays & 114A Control Units	
TF-SLCBC-01	48V Battery Cooling fan for 80 Type Cabinet w/ 3 Wire Plug	
TFC-116A-01	Alarm Control Board for Lucent 116A Battery Fan Unit (<i>customer supplied bracket</i>)	
TF-SLC201	48V Fan for SLC 2000 - Lucent 4A/4B Tray w/ 5 Wire Plug (<i>KS23912L6 Equiv.</i>)	11321261
TF-SLCAPW-01	(1) 48V Fan for SLC 2000 Cabinet Reltec/Mclean APW Tray w/ 3 Wire Open End	
TF-SLCAPW-04	(4) 48V Fans for SLC 2000 Cabinet Reltec/Mclean APW Tray w/ 3 Wire Open End	
TFC-SLCAPW-4	Alarm Control Board for Reltec/Mclean APW Fan Tray	
TF-LU2A	48V Fan for Lucent 2A Fan Tray w/ 3 Leads & Fastons (<i>KS22501L5 Equiv.</i>)	11327079
TF-LU2B	48V Fan for Lucent 2B Fan Tray w/ 3 Wire Plug (<i>KS22501L5A Equiv.</i>)	11323437
TF-SLC5-01	48V Fan for SLC5 Cabinet Lucent 2B Fan Tray w/ 3 Wire Plug (<i>KS22501L5A Equiv.</i>)	11321557
TFC-LU2BC-01	Alarm Control Board for Lucent 2B & 2C Fan Trays (<i>customer supplied tray</i>)	11378148
TF-LU2C	48V Fan for Lucent 2C Fan Tray w/ 3 Wire Plug (<i>KS22501L5A Equiv.</i>)	11327078
TF-ALC7342-01	48V Fan for Nokia 7342 Rolt Fan Tray w/ 4 Wire Plug	
TF-ALC1218-01	24V Fan for Alcatel 1218 Cabinet Tray w/ 2 Wire, 3 Pin Connector	
TF-ALC1218-02	48V Fan for Alcatel 1218 Cabinet Roof w/ 2 Unterminated Leads	

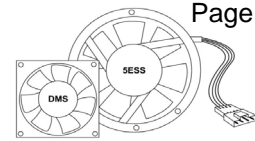

Part #	Description	VZ ID #
OSP CABINET / TRAY FANS & ALARM CONTROL UNITS - continued from previous page		
TF-FUJ6200-01	48V Heat Exchanger for Fujitsu 6200 Cabinet w/ 5 Wire Plug	
TF-FUJ6200-02	48V Fan for Lorain/Marconi M.P.S. Shelf in Fujitsu 6200 Cabinets w/ Power Prongs	
TF-FUJ6200-03	48V Fan for Fujitsu 6200 Cabinet Tray w/ 3 Wire Open End & Power Prongs	
TF-SPB-AC01	120VAC Fan for Seiscor / Pulsecom "B" Cabinet w/ Power Prongs	
TF-SPD-AC01	110VAC Fan for Seiscor / Pulsecom "D" Cabinet w/ Power Prongs & Guard Grill	75004792
TF-DCORLS-01	48V Fan for Stromberg Carlson DCO RLS Cbnt Tray w/ 3 Fastons & Pwr Prongs	
TF-UMC1000-01	48V Fan (120mm) for Tellabs UMC1000 Tray w/ 3 Wire Plug (use in AFC Tray w/ 6 fans)	
TF-UMC1000-02	48V Fan (80mm) for Tellabs UMC1000 Tray w/ 3 Wire Plug (use in AFC Tray w/ 10 fans)	
TF-UMC1000-03	48V Fan (120mm) for Tellabs UMC1000 Tray w/ 4 Wire Plug (use in AFC Tray w/ 8 fans)	
TF-UMC672-01	48V Fan for UMC672 Cabinet w/ 2 Wire Plug (fan only, use with existing metal housing)	75013705
TF-ES660-01	24V (60x25mm) Fan for Lucent ES660 Rectifier Unit w/ 2 Wire Plug	
TF-RECARGUS-01	12V (80mm) Fan for Argus Rectifier w/ 2 Wire Plug	
TF-RECARGUS-02	24V (80mm) Fan for Argus Rectifier w/ 2 Wire Right Angle Plug	75013251
TF-RECARGUS-03	24V (80mm) Fan for Argus Rectifier w/ 2 Wire Right Angle Plug & Threaded Inserts	
TF-RECARGUS-04	12V (120mm) Fan for Argus Rectifier w/ 2 Wire Open End	
TFT-SLC96-AC01	110VAC Fan w/ Bracket Assembly for SLC96 (36 Type) Cabinet (Equiv. to Fan Assembly KS22099L5 found in 36 Type Cabinets)	11352281
TFT-SLC96-AC01L	110VAC (Low Temp) Fan w/ Bkt Assembly for SLC96 (36 Type) Cabinet (KS22099L5)	
TF-SLC96-AC02	110VAC Fan for SLC96 (36 Type) Cabinet (fan only) (includes power wire, (3) butt splices & mounting hardware) (use in KS22099L5)	11352280
TF-NP0402-01	48V Heat Exchanger for Noren Cooling Unit - Internal (6.71K) w/ 3 Wire Open End	
TF-NP0414-02	48V Heat Exchanger for Noren Cooling Unit - External (8.45K) w/ 3 Wire Open End	
TF-LS2000-01	48V Fan for Litespan 2000 PDFA w/ 3 Wire Plug (use in Fan Tray # 500-1126-723)	11326255
TFC-PDFA-X2	Alarm Control Board for Litespan 2000 PDFA Trays (use in Fan Tray # 500-1126-723)	75008219
TF-LS2000-02	48V Fan for Litespan 2000 High Velocity PDFA w/ 3 Wire Connector	11327455
TFC-PDFA-01	Alarm Control Board for Litespan 2000 HV PDFA Trays (use in # 509-0000-086/163)	75008240
TF-LS2000-03	48V Heat Exchanger for Litespan 2000 Cabinet Heat Stack w/ Unterminated Leads	11329780
TF-LS2KSB-01	48V Heat Exchanger for Litespan 2000 Cabinet Heat Stack w/ Power Prongs	75010344
TF-LS2000-44	Litespan 2000 OSP DFA Fan Kit (includes: (4) 48V Fans w/ Guard Grills & (1) Wiring Harness w/ 12 Wire Plug)	11361758
TF-LS2000-04	(1) 48V Fan for Litespan 2000 DFA w/ 3 Wire Open End (use in tray # 500-1100-XXX)	11361757
TFC-DFA-01	Alarm Control Board for Litespan 2000 DFA Fan Trays (use in tray # 500-1100-XXX)	75013160
TF-LPCM-01	24V Fan (80mm) for Lorain Power Conversion Module (V15F50/P) w/ 3 Wire (M) Plug (fan only)	
TF-LPM-01	48V Fan for Lorain Power Module w/ Power Prongs (fan only - use in existing Lorain 427215900 Power Modules)	75010203
TF-MESACL-01	48V Fan for Marconi Current Limiter w/ 3 Wire Plug	
TF-LRA25B50-01	24V Fan for A25B50 Rectifier Unit (Lorain / Marconi) w/ 3 Wire Plug	
TF-ACABTZ-01A	48V Heat Exchanger (Tarzan) for Litespan 2000 (LSC-2030) Cabinet w/ 3 Leads & 2 Connectors (includes Adapter Cable)	11363111
TF-ACABLHX-01	48V Heat Exchanger for Litespan 2000 (LSC-2030) Cabinet (Lower) w/ 3 Leads & 2 Connectors	
TF-MCABTZ-01	48V Heat Exchanger (Tarzan) for Marconi Mesa "Top" HX Cabinet w/ 3 Wire Plug	75002447
TF-MESA6-01	48V Heat Exchanger for Marconi Mesa "Bottom" HX Cabinet w/ 3 Wire Plug	75002448
TF-MARCTOP-01	48V Fan for Marconi Cabinet (Top/Inside) w/ Power Prongs	
TFC-FA400-01	Alarm Control Board Replacement for Marconi Mesa Master Tray	
TF-FA400-01	48V Fan w/ 3 Wire Plug for Marconi Mesa Cabinet Master Fan Tray	
TF-FA400-02	48V Fan w/ 3 Wire Plug for Marconi Mesa Cabinet Slave Fan Tray	
TFC-MARC6-01	6 Position Environmental Control Unit (ECU) for Marconi Cabinet (supports 6 HX fans)	11369996
TF-AI-SCT-01	48V (80mm) Fan for AISCOUT w/ 3 Wire Right Angle Plug	
TF-CN5150HX-01	48V HX for Telamon/Ciena 5150 EMUX Cabinet Door w/ 4 Wires & Seated Connector	
TF-DISCSCPU-01	48V Cooling Fan for DISC*S CPU w/ 2 Wire Open End (fan only, use with existing bracket)	

Part #	Description	VZ ID #
OSP CABINET / TRAY FANS & ALARM CONTROL UNITS - continued from previous page		
TFC-WORX-FAM1	PowerWorx Front Access Fuse Panel (Equiv. to ADC # TFA-FAM)	
TF-MESA384-01	48V (External) HX for Mesa DSLAM 384 Cbnt w/ 4 Wire (Round) (F) Wthproof Plug	
TF-MESA384-02	48V (Internal) HX for Mesa DSLAM 384 Cbnt w/ 4 Wire (Square) Female Plug	
TFC-MESA-04	4 Port Environmental Control Unit (ECU) (used in Mesa 2 - DSLAM 192 & 384)	
TFC-MESA-02	2 Port Environmental Control Unit (ECU) (used in Mesa 2 - DSLAM 192 Type Cabinets)	
TFC-MESA246-01	6 Fan Environmental Control Unit (ECU) for Remote Cabinet Sites	75016103
TFCS-MESA246-08	Extension Cable for Mesa Fan Controllers found in Mesa, 52, 192 & 384 type cabinets	75016102
TF-MC133-02	(133mm) Heat Exchanger for Mesa 768 Cabinet w/ 3 Pin Plug	
TF-MC133-05	(133mm) Heat Exchanger for Mesa Sport Cabinet w/ 3 Pin Bulkhead Plug	
TF-CSHX133-01	(133mm) HX for Cell Site Mesa Sport Cabinet w/ 4 Pin Male Weatherproof Plug	
TF-MC133-01	(133mm) Heat Exch. for Purcell FlexAir 741 Cabinet (Door) w/ 4 Leads & Fastons	
TF-MC175-04	(175mm) Heat Exchanger for Purcell A009 Cabinet w/ Weatherproof Connector	
TF-MC175-02	(175mm) Heat Exchanger for Mesa 4 NXT Cbnt (use in existing Siemens ICN 087-23500-10)	
TF-MC175-03	(175mm) Heat Exchanger for OSP Cabinet w/ 3 Pin Plug	11353804
TF-MC175-01	(175mm) HX for Siemens 914EX Metro MXU Cabinet w/ 2 Wire Open End (fan only)	11369972
TF-914EHX-01	48V Heat Exchanger for Siemens 914E RT Cabinet w/ Power Prongs	
TF-914EXMET-01	48V Fan for Siemens 914EX Metro MXU Fan Tray w/ Power Prongs	11369971
TF-OPTI-01	12V Fan for Adtran Opti 6100 Trays w/ 3 Wire Plug (use in EFANM Fan Tray # 1184508L2)	
TF-TA5KHX-02	48V "Low Profile" Heat Exchanger for Adtran TA5000 Cabinet Door w/ 4 Wire Plug	
TF-HX175LP-01	(175mm) "Low Profile" Heat Exchanger for Calix ODC Cabinet Door w/ Grommet, 4 Leads & Faston Connectors	
TF-HX220LP-01	(220mm) "Low Profile" HX for Calix ODC 1000 Cabinet w/ 4 Leads & Fastons	
TF-OPM640HX	(175mm) "Low Profile" Impeller for OPM 640 Cbnt (Retro Fit Roof) w/ 3 Wire, 4 Pin Plug	
TF-AFCHX-01	(175mm) "Low Profile" HX. for AFC Fan Unit found in OPM Cbnts w/ 2 Wire, 4 Pin	
TF-CATNHX-01	(175mm) "Low Profile" 48V HX for Catena Cabinet w/ (1) 2W & (1) 3W, 4 Pin Plug	11369997
TF-MC179-01A	Heat Exchanger for Cell Site Mesa Bridge Cabinet (Upper - Internal) w/ 4 Wire Female Weatherproof Plug	75008057
TF-MC179-01	Heat Exchanger for Cell Site Mesa Bridge Cabinet (Lower - Door) w/ 4 Wire Female Weatherproof Plug	11365933
TF-AFC672-01	48V Fan for AFC Cabinet Heat Stack w/ Power Prongs	75008791
TF-CQ250-01	(250mm) HX for Ice Qube Cabinet w/ 4 Wire Open End	
TF-CLXODC-01F	48V Heat Exchanger for Calix ODC Stack w/ 2 Wires & Fastons	
TFC-CALIX2KHX	Alarm Control Board for Calix ODC-2000 Cabinet HX Controller (alarm board only)	
TF-CLX225-01	(225mm) HX Impeller Fan (Upper) for Calix ODC Cbnt w/ 4 Wire Female Plug (14")	
TF-CLX225-02	(225mm) HX Impeller Fan (Upper) for Calix ODC Cbnt w/ 4 Wire Female Plug (30")	
TF-CLX225-03	(225mm) HX Impeller Fan (Lower) for Calix ODC Cbnt w/ 4 Wire Male Plug (30")	
TF-CLX133-01	(133mm) HX Impeller Fan (Upper/Lower) for Calix Cabinet w/ 4 Wire Plug	
TF-MCCHX-AC01	110VAC HX Blower for Reltec / McLean Cbnt w/ Pwr Plug & Adapter Plate (fan only)	75009345
TF-MCCHX-AC0R	110VAC (Right) HX Blower for Reltec/McLean Cbnt w/ Power Plug & Plate (fan only)	
TF-TX33HX-01	(175mm) HX for Mclean ClimaGuard Cabinet Cooler w/ 4 Wire Weatherproof Conn.	
TF-TX38HX-01	(225mm) HX for Mclean ClimaGuard Cabinet Cooler w/ 4 Wire Weatherproof Conn.	
TF-MC225-01A	(225mm) Heat Exchanger for Cell Site Emerson Mesa XL Cabinet Door	11329002
TFC-MESA-01	2 Port Mesa Cabinet ECU (used in Cell Sites: XL, SOLE, Span XL, Bridge, Edge & Sport)	
TF-MC225-01	(225mm) Heat Exchanger for Mesa Cabinet (Top) w/ Round Weatherproof Plug	11327076
TF-MC225-02	(225mm) Heat Exchanger for Mesa Cabinet (Bottom) w/ 4 Wire Plug	11327077
TF-MC225-02-KIT	(225mm) Heat Exch. KIT for Mesa Cabinet (Bottom) w/ 4 Wire Plug & Mtg Bracket	11328045

**Don't see the fan you are looking for? Send us a sample & we will find a match!
PLEASE CALL: 856-753-8585 or EMAIL: custsvcs@tagcords.com**

TAG DMS-100 3X9013 Universal Fan Tray

TFT-3X9013T

Universal 48VDC Fan Tray

- **No 24VAC Inverters**
(24VAC inverters cause heat concerns & major equipment failures)
- **No Mechanical Sensors**
(sensor paddles are known to bend & break)

INSTALLATION VIDEOS:



NT3X90AA/AB



NT3X90AC



NT3X90AF

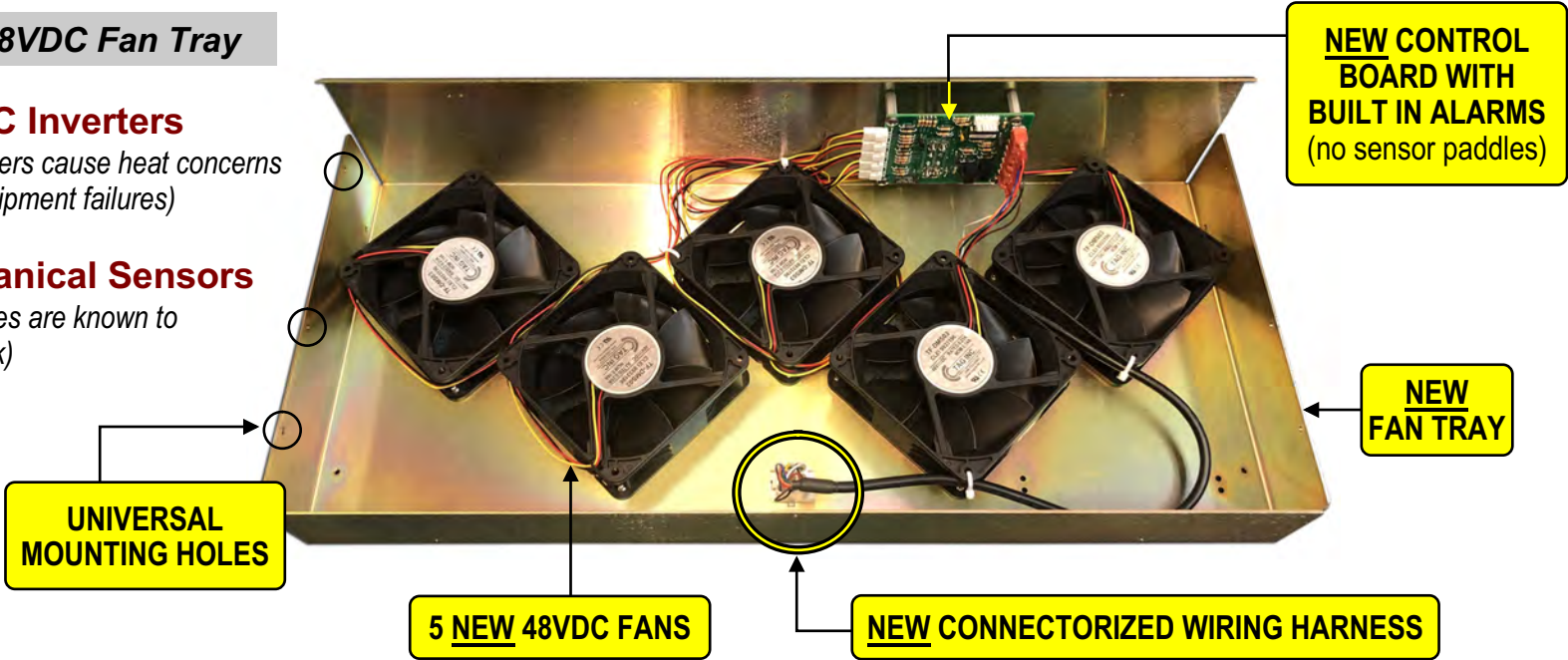

- **Connectorized Universal metal tray with Fan Alarm Board** *(no sensor paddles)*
- **Pre-assembled & works with NT3X90AA, NT3X90AB, NT3X90AC & NT3X90AF Cooling Units**
- **Adapter cables* are supplied for NT3X90AA/AB & NT3X90AF Cooling Units**
**(adapter cables are not used with NT3X90AC)*

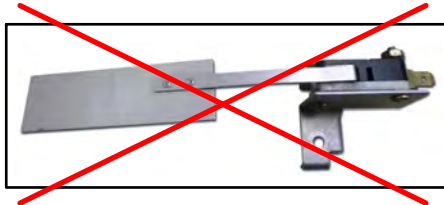

Ordering Information:

TFT-3X9013T

TAG Universal DMS-100 3X9013 Fan Tray

- Includes: (1) Brand New Fan Tray w/ Universal Mounting Holes,
 (5) TF-DMS03, 48VDC Fans w/ TTL Tach & 3 Wire Plug,
 (1) Fan Control Board w/ Built in Sensors (no paddles needed), Wiring Labels, Mounting Hardware,
 (1) Wiring Harness w/ Connector, NT3X90AA/AB & NT3X90AF Adapter Cables & Installation Guide

VZ ID # 7501 3628

VZB ID # 1095 9500

150 Cooper Rd. (F-15)
W. Berlin, NJ 08091

www.tagcords.com
Telecom Assistance Group

Telephone: (856) 753-8585
Fax: (856) 768-7645