

Windstream - Winbuy 2025 Product Ordering Guide

Issue 1.0

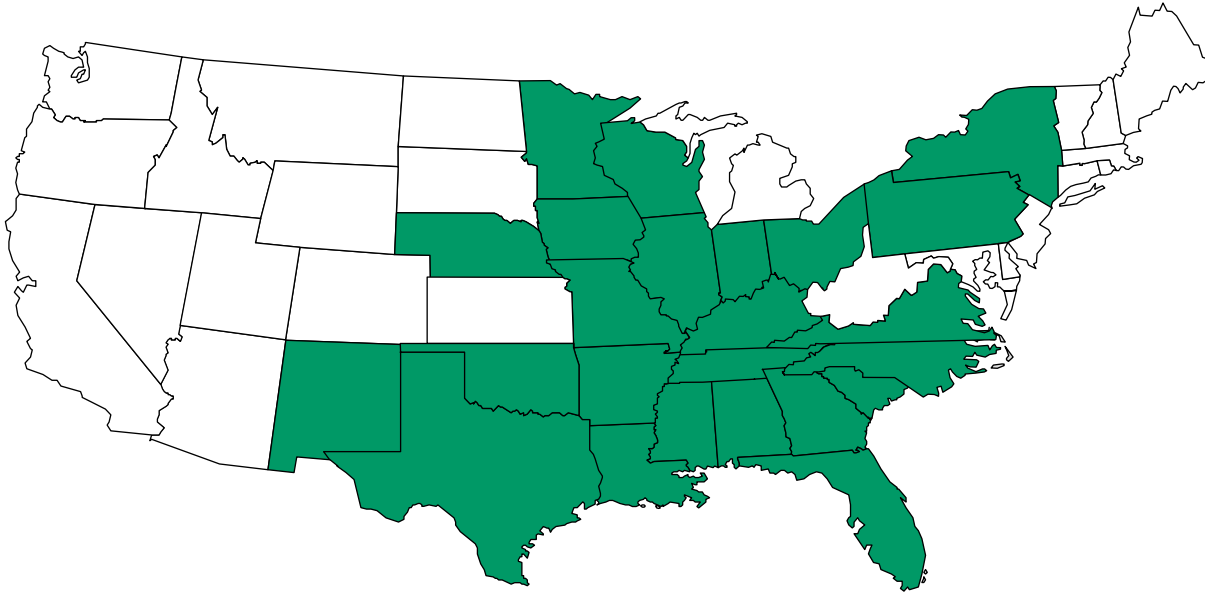

Provided By:



The "Cord Company" and more . . .

"TEST CORDS & ADAPTERS"

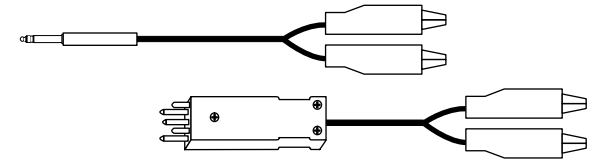

"TEST BOARDS & STREAKER CARDS"

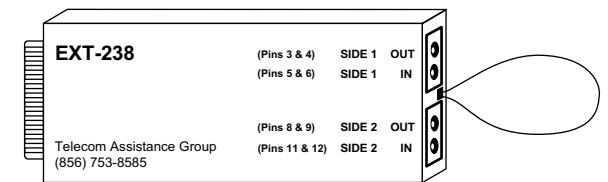

"FIBER OPTIC CORDS, COUPLERS & STREAKERS"

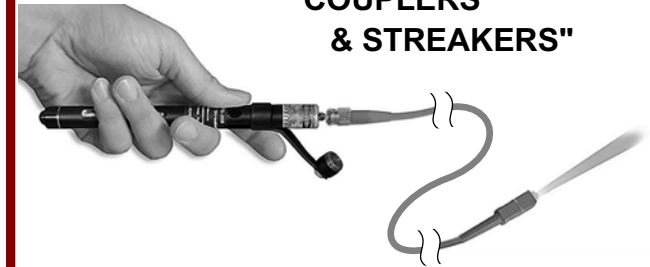

"SWITCH TERMINALS"

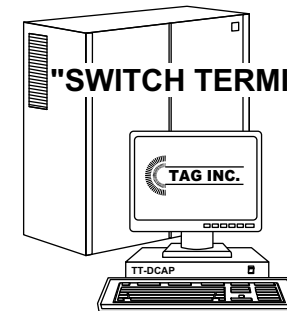

"FANS"

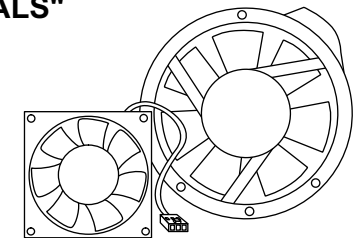

www.tagcords.com

-

856-753-8585

TAG DMS-100 3X9013 Universal Fan Tray

TFT3X9013T

Universal 48VDC Fan Tray

- **No 24VAC Inverters**
(24VAC inverters cause heat concerns & major equipment failures)
- **No Mechanical Sensors**
(sensor paddles are known to bend & break)

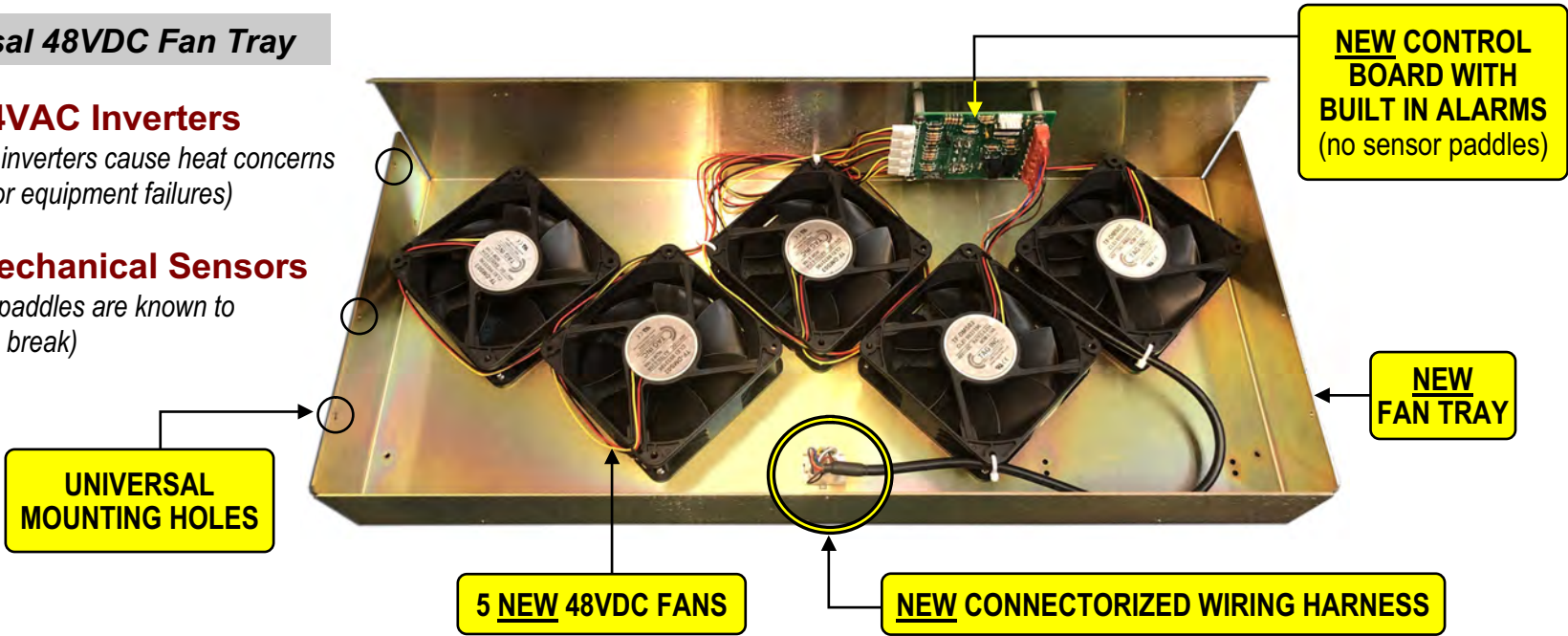

- **Connectorized** Universal metal tray with Fan Alarm Board *(no sensor paddles)*
- Pre-assembled & works with NT3X90AA, NT3X90AB, NT3X90AC & NT3X90AF Cooling Units
- Adapter cables* are supplied for NT3X90AA/AB & NT3X90AF Cooling Units
**(adapter cables are not used with NT3X90AC)*

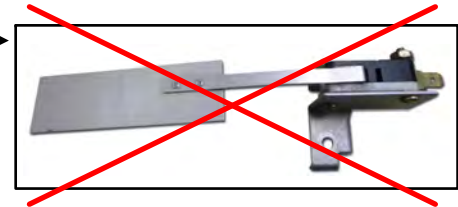

Ordering Information:

TAG Universal DMS-100 3X9013 Fan Tray

Includes: (1) Brand New Fan Tray w/ Universal Mounting Holes, (5) TF-DMS03, 48VDC Fans w/ TTL Tach & 3 Wire Plug,
 (1) Fan Control Board w/ Built in Sensors (no paddles needed), Wiring Labels, Mounting Hardware,
 (1) Wiring Harness w/ Connector, NT3X90AA/AB & NT3X90AF Adapter Cables & Installation Guide



WINBUY #
TFT3X9013T

150 Cooper Rd. (F-15)
 W. Berlin, NJ 08091

www.tagcords.com
Telecom Assistance Group

Telephone: (856) 753-8585
 Fax : (856) 768-7645

WINDSTREAM

FEATURES / APPLICATION	WINBUY #	LENGTH	DESCRIPTION
<p>SC to SC, Singlemode Duplex, 2.0mm yellow, UPC</p> <ul style="list-style-type: none"> SINGLEMODE: Link between bulkhead adapters and terminal equipment 	<p>400766DM05 400766DM10</p>	<p>(5 mtrs) (10 mtrs)</p>	<p>SC to SC, SINGLEMODE DUPLEX, UPC TEST CORD</p> 
<p>SC to ST, Singlemode Duplex, 2.0mm yellow, UPC</p> <ul style="list-style-type: none"> SINGLEMODE: Link between bulkhead adapters and terminal equipment 	<p>400771DM05 400771DM10</p>	<p>(5 mtrs) (10 mtrs)</p>	<p>SC to ST, SINGLEMODE DUPLEX, UPC TEST CORD</p> 
<p>SC to SC, OSP Singlemode Simplex, 2.0mm yellow, APC</p> <ul style="list-style-type: none"> SINGLEMODE: Link between bulkhead adapters and terminal equipment 	<p>400766AA0SP01</p>	<p>(1 ft)</p>	<p>SC to SC, SINGLEMODE SIMPLEX, APC TEST CORD</p> 

DB9M / RS232 to USB Adapter Cable

Need access to a Serial Port on your Laptop?

TAG's Adapter Cable will convert your Laptop's USB Port into a Serial Port!

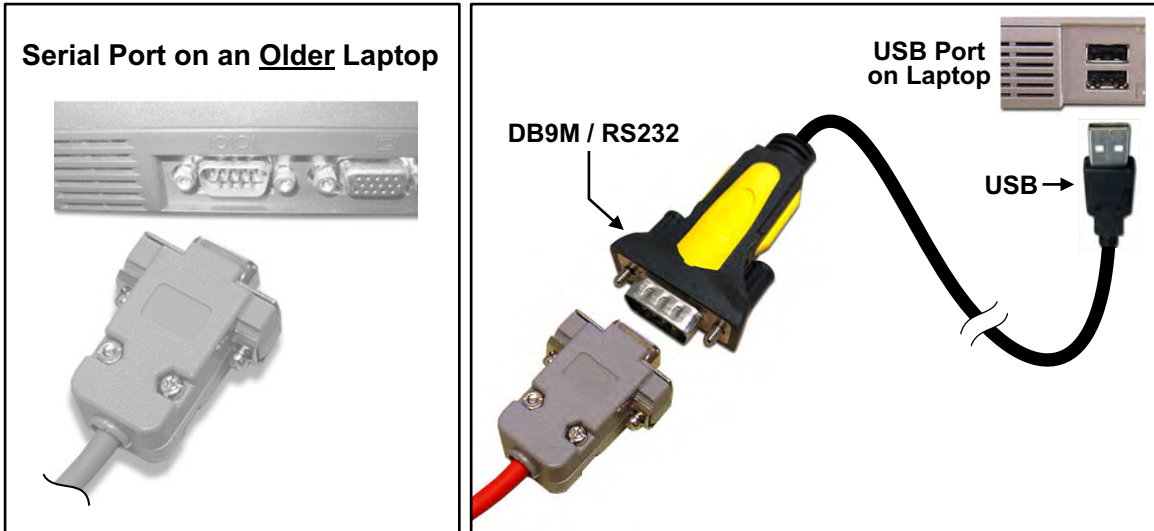

System Requirements:

- Supports Windows® 2000 / XP / Server 2008 / Vista / 7 / 8 / 10
- Available USB Port

Application:

Plug the USB connector into your computer and the serial connector into your serial device to exchange files, data and more.



Ordering Information:

DB9M/RS232 to USB Adapter Cable

Supports Windows® 2000 / XP / Server 2008 / Vista / 7 / 8 / 10

**WINBUY #
400720USB**

150 Cooper Rd. (F-15)
W. Berlin, NJ 08091

www.tagcords.com

Telecom Assistance Group

Telephone: (856) 753-8585

Fax: (856) 768-7645

Business Class Network Interface Device (NID)

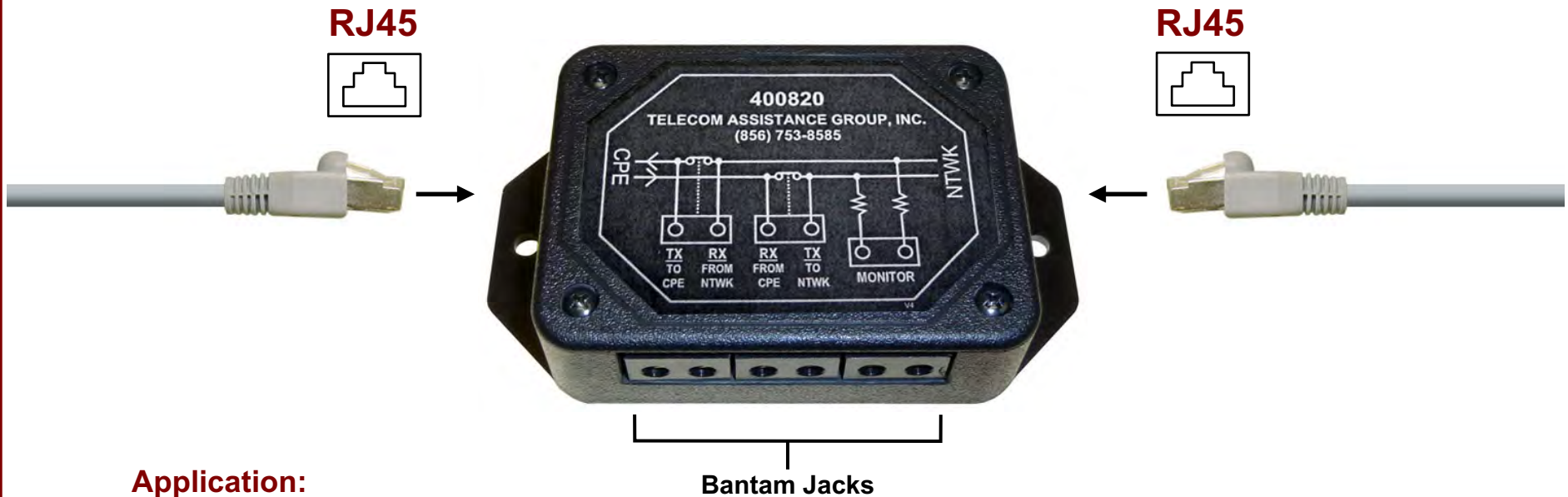

Application:

- ▶ One unit per T1 is required and is installed between the VGW and the customer PBX by the Business Class provider.
- ▶ The 400820 (NID) provides an input (Network) RJ45 port to connect the VGW to the NID. *The Business Class provider will be responsible for providing the connection from the VGW to the 400820 (NID).*
- ▶ An RJ45 port (CPE) provides Business Class customers a connection from PRI and the CPE PBX. *This connection is the customer's responsibility.*
- ▶ Bantam test ports are located on the bottom of the 400820 (NID) for future maintenance and performance testing connected to the preferred test set.



Ordering Information:
T1 Monitor Box

WINBUY #
400820

150 Cooper Rd. (F-15)
 W. Berlin, NJ 08091

www.tagcords.com
Telecom Assistance Group

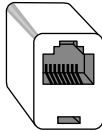
Telephone: (856) 753-8585
 Fax : (856) 768-7645

FEATURES / APPLICATION	WINBUY #	DESCRIPTION
<p>Cat 5 Cable (RJ45 to RJ45)</p> <ul style="list-style-type: none"> Standard CAT5 Cable 	<p>RHCAT505 RHCAT510 RHCAT515 RHCAT520 RHCAT525 RHCAT530 RHCAT540 RHCAT550</p>	<p style="text-align: center;"><u>LENGTH</u></p> <p style="text-align: center;">(5') (10') (15') (20') (25') (30') (40') (50')</p> <p>CAT 5 CABLES (RJ45 to RJ45) (@ various lengths)</p> 
<p>RJ45/48 Coupler</p> <ul style="list-style-type: none"> General purpose coupler adapter 	<p>RJ48C</p>	<p>RJ45/48 COUPLER</p> 
<p>DMX Provisioning (CAT5E) Cross-Over Cable, (10')</p> <ul style="list-style-type: none"> Cable for testing Lucent's DMX Platforms with the CAT5E Ethernet Cable. The CAT5E cable is designed to work with Windows XP operating systems. 	<p>400448XP10</p>	<p>DMX CROSS-OVER CABLE</p> 
<p>RJ45/48 to DB 9 Pin (male), (6')</p> <ul style="list-style-type: none"> RJ45 to DB 9 Pin (male) typically used for provisioning 	<p>RHCU720M</p>	<p>RJ45/48 to 9 PIN (male)</p> 

Remote Network Cable Tester w/ Tone Generator

CAT107G

Simplify Network Cable Testing !!

Cable Test Features:

- Displays:**
- Short
 - Reversed
 - Miswired
 - Split Pairs

Tone Generator* Features:

- Verification of Shield Integrity
- Puts Tracer Tone on Cable

* Tone Generator function requires customer supplied Cable Tracing Probe

Additional Features:

- Specially designed Remote Unit that enables one person to test installed cables
- Easy to read Fault Display and high speed testing
- Debug mode for detailed fault identification results
- Auto Sleep Mode and Power Off Switch to decrease power consumption
- Low Battery Indicator
- Includes (4) four AAA batteries

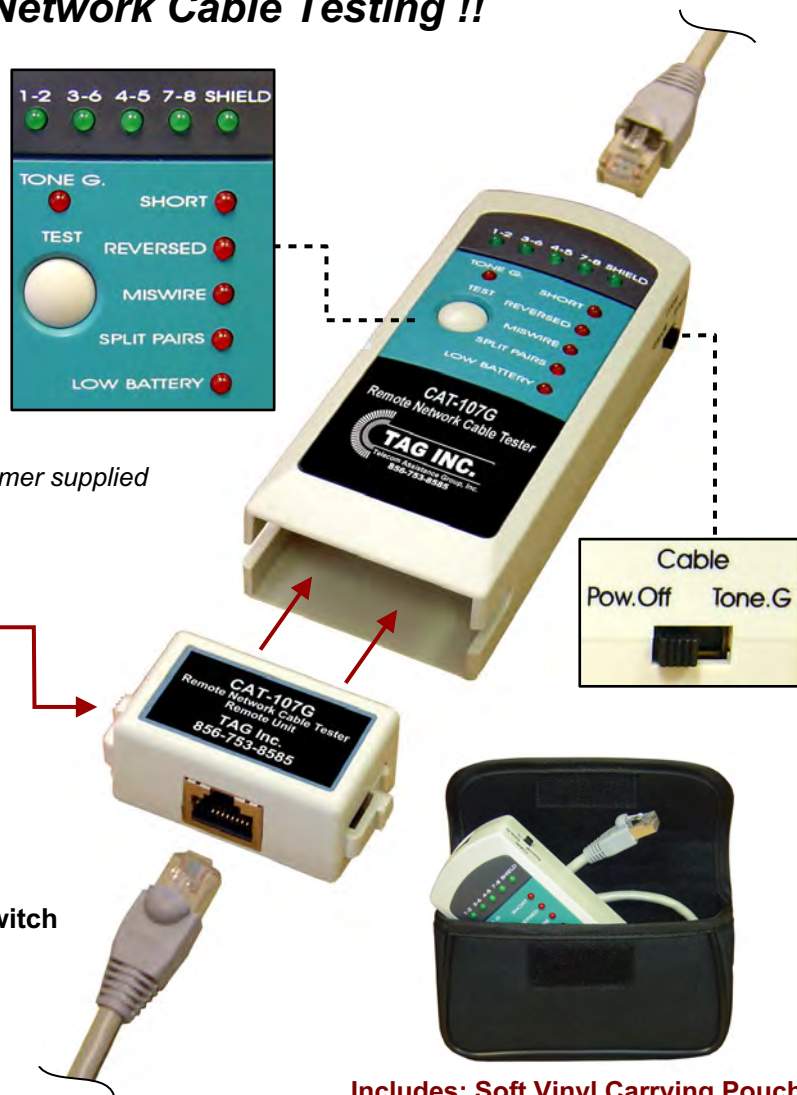

Includes: Soft Vinyl Carrying Pouch & Remote Terminating Cable

Application:

The CAT107G is a small hand-held cable tester, which enables network professionals to quickly and easily verify the integrity of ethernet twisted pair cables for open pairs, shorted pairs, reversed pairs, crossed pairs and split pairs. Push the TEST button and the CAT107G will automatically scan for any existing faults in your cable. The specially designed remote terminator is provided for one-person testing of installed cables. The tone generator function can be used to send a signal through installed cables which can be traced with most cable tracers on the market.

Ordering Information:

Remote Network Cable Tester w/ Tone Generator

includes: (1) Carrying Pouch, (1) Remote Terminating Cable & (4) AAA Batteries

WINBUY

CAT107G





150 Cooper Rd. (F-15)
W. Berlin, NJ 08091





www.tagcords.com

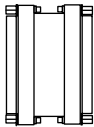

Telecom Assistance Group

Telephone: (856) 753-8585

Fax : (856) 768-7645

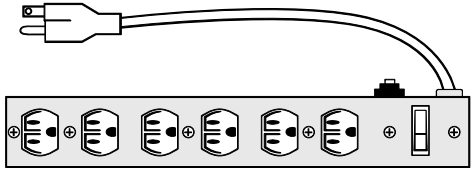
FEATURES / APPLICATION	WINBUY #	DESCRIPTION
<p>DB 9 Pin (male) to DB 25 Pin (female), (6')</p> <ul style="list-style-type: none"> 9 Pin to 25 Pin conversion cable 	400725	<p>9 PIN (male) to 25 PIN (female)</p> 
<p>DB 9 Pin (male) to DB 9 Pin (female), (6')</p> <ul style="list-style-type: none"> Commonly used from Laptop to test at Pair Gain (HDSL) Wired straight 	400720	<p>9 PIN (male) to 9 PIN (female)</p> 
<p>DB 25 Pin (male) to DB 25 Pin (female), (6')</p> <ul style="list-style-type: none"> Standard Serial Printer Cable, (25 Wires) 	400706	<p>25 PIN (male) to 25 PIN (female)</p> 
<p>DB 9 Pin (female) to 25 Pin (male), (6')</p> <ul style="list-style-type: none"> IBM AT COM1 Computer Cable 	400703	<p>9 PIN (female) to 25 PIN (male)</p> 
<p>HDSL Provisioning Test Cord</p> <ul style="list-style-type: none"> DB 25 Pin (male) to DB 9 Pin (male) for HDSL provisioning from "Dumb" terminals 	400703H10 (10') 400703H25 (25')	<p>HDSL PROVISIONING TEST CORD</p> 

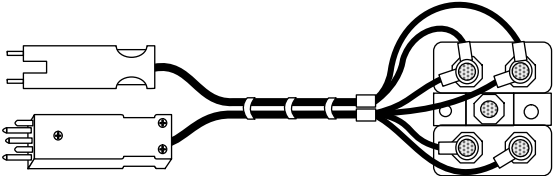
FEATURES / APPLICATION	WINBUY #	DESCRIPTION
<p>DB 25 Pin (male) to (male) Gender Changer</p> <ul style="list-style-type: none"> Standard Serial Gender Changer 	400701	<p>25 PIN (male) to 25 PIN (male) GENDER CHANGER</p> 
<p>DB 9 Pin (male) to DB 9 Pin (male) Adapter</p> <ul style="list-style-type: none"> 9 Pin Adapter - Gender Changer 	400709M	<p>9 PIN (male) to 9 PIN (male) ADAPTER</p> 
<p>DB 9 Pin (female) to DB 9 Pin (female) Gender Changer</p> <ul style="list-style-type: none"> 9 Pin Adapter - Gender Changer 	400709F	<p>9 PIN (female) to 9 PIN (female) GENDER CHANGER</p> 
<p>DB 9 Pin (male) to DB 9 Pin (female) "Null Adapter"</p> <ul style="list-style-type: none"> Null Adapter 	400709N	<p>9 PIN (male) to 9 PIN (female) "NULL" ADAPTER</p> 
<p>UL Surge Suppressor Outlet Power Strip</p> <ul style="list-style-type: none"> 6 outlets with 15A breakout 	400704	<p>SURGE SUPPRESSOR - OUTLET POWER STRIP</p> 

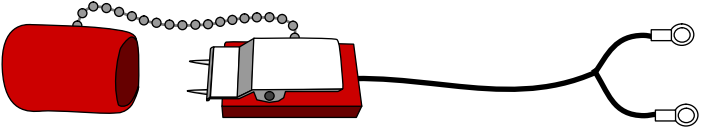
FEATURES / APPLICATION	WINBUY #	DESCRIPTION
<p>Protector/526A plug to 125 Station Protector, (10')</p> <ul style="list-style-type: none"> Cabinet mounting assembly for performing line tests on SLC-96 & Series 5 	<p>T6W3F10</p>	<p>PROTECTOR/526A to STATION PROTECTOR</p> 
<p>Wire Wraps to Mini Alligator Clips, (4')</p> <ul style="list-style-type: none"> Slides on wire wraps Alligator Clip connections to butt sets, Caller ID, etc. 	<p>400200MA04</p>	<p>WIRE WRAPS to MINI ALLIGATOR CLIPS</p> 
<p>RJ48 to 6P Alligator Clips, (6')</p> <ul style="list-style-type: none"> Test cord used from TPI (ISDN) test set (RJ48 - ISDN) to Alligator Clips Pin 4 - Ring/Pin 5 - Tip (RJ48) 	<p>400448AP2</p>	<p>RJ48 to 6P ALLIGATOR CLIPS</p> 
<p>RLS Plug to Round Lugs, (8')</p> <ul style="list-style-type: none"> Used for testing Reltec Systems 	<p>400196KIT2</p>	<p>RLS PLUG to ROUND LUGS</p> 

The "Multi" Cord

Butt-In Connectors

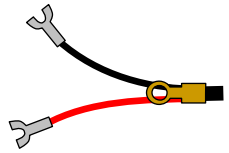

1 **Hardwire**
(Standard)

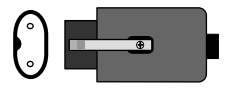

2 **471A Jack**
(Quick Disconnect)

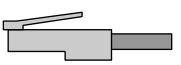

3 **Modular**
3A.) 4 Position, 2 conductor
3B.) 6 Position, 2 conductor
3C.) 8 Position, 2 conductor



4 **Hardwire**
(Weatherproof)

ORDERING SAMPLE









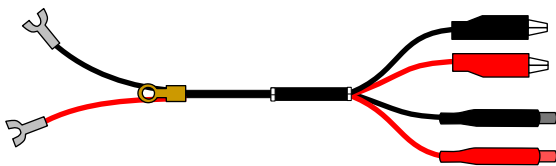

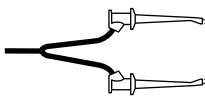
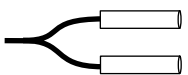
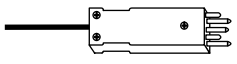
Butt-In	Plugs			Length
1	A	C	-	6

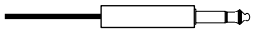
Choose (1 to 4 Ends)

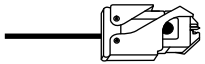
WINBUY # 1AC6

Hardwire to Alligators / Wire Wraps, (6')

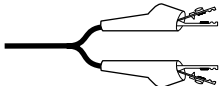
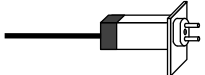
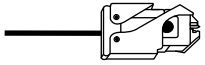

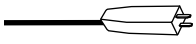
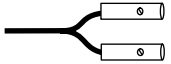
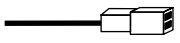
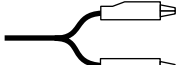
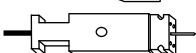
Alligator	A	
Mini Test	B	
Wire Wrap	C	
Protector	D	
453A	E	
Bantam	F	
310	G	
526A	H	
88 Type (D Clip)	I	
526P (Porta)	J	
Snagless RJ11	K	
SLC 96	L	
Modular (RJ11)	M	
6P Alligator	O	
310 MDF	P	
110 Clip (C Clip)	Q	
76 Clip	R	
SLC 5	S	
360 Tools	T	
66 Blk Adapter	X	
Mini Alligator	Y	
Porta	Z	





150 Cooper Rd. (F-15)
W. Berlin, NJ 08091





www.tagcords.com





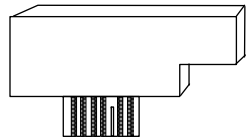

Telecom Assistance Group

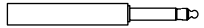

Telephone: (856) 753-8585

Fax : (856) 768-7645



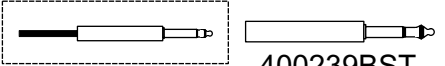

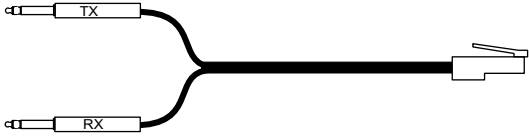
FEATURES / APPLICATION	WINBUY #	DESCRIPTION
<p>526A plug to Alligator Clips, (6')</p> <ul style="list-style-type: none"> Monitor access to Protectors via test points without pulling Protector Equivalent to P2FL 	400526A	<p>526A PLUG to ALLIGATOR CLIPS</p> 
<p>453A plug to Alligator Clips, (3')</p> <ul style="list-style-type: none"> Used to short the tip and ring or to ground the tip and/or ring Plugs to recessed terminals on 300 series connectors (except 310) Equivalent to P2EF 	400430	<p>453A PLUG to ALLIGATOR CLIPS</p> 
<p>Dual Push Pins (310 MDF) to Alligator Clips, (3')</p> <ul style="list-style-type: none"> Used to short the tip and ring or to ground the tip and/or ring Plugs to recessed terminals on 310 series connectors Equivalent to P2FM 	400426	<p>DUAL PUSH PINS to ALLIGATOR CLIPS</p> 
<p>Protector (non-bridging) to Alligator Clips, (8')</p> <ul style="list-style-type: none"> Test access at coils 	400300S	<p>PROTECTOR to ALLIGATOR CLIPS</p> 
<p>Protector to Alligator Clips, (3')</p> <ul style="list-style-type: none"> Test access at MDF (coils) 	400300C3	<p>PROTECTOR to ALLIGATOR CLIPS</p> 

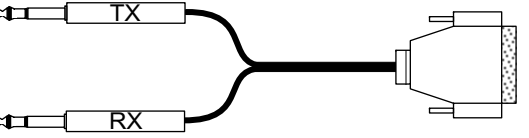
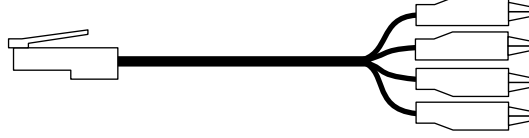

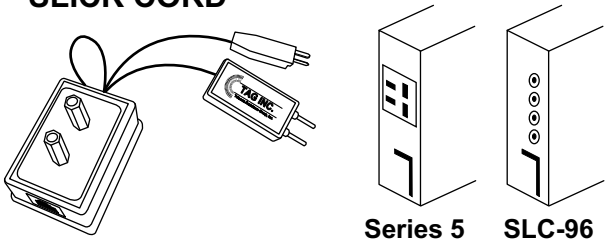
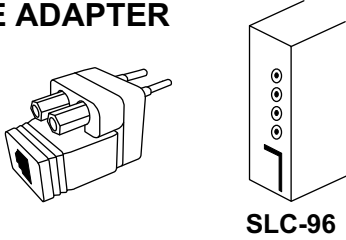
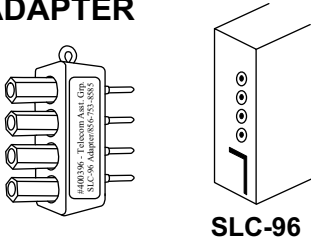
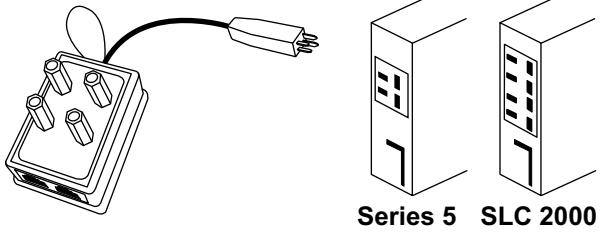
FEATURES / APPLICATION	WINBUY #	DESCRIPTION
<p>Bantam Looping Plug</p> <ul style="list-style-type: none"> 3 conductor looping plug 	400210LP	<p>BANTAM LOOPING PLUG</p> <div style="text-align: center; margin-top: 10px;">  </div>
<p>MDF Shorting cord</p> <ul style="list-style-type: none"> 453A plug looped Used at 303, 304, and 308 MDF frames 	400430L	<p>MDF SHORTING CORD</p> <div style="text-align: center; margin-top: 10px;">  </div>
<p>SLC-96 Looping Plug</p> <ul style="list-style-type: none"> Loops SLC-96 circuits at the LIU 	400396L	<p>SLC 96 LOOPING PLUG</p> <div style="text-align: center; margin-top: 10px;">  </div>
<p>15 Pin (female) to LIU "low profile" connector, (8')</p> <ul style="list-style-type: none"> Connects Power Panel to LIU for test jack access "Low Profile" allows greater door clearance at SLC cabinets 	400442FL	<p>15 PIN to LIU</p> <div style="text-align: center; margin-top: 10px;">  </div>
<p>Bantam Terminating Plug</p> <ul style="list-style-type: none"> 100 ohm Terminating Plug 	B004210TP100	<p>BANTAM TERMINATING PLUG</p> <div style="text-align: center; margin-top: 10px;">  </div>

FEATURES / APPLICATION	WINBUY #	DESCRIPTION
<p>Bantam to Bantam, (6') (RED) Bantam to Bantam, (6') (BLACK)</p> <ul style="list-style-type: none"> Patching or Test Set Application Red / Black colors for Transmit / Receive 	<p>400210RD06 400210BK06</p>	<p>BANTAM to BANTAM - RED BANTAM to BANTAM - BLACK</p> 
<p>Dual Bantam to Dual Bantam, (10') Dual Bantam to Dual Bantam, (20') Dual Bantam to Dual Bantam, (42')</p> <ul style="list-style-type: none"> Patch cord 	<p>400210DD10 400210DD20 400210DD42</p>	<p>DUAL BANTAM to DUAL BANTAM</p> 
<p>Dual Bantam to Mini Test Clips, (6')</p> <ul style="list-style-type: none"> "Mini Grabbers" excellent for access to various connectors, wire terminals 	<p>400210DT</p>	<p>DUAL BANTAM to MINI TEST CLIPS</p> 
<p>Bantam to Mini Test Clips, (6')</p> <ul style="list-style-type: none"> "Mini Grabbers" excellent for access to various connectors, wire terminals 	<p>400210TTELE</p>	<p>BANTAM to MINI TEST CLIPS</p> 
<p>Bantam to Wire Wrap Terminals, (6')</p> <ul style="list-style-type: none"> Slides on standard CO terminal block pins (.045) for test access 	<p>400210WP</p>	<p>BANTAM to WIRE WRAP TERMINALS</p> 
<p>Bantam to (2) Alligator Clips, (6')</p> <ul style="list-style-type: none"> Access to various connectors, bare cable 	<p>400210A</p>	<p>BANTAM to ALLIGATOR CLIPS</p> 
<p>Bantam to 310 Conversion Plug</p> <ul style="list-style-type: none"> Slides over bantam plug converting it to a 310 	<p>400239BST</p>	<p>BANTAM TO 310 CONVERSION PLUG</p>  <p style="text-align: center;">BANTAM 400239BST</p>

FEATURES / APPLICATION	WINBUY #	DESCRIPTION
<p>Bantam "Y" (Tx & Rx) to RJ48C- (T1), (8')</p> <ul style="list-style-type: none"> Commonly used to Transmit (TX) and Receive (RX) from T1 tests The RJ48C plugs into the faceplate of T1 cards allowing test access 	40024808	<p>BANTAM "Y" to RJ48C, (8')</p>  <p>The diagram shows a cable with two Bantam Y connectors on one end, labeled TX and RX, and a single RJ48C connector on the other end.</p>
<p>Bantam "Y" (Tx & Rx) to RJ48S - (DDS), (8')</p> <ul style="list-style-type: none"> Commonly used to Transmit (TX) and Receive (RX) from DDS tests The RJ48S plugs into the faceplate of DDS cards allowing test access 	400248S	<p>BANTAM "Y" to RJ48S, (8')</p>  <p>The diagram shows a cable with two Bantam Y connectors on one end, labeled TX and RX, and a single RJ48S connector on the other end.</p>
<p>310 "Y" (Tx & Rx) to 15 Pin D (male), (4')</p> <ul style="list-style-type: none"> 3101596 Commonly used to Transmit (TX) and Receive (RX) from Customer Service Unit (CSU) from T1 test sets Also used with T1 power lids 	400315M04	<p>310 "Y" to 15 PIN D (male), (4')</p>  <p>The diagram shows a cable with two Bantam Y connectors on one end, labeled TX and RX, and a 15-pin D-sub connector on the other end.</p>
<p>RJ48 (T1) to 4 Alligator Clips, (6')</p> <ul style="list-style-type: none"> 597243 Alligator Clip Access to RJ48 (Pins 1,2,4,5) 	400448A406	<p>RJ48 (T1) to 4 ALLIGATOR CLIPS, (6')</p>  <p>The diagram shows a cable with a single RJ48 connector on one end and four alligator clips on the other end.</p>

FEATURES / APPLICATION	WINBUY #	DESCRIPTION
<p>"The SLICK CORD", (2')</p> <ul style="list-style-type: none"> Dual Purpose cord for Series 5/SLC 2000 and/or SLC-96/DISC*S faceplate access 	4003956	<p>"SLICK CORD"</p> 
<p>SLC-96 Line Adapter</p> <ul style="list-style-type: none"> Hollow post and/or modular access to Odd/Even Channels at faceplate of SLC-96/DISC*S 	4003962M	<p>SLC-96 LINE ADAPTER</p> 
<p>SLC-96 Line Adapter</p> <ul style="list-style-type: none"> Hollow post access to Odd/Even Channels at faceplate of SLC-96/DISC*S channel units 	400396	<p>SLC-96 LINE ADAPTER</p> 
<p>SLC Series 5 Test Cord, (3')</p> <ul style="list-style-type: none"> Hollow post (Alligator Clip access) and/or modular (RJ11) access to Odd/Even channels Dial tone access at faceplate of Series 5 or SLC 2000 	400395	<p>SLC SERIES 5 TEST CORD</p> 

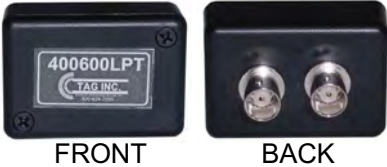
FEATURES / APPLICATION	WINBUY #	DESCRIPTION
<p>440A to 440A, (6') - Black 440A to 440A, (6') - Red</p> <ul style="list-style-type: none"> Coax Patch / Test Cord Available in various lengths 	<p>400440ABK 400440ARD</p>	<p>440A to 440A</p> 
<p>440A to BNC, (6') - Black 440A to BNC, (6') - Red</p> <ul style="list-style-type: none"> Coax Test Cord Available in various lengths 	<p>400440BBK 400440BRD</p>	<p>440A to BNC</p> 
<p>440A to 358A, (12')</p> <ul style="list-style-type: none"> Coax Patch / Test Cord Available in various lengths 	<p>B40358A12</p>	<p>440A to 358A</p> 
<p>358A to 358A, (12')</p> <ul style="list-style-type: none"> Coax Patch / Test Cord Available in various lengths 	<p>B00358A12</p>	<p>358A to 358A</p> 
<p>358A to BNC, (12')</p> <ul style="list-style-type: none"> Coax Test Cord Available in various lengths 	<p>B00358B12</p>	<p>358A to BNC</p> 

FEATURES / APPLICATION	WINBUY #	DESCRIPTION
<p>BNC Loopback Cord, (9")</p> <ul style="list-style-type: none"> Coax Test Cord Available in various lengths 	<p>400440BLP</p>	<p>BNC LOOPBACK CORD</p> 
<p>Dual BNC Coax Loopback Tool</p> <ul style="list-style-type: none"> Used to verify Dual BNC Coax cabling 	<p>400600LPT</p>	<p>DUAL BNC COAX LOOPBACK TOOL</p> 
<p>358A Coax Loopback Tool</p> <ul style="list-style-type: none"> Used to verify 358A Coax cabling 	<p>400358LPT</p>	<p>358A COAX LOOPBACK TOOL</p> 
<p>Dual 440D Coax Loopback Tool</p> <ul style="list-style-type: none"> Used to verify Dual 440D Coax cabling 	<p>400440LPT</p>	<p>DUAL 440D COAX LOOPBACK TOOL (Female)</p> 

COAX PATCH CORDS

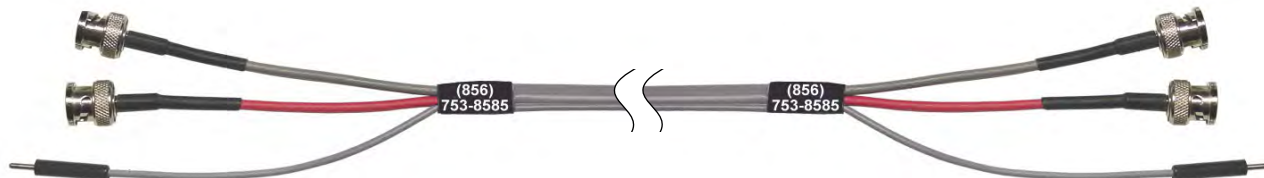

Ordering Information:

	<u>WINBUY #</u>
Dual BNC to Dual BNC w/ tracer, (5')	400440BB05
Dual BNC to Dual BNC w/ tracer, (10')	400440BB10
Dual BNC to Dual BNC w/ tracer, (15')	400440BB15
Dual BNC to Dual BNC w/ tracer, (20')	400440BB20
Dual BNC to Dual BNC w/ tracer, (25')	400440BB25
Dual BNC to Dual BNC w/ tracer, (30')	400440BB30
Dual BNC to Dual BNC w/ tracer, (35')	400440BB35
Dual BNC to Dual BNC w/ tracer, (40')	400440BB40
Dual BNC to Dual BNC w/ tracer, (45')	400440BB45

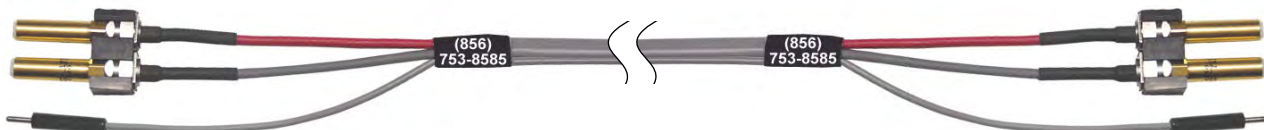

Ordering Information:

	<u>WINBUY #</u>
Dual 440D to Dual 440D w/ tracer, (5')	400440DD05
Dual 440D to Dual 440D w/ tracer, (10')	400440DD10
Dual 440D to Dual 440D w/ tracer, (15')	400440DD15
Dual 440D to Dual 440D w/ tracer, (20')	400440DD20
Dual 440D to Dual 440D w/ tracer, (25')	400440DD25
Dual 440D to Dual 440D w/ tracer, (30')	400440DD30
Dual 440D to Dual 440D w/ tracer, (40')	400440DD40
Dual 440D to Dual 440D w/ tracer, (50')	400440DD50

150 Cooper Rd. (F-15)
W. Berlin, NJ 08091

www.tagcords.com

Telecom Assistance Group

Telephone: (856) 753-8585

Fax: (856) 768-7645

ADSL Test Cord

400548ADSL

Protector to RJ48 "Y" - 6' (ADSL)

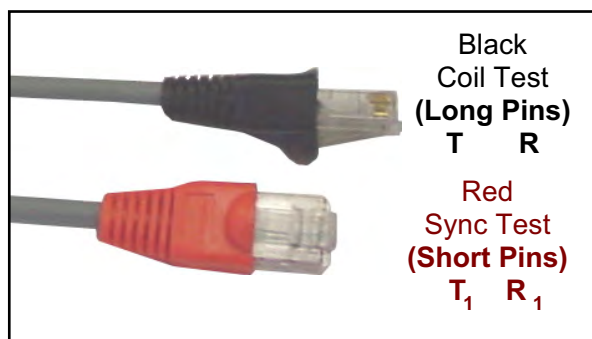
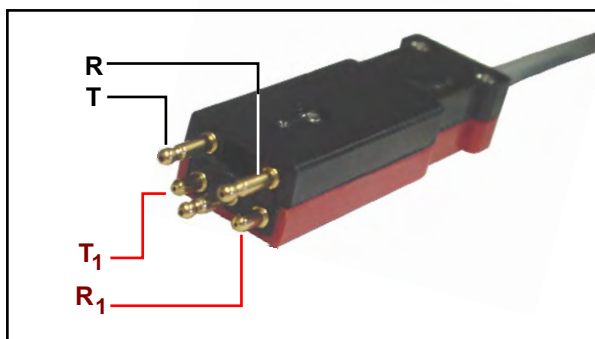

WIRING NOTES:

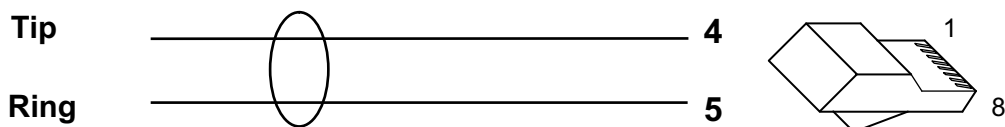

Application:

Used with Sunrise ADSL Test Set.
 Plug Red RJ48 in test set to perform Sync Test.
 Plug Black RJ48 in test set to perform Coil Test.

<p>Ordering Information: ADSL Test Cord, (6')</p>	<p>WINBUY # 400548ADSL</p>
-------------------------------------------------------------------------------	--------------------------------------------------------

150 Cooper Rd. (F-15)
 W. Berlin, NJ 08091

www.tagcords.com

Telephone: (856) 753-8585
 Fax : (856) 768-7645

Telecom Assistance Group

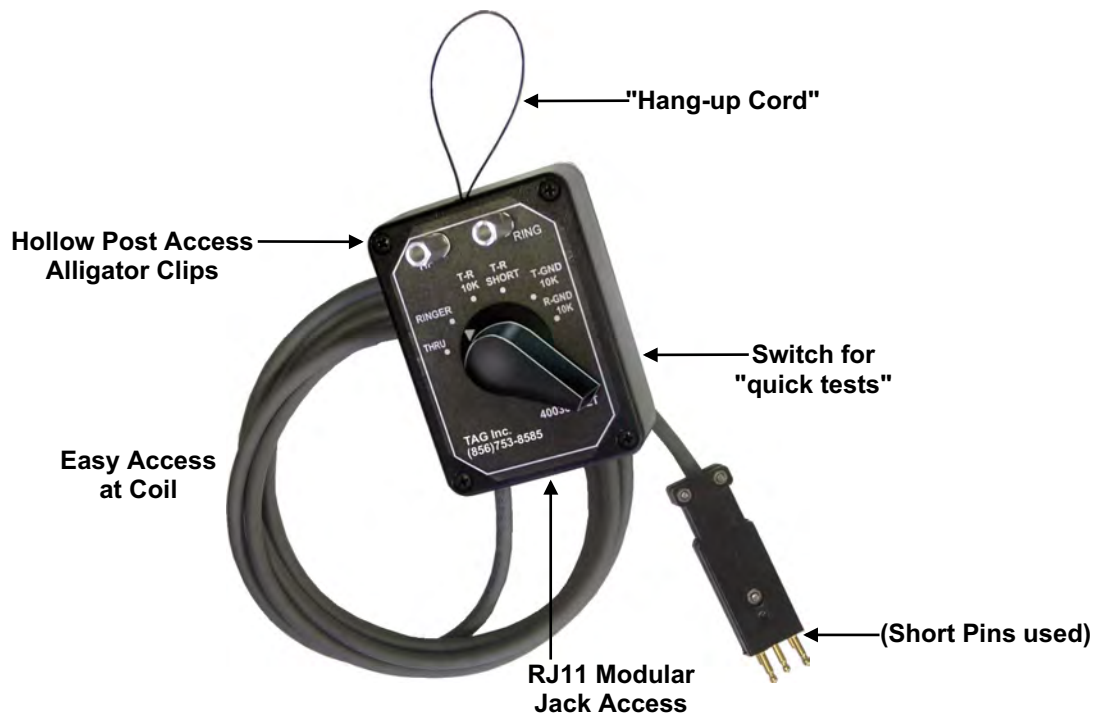
MLT Load / Test Box**400300MLT**

TAG's MLT Load/Test Box (400300MLT) provides a convenient and easy means to **Test** with **MLT** on **New Installs** and **Calibrate "Loop Resistance"**.

Simply plug the MLT Load/Test Box on the circuit to test with MLT. Establish communication with a MLT tester to verify results.

Note: TAG offers a "Hands Free" Telephone Set - Model WT-1K for added convenience. A sturdy switch on the MLT Load/Test Box allows selecting the following tests:

- Tip to Ring Short
- Ring to Ground (10K)
- Tip to Ring Load (10K)
- Ringer Test Load (>.75A)
- Tip to Ground (10K)
- Thru to Hollow Posts and RJ11 (just in case)

The MLT Load/Test Box plugs to various interface points for ease of testing with MLT. The 400300MLT can be equipped with "coil access" at the RT, RJ11 access at the NID or Alligator Clips for general purpose.

Ordering Information:**Cord Protector MLT Test Box, (6')****WINBUY #****400300MLT**

150 Cooper Rd. (F-15)
W. Berlin, NJ 08091

www.tagcords.com

Telephone: (856) 753-8585
Fax : (856) 768-7645

Telecom Assistance Group

HST-3000* / CopperPro 990** Cord Kit

KITCP990BST

**Kit Designed for
HST-3000 /
CopperPro Test Set &
Far End Device**

(1) PN # **FLFED463G**
RJ45 to
Blue 463A / Red 463A / Gnd, (6')
(call for individual pricing)

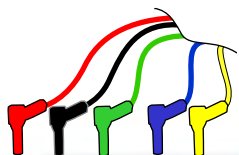

*Fluke TN2100
& CopperPro
not included*



(1) PN # **TCC001**
8 Pouch Carrying Case
(call for individual pricing)

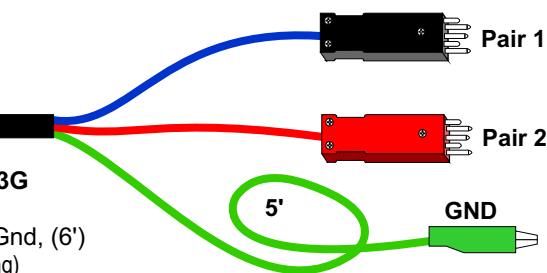

- (1) WINBUY # **FL400100SBY**
HST / Fluke to 463A Protector (Blue), (6')
- (1) WINBUY # **FL400100SRD**
HST / Fluke to 463A Protector (Red), (6')
- (1) WINBUY # **FL400100WPBY**
HST / Fluke to Wire Wraps (Blue), (6')
- (1) WINBUY # **FL400100WPRD**
HST / Fluke to Wire Wraps (Red), (6')
- (1) WINBUY # **FL400100BY**
HST / Fluke to Bantam (Blue), (6')
- (1) WINBUY # **FL400100BR**
HST / Fluke to Bantam (Red), (6')
- (1) WINBUY # **FL400409**
Ground Cord, (8')

Ordering Information:

HST-3000 / CopperPro 990 Cord Kit

includes: (1) FLFED463G, (1) FL400100SBY, (1) FL400100SRD, (1) FL400100WPBY,
(1) FL400100WPRD, (1) FL400100BBY, (1) FL400100BRD, (1) FL400409 & (1) TCC001

**WINBUY # (KIT)
KITCP990BST**

150 Cooper Rd. (F-15)
W. Berlin, NJ 08091

www.tagcords.com

Telephone: (856) 753-8585
Fax : (856) 768-7645

Telecom Assistance Group

JDSU HST-3000* Test Cords

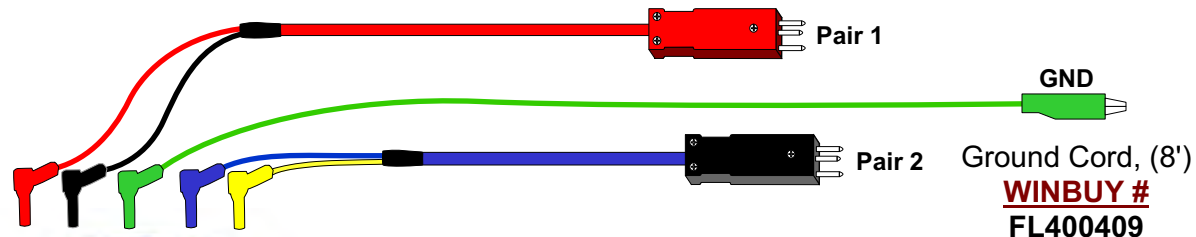

**** Kits are Available -
Please Call
for more Information ****



8 Pouch Carrying Case
PN # TCC01
(call for pricing)

HST to 463A Protector (Red), (6')
WINBUY # FL400100SRD



HST to 463A Protector (Blue), (6')
WINBUY # FL400100SBY



HST to Wire Wraps (Red), (6')
WINBUY # FL400100WPRD



HST to Wire Wraps (Blue), (6')
WINBUY # FL400100WPBY



HST to Bantam (Red), (6')
WINBUY # FL400100BR



HST to Bantam (Blue), (6')
WINBUY # FL400100BY



150 Cooper Rd. (F-15)
W. Berlin, NJ 08091

www.tagcords.com

Telephone: (856) 753-8585
Fax : (856) 768-7645

Telecom Assistance Group

BST - DLC Cord Kit

DLCKITBST



(1) # **TCC001** - 8 Pouch Carrying Case

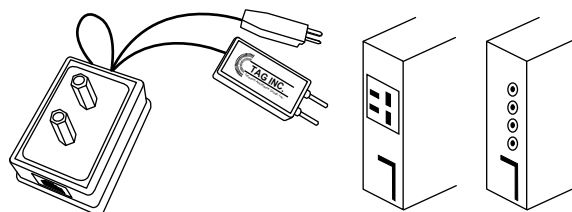

(1) # **4003956** - "The Slick Cord" - Series 5 & SLC 96



(2) # **400210A** - Bantam to (2) Alligator Clips, (6')



(1) # **40070325** - DB9 Pin (f) to DB25 Pin (m), (25')



(2) # **408210** - Bantam to 800 DSX, (6')



(1) # **400722ADSL** - Catena DB9 Pin (f) to RJ45, (6')



(2) # **400210WP** - Bantam to Wire Wraps, (6')



(1) # **400720** - DB9 Pin (m) to DB9 Pin (f), (6')

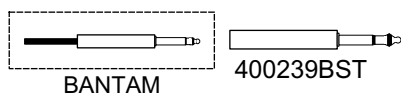

(2) # **400239BST** - Bantam to 310 Conversion Plug



(1) # **400703H25** - DB9 Pin (m) to DB25 Pin (m), (25')



(1) # **400440BLP** - BNC Loopback Cord, (9')

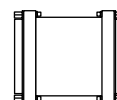

(1) # **400725N** - 25 Pin (m) to 25 Pin (f) "NULL" Adapter



(1) # **400210BK** - Bantam to Bantam, RX - Black, (6')



(1) # **400448XP10** - DMX Provisioning (CAT5E) Cable, (10')



(1) # **400210RD** - Bantam to Bantam, TX - Red, (6')



(1) # **40044806** - RJ48 to RJ48, (6')

Ordering Information:

BST - DLC Cord Kit

includes: (2) 400210A, (1) 400210BK, (1) 400210RD, (2) 408210, (1) 400720, (2) 400210WP, (2) 400239BST, (1) 4003956, (1) 400725N, (1) 40070325, (1) 400448XP10, (1) 400440BLP, (1) 400703H25, (1) 400722ADSL, (1) 40044806 & (1) TCC001

WINBUY # (KIT)
DLCKITBST

150 Cooper Rd. (F-15)
W. Berlin, NJ 08091

www.tagcords.com

Telecom Assistance Group

Telephone: (856) 753-8585
Fax : (856) 768-7645

"Green Coil Cord"**400300FP****"Frogger" Protector Test Cord, (20')**

1. Insert "Good" (green) plug into known good line.
2. Insert "Bad" (red) plug into bad line for temporary restoration.

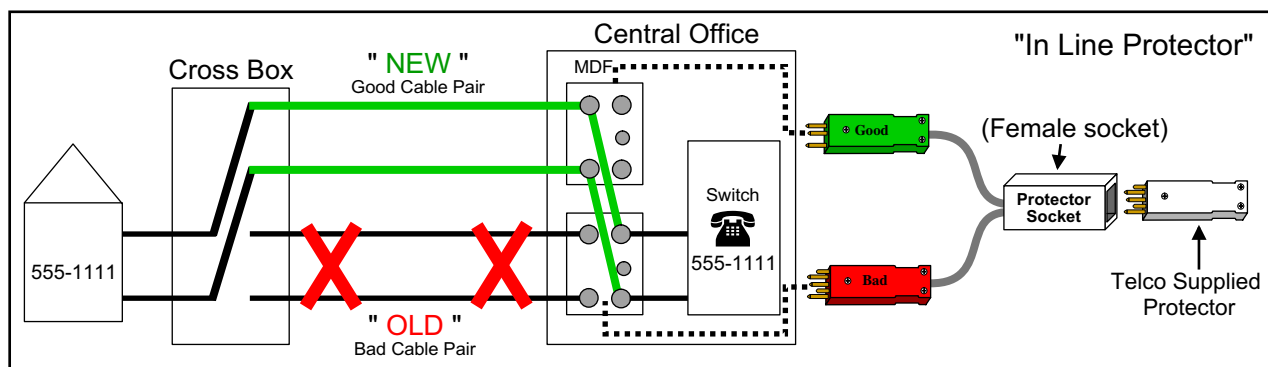
**Application:**

TAG's Temporary Restoral Cord (400300FP) allows you to add protection back to the telephone line when testing. TAG's test cord features a built-in protector socket that accepts any 5-pin protector module. A 5-pin module with the same specifications as the line you are testing on must be inserted before the test cord can function. Once inserted, the cord will now function and protection has been restored to the line.

In the event of a power or lightning strike, TAG's 400300FP can save thousands of dollars by eliminating dangers that can destroy expensive equipment or possibly harm a technician. One plug is Green "GOOD" & the other plug is Red "BAD". When the repair is made, the circuit can be identified as to which pair is good or bad.

Ordering Information:**"Frogger" Protector Test Cord - (20')*****WINBUY #****400300FP****Available in various lengths. Call for Pricing.*

150 Cooper Rd. (F-15)
W. Berlin, NJ 08091

www.tagcords.com

Telephone: (856) 753-8585
Fax : (856) 768-7645

Telecom Assistance Group

Colt 250* / Exfo 635* Test Cords

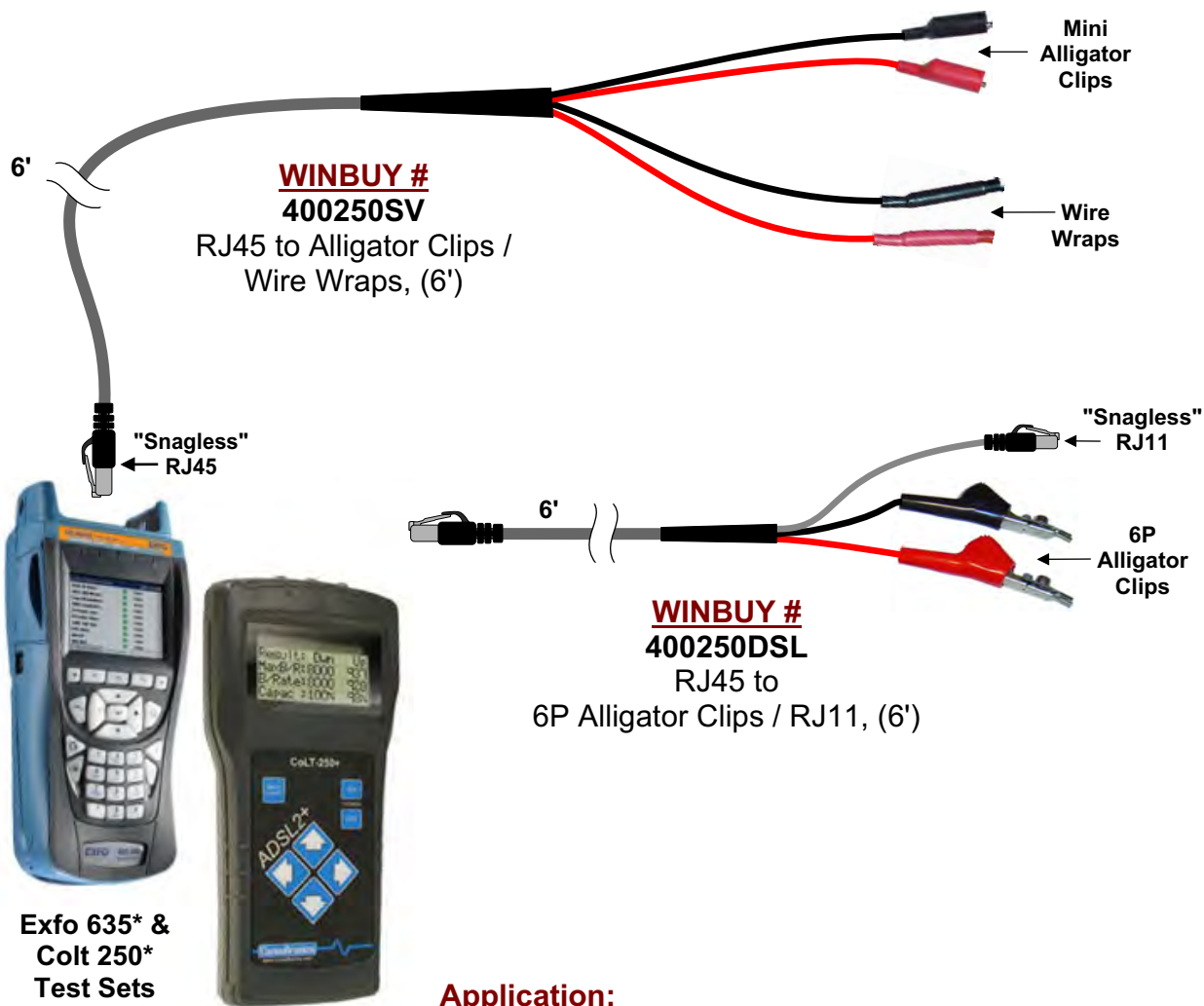

Exfo 635* & Colt 250* Test Sets
(not included)

Application:

The cords shown above are used with the Colt 250* and/or Exfo 635* test set to perform DSL testing.

Ordering Information:

- RJ45 to Mini Alligator Clips / Wire Wraps, (6')
- RJ45 to 6P Alligator Clips / RJ11, (6')

- WINBUY #**
400250SV
400250DSL

150 Cooper Rd. (F-15)
W. Berlin, NJ 08091

www.tagcords.com

Telephone: (856) 753-8585
Fax : (856) 768-7645

Telecom Assistance Group

Calix C7 Streaker Kit

C7KIT01

"Calix C7"



The (# C7KIT01) Kit Includes:

(1) STCALIXC7
Calix C7 Streaker Card w/ LEDs

Application:

The STCALIXC7 provides a quick method to "streak", verify wiring via LEDs, from the backplane of the Calix C7 to the Frame. At the Frame simply ground the corresponding pins and the STCALIXC7 will light the LED associated with that connection.



Approx. Dimensions:
13" (H) x 20" (L)



(1) P2000
Protected (-48V) Test Probe w/ LED, (6')



(1) 400409
Pin Plug to Alligator, (6')



(1) 600209F
Carrying Case

Ordering Information:

Calix C7 Streaker Kit
includes: (1) STCALIXC7, (1) 400409, (1) P2000 & (1) 600209F

WINBUY # (KIT)
C7KIT01

150 Cooper Rd. (F-15)
W. Berlin, NJ 08091

www.tagcords.com

Telephone: (856) 753-8585
Fax : (856) 768-7645

Telecom Assistance Group

Apparatus Cases (T1, HDSL, DDS)

WINBUY # EXT209B (w/ Bantam Jacks) T1 Loopback Extender

Application:

- Universal interface to all test sets
- Loops signal and simplex current
- Isolates trouble to repeater or cable
- Bantam Jack access eliminates special probes and cables
- Direct metallic bridging allows current, voltage and loop resistance measurements



WINBUY # EXT209TB (w/ Bantam Jacks) T1 Repeater Extender

Application:

- Span current test points
- Loops signal and simplex current
- Test repeaters in the field
- Bantam Jack access to monitor/transmit QRSS, 3 in 24 from test sets
- Direct metallic bridging allows current, voltage and loop resistance measurements



WINBUY # CT239239 T1 Line Repeater Cut Thru Card

Application:

The CT239239 plugs into T1, 56KB, HDSL, and ISDN apparatus cases. Plug the CT239239 into non-powered mini T1 line repeater slots to bypass unused pairs for line testing.

150 Cooper Rd. (F-15)
W. Berlin, NJ 08091

www.tagcords.com
Telecom Assistance Group

Telephone: (856) 753-8585
Fax: (856) 768-7645

T1 Repeater Test Kit

EXT238K3

The EXT238K3 Kit is designed for technicians who test at T1 Line Repeater Housings, such as 818 apparatus cases. (see Fig. 1) The Kit Includes:



Fig. 1



(1) EXT238
T1 Line Repeater Access Board



(1) 600209
Carrying Case



(1) 400210RD03
Bantam to Bantam - Red, (3')



(1) 400210ARD03
Bantam to Alligator Clips - Red, (3')



(1) 400210BK03
Bantam to Bantam - Black, (3')



(1) 400210ABK03
Bantam to Alligator Clips - Black, (3')

Ordering Information:

T1 Repeater Access Kit

includes: (1) EXT238, (1) 400210RD03, (1) 400210BK03,
(1) 400210ARD03, (1) 400210ABK03 & (1) 600209

WINBUY # (KIT)

EXT238K3

T1 Line Repeater Wiring Access Board (w/ Bantam Jacks)

EXT238

150 Cooper Rd. (F-15)
W. Berlin, NJ 08091

www.tagcords.com

Telephone: (856) 753-8585
Fax : (856) 768-7645

Telecom Assistance Group

Apparatus Cases (T1, HDSL, DDS)

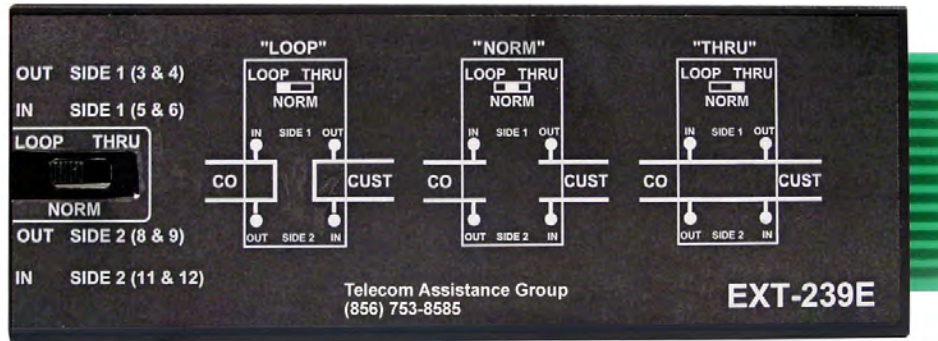

WINBUY # EXT239E

Plugs into T1, 56KB, HDSL, ISDN Apparatus Cases

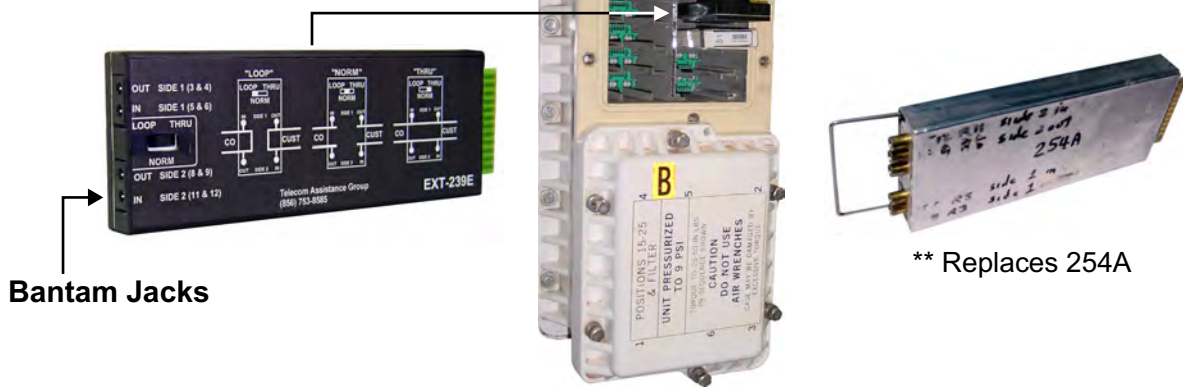

Features:

- Enhanced switch settings for Thru, Norm, and Loop testing at T1 line repeater apparatus cases
- Metallic access at T1 line repeater slots
- Use with test sets to perform Cable Loss, Resistance, or TDR test set to locate load coils

Ordering Information:

T1 Wiring Access Board
Bantam to Alligator Clips, (6')

WINBUY

EXT239E
400210A

Carrying Case is available (PN # 600209) - Call for Pricing

150 Cooper Rd. (F-15)
W. Berlin, NJ 08091

www.tagcords.com

Telephone: (856) 753-8585
Fax : (856) 768-7645

Telecom Assistance Group

ORB Test Kit

KITTB0RB



WINBUY # TB86B
 "DDM Plus" Office Repeater
 Test Board w/ Bantam Jacks



WINBUY # TB3192B
 3190/3192 Office Repeater
 Test Board w/ Bantam Jacks



TB231B
 220 (Kentrox size) Office Repeater
 Test Board w/ Bantam Jacks



TB400B
 HDSL Remote HRU-200/400
 Mechanics w/ Bantam Jacks



WINBUY # EXT239E
 T1 Line Repeater Access Board
 w/ Bantam Jacks

WINBUY # 400210A
 (1) Bantam to Alligator Clips-Red, (6')



WINBUY # 400210A
 (1) Bantam to Alligator Clips-Black, (6')



600209N
 Carrying Case

Ordering Information:

ORB Test Kit

includes: (1) TB86B, (1) TB231B, (1) TB3192B, (1) TB400B,
 (1) EXT239E, (2) 400210A & (1) 600209N - carrying case

WINBUY # (KIT)
KITTB0RB

150 Cooper Rd. (F-15)
 W. Berlin, NJ 08091

www.tagcords.com

Telecom Assistance Group

Telephone: (856) 753-8585
 Fax : (856) 768-7645

ORB Test Kit

KITTB0RBB02



WINBUY # TB86B
 "DDM Plus" Office Repeater
 Test Board w/ Bantam Jacks



WINBUY # TB3192B
 3190/3192 Office Repeater
 Test Board w/ Bantam Jacks



TB231B
 220 (Kentrox size) Office Repeater
 Test Board w/ Bantam Jacks



WINBUY # TBTA3000RB
 Adtran Total Access 3000 Test Board
 w/ Bantam Jacks



TB400B
 HDSL Remote HRU-200/400
 Mechanics w/ Bantam Jacks



WINBUY # EXT239E
 T1 Line Repeater Access Board
 w/ Bantam Jacks

WINBUY # 400210A
 (1) Bantam to Alligator Clips-Red, (6')



WINBUY # 400210A
 (1) Bantam to Alligator Clips-Black, (6')



600209N
 Carrying Case

Ordering Information:

ORB Test Kit

includes: (1) TB86B, (1) TB231B, (1) TB3192B, (1) TB400B,
 (1) TBTA3000ORB, (1) EXT239E, (2) 400210A & (1) 600209N - carrying case

WINBUY # (KIT)
KITTB0RBB02

150 Cooper Rd. (F-15)
 W. Berlin, NJ 08091

www.tagcords.com

Telecom Assistance Group

Telephone: (856) 753-8585
 Fax : (856) 768-7645

Portable "R" - HDSL Test Kit

RHDSLBST01

RHDSLBST01
Portable "R" - HDSL Test Kit

KIT INCLUDES CARRYING CASE



(1) 600509
Carrying Case
Approx. Dimensions:
8" (H) x 9" (L)

(1) TRHDSL
Portable "R" HDSL Test Unit



(cards not included)

4W6P08 →

- ▶ **4 Slots for 200/400 Mech. HDSL "R" Cards**
- ▶ **Rugged Connectors**
- ▶ **Various Test Cords**

(1) 4W6P08
Female Lock Plug to
(4) 6P Alligator Clips, (8')

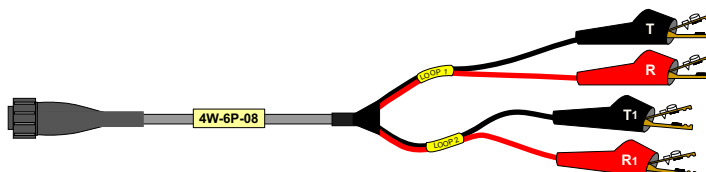

(1) 4W463Y08
Female Lock Plug to
5 Pin "Y" Protector, (8')

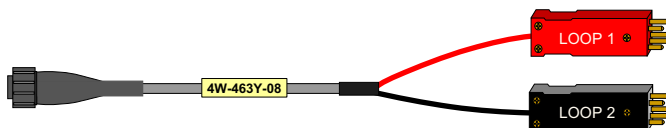

Ordering Information:

Portable "R" - HDSL Test Kit
includes: (1) T-RHDSL, (1) 4W-6P-08, (1) 4W-463Y-08 &
(1) 600509 - carrying case

Female Lock Plug to (4) 6P Alligator Clips, (8')

Female Lock Plug to 5 Pin "Y" Protector, (8')

WINBUY # (KIT)
RHDSLBST01

4W6P08

4W463Y08

150 Cooper Rd. (F-15)
W. Berlin, NJ 08091

www.tagcords.com
Telecom Assistance Group

Telephone: (856) 753-8585
Fax: (856) 768-7645

Portable HDSL "C" Test Unit - 3192 & 220 Kit

PHTUC02KIT01

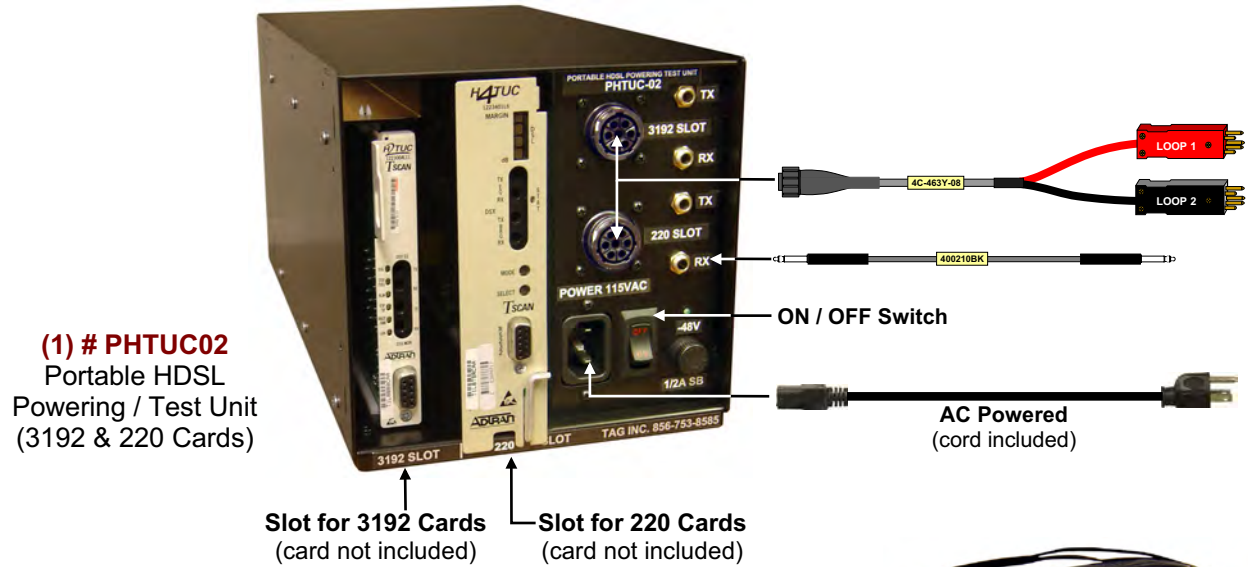

- ▶ 2 Slots (3192 & 220)
- ▶ Bantam Jacks for T1 Test Sets
- ▶ Isolates Troubles
- ▶ New Installs

KIT INCLUDES CARRYING CASE

(1) # 600510
Carrying Case
Approx. Dimensions:
14" (H) x 9" (L) x 7" (D)

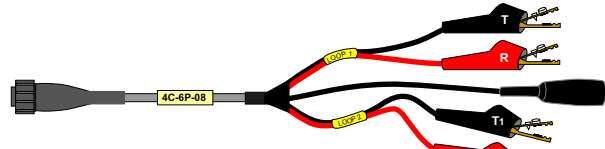

(1) # 4C6P08
Male Lock Plug to (4) 6P Alligator Clips w/ GND, (8')

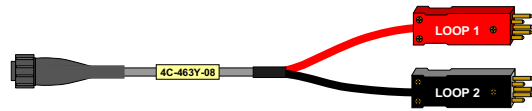

(1) # 4C463Y08
Male Lock Plug to 5 Pin "Y" Protector, (8')

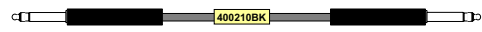

(1) # 400210BK
Bantam to Bantam Test Set Cord - Black, (6')

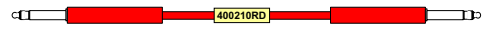

(1) # 400210RD
Bantam to Bantam Test Set Cord - Red, (6')

Ordering Information:

Portable HDSL "C" Test Unit - 3192 & 220 Kit
includes: (1) PHTUC02, (1) 4C463Y08, (1) 4C6P08, (1) 400210RD,
(1) 400210BK & (1) 600510 - carrying case

WINBUY # (KIT)
PHTUC02KIT01

150 Cooper Rd. (F-15)
W. Berlin, NJ 08091

www.tagcords.com

Telephone: (856) 753-8585
Fax : (856) 768-7645

Telecom Assistance Group

New Replacement Dumb Terminals - Transport / DACS Equipment

**NEW TERMINAL WORKS ON
Titan 5500, CS1, CS1L, DACS II, III, IV, Alcatel 1631 & HDSL**
(Titan 5500 shown below)

REMOVE & REPLACE OLD / BROKEN CRTs

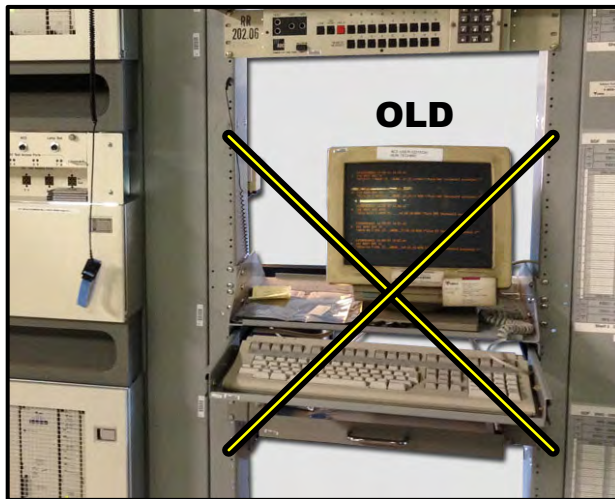

SPECIFICATIONS

- VT-100 COMPATIBLE
- PRINTER OUTPUT
- RS-232 INPUT(S)
- LOW POWER

Ordering Information:

Single Session Dumb Terminal - Transport

includes: (1) 17" Flat Screen Monitor, (1) Keyboard,
(1) Single Session Terminal Controller,
(1) DB25M Gender Changer & (1) Quick Guide

WINBUY

TTVT100S

Single Session Dumb Terminal - 1631 DACS

includes: (1) 17" Flat Screen Monitor, (1) Keyboard w/ 1631 labels,
(1) Pre-configured 1631 Single Session Terminal Controller,
(1) DB25M Gender Changer & (1) 1631 Quick Guide

TTSCA1631

Dual Session Dumb Terminal - Titan 5500

includes: (1) 17" Flat Screen Monitor, (1) Keyboard,
(1) Pre-configured Titan 5500 Dual Session Terminal Controller,
(2) DB25F Gender Changers & (1) Titan 5500 Quick Guide

TTDCT55

150 Cooper Rd. (F-15)
W. Berlin, NJ 08091

www.tagcords.com

Telephone: (856) 753-8585

Fax : (856) 768-7645

Telecom Assistance Group

DMS Terminal Replacements - Dual Session

Model:

TTDCAPDMSKIT2

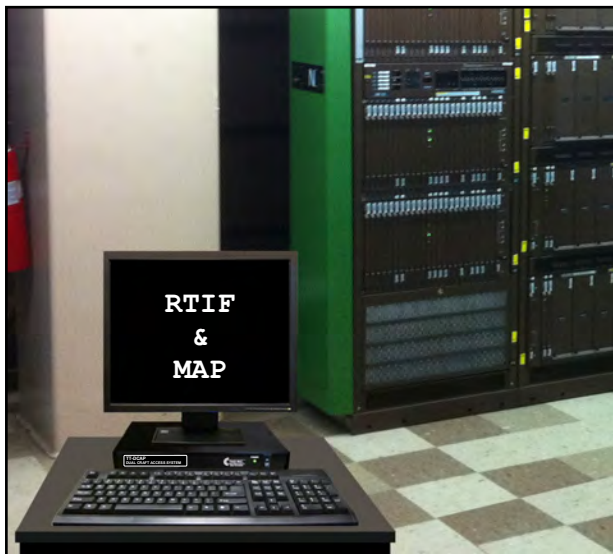

Kit Includes (TTDCAPDMSKIT2):

- (1) 17" Flat Screen Monitor
- (1) Dumb Terminal Controller
- (1) Keyboard
- (1) Quick Guide
- (2) 400725SBW,
(Hardwire Adapter for 400725SB2)
- (2) 400700,
(DB25F Gender Changer) 
- (2) 400725SB2,
(DMS Quick Connect Current Loop Adapter Cable w/ DEC Connector)



SPECIFICATIONS

- VT-100 COMPATIBLE
- DUAL RS-232 INPUTS
- PRINTER OUTPUT
- LOW POWER

Printer Port Type:



Parallel * * If a Serial Port is needed, please order a Parallel to Serial Adapter # TTPSA, call for pricing.

Ordering Information:

Dual Craft Access System - DMS (Kit 2)

includes: (1) 17" Flat Screen Monitor, (1) Keyboard,
 (1) Dual Session Dumb Terminal Controller, (1) Quick Guide,
 (2) # 400700 (DB25F Gender Changer),
 (2) # 400725SB2 (DMS Quick Connect Current Loop Adapter Cable w/ DEC Connector) &
 (2) # 400725SBW (Hardwire Adapter for 400725SB2)

WINBUY #
TTDCAPDMSKIT2

Dual Craft Access System - DMS

includes: (1) 17" Flat Screen Monitor, (1) Keyboard,
 (1) Dual Session Dumb Terminal Controller, (1) Quick Guide &
 (2) # 400700 (DB25F Gender Changer)

TTDCAP

Replacement Power Pack for DMS Terminal, 5VDC (not shown)

TTDCA5PP
 (call for pricing)

150 Cooper Rd. (F-15)
 W. Berlin, NJ 08091

www.tagcords.com

Telephone: (856) 753-8585
 Fax : (856) 768-7645

Telecom Assistance Group

DMS Replacement Terminals - Single Session

Model:

TTSCAPDMSKIT



Kit Includes:

- (1) 17" Flat Screen Monitor
- (1) Dumb Terminal Controller
- (1) Keyboard
- (1) Quick Guide
- (1) 400700, (DB25F Gender Changer) 
- (1) 400725SB2, (DMS Quick Connect Current Loop Adapter Cable w/ DEC Connector)



SPECIFICATIONS

- VT-100 COMPATIBLE
- SINGLE RS-232 INPUT
- PRINTER OUTPUT
- LOW POWER

Printer Port Type:



Parallel *

* If a Serial Port is needed, please order a Parallel to Serial Adapter (# TTPSA). Please call 856-753-8585 for more information.

Ordering Information:

DMS Single Session Replacement Terminal Kit

- includes: (1) 17" Flat Screen Monitor, (1) Keyboard,
 (1) Single Session Dumb Terminal Controller, (1) Quick Guide,
 (1) # 400700 (DB25F Gender Changer) &
 (1) # 400725SB2 (DMS Quick Connect Current Loop Adapter Cable w/ DEC Connector)

WINBUY #
TTSCAPDMSKIT

DMS Single Session Replacement Terminal Kit 2

- includes: (1) 17" Flat Screen Monitor, (1) Keyboard,
 (1) Single Session Dumb Terminal Controller, (1) Quick Guide,
 (1) # 400700 (DB25F Gender Changer) &
 (1) # 400725SB2 (DMS Quick Connect Current Loop Adapter Cable w/ DEC Connector)
 (1) # 400725SBW** (Hardwire Adapter for 400725SB2) **not shown

TTSCAPDMSKIT2

Replacement Power Pack for DMS Terminal, 5VDC (not shown)

TTDCA5PP
 (call for pricing)

150 Cooper Rd. (F-15)
 W. Berlin, NJ 08091

www.tagcords.com

Telephone: (856) 753-8585
 Fax : (856) 768-7645

Telecom Assistance Group

Siemens EWSD OMT* Terminal Replacements



Model:

TTDCAM0T

(1) 17" Flat Screen Monitor

(1) EWSD® OMT® Controller

(1) Keyboard

(1) TTMOUSEPS
(Optical Mouse)

(1) 400700
(DB25F Gender Changer)

Back of Terminal Controller:



Ordering Information:

Siemens EWSD OMT Craft Access System
includes: (1) 17" Flat Screen Monitor,
(1) Keyboard, (1) EWSD OMT Controller,
(1) # TTMOUSEPS & (1) # 400700

WINBUY #
TTDCAM0T

Replacement Power Pack for EWSD Terminal, 5VDC

TTDCA5PP
(call for pricing)

150 Cooper Rd. (F-15)
W. Berlin, NJ 08091

www.tagcords.com

Telephone: (856) 753-8585
Fax : (856) 768-7645

Telecom Assistance Group

GTD5 Terminal Replacements - Dual Session

Model:

TTDCAG5



Includes:

- (1) 17" Flat Screen Monitor
- (1) Dumb Terminal Controller
- (1) TTMTG5
(Vertical Mounting Kit)
- (1) Keyboard
- (1) Quick Guide
- (2) 400701,
(DB25M Gender Changer)



SPECIFICATIONS

- VT-100 COMPATIBLE
- DUAL RS-232 INPUTS
- PRINTER OUTPUT
- LOW POWER

Printer Port Type:



Parallel *

* If a Serial Port is needed, use the Parallel to Serial Adapter (PN # TTPSA) that is included in the kit.

Ordering Information:

Dual Craft Access System - GTD5 Kit

includes: (1) 17" Flat Screen Monitor, (1) Keyboard,
(1) Dual Session Dumb Terminal Controller, (1) Quick Guide,
(1) # TTMTG5 (Vertical Mounting Kit),
(2) # 400701 (DB25M Gender Changer) &
(1) # TTPSA** (Parallel to Serial Printer Adapter w/ AC Power Pack) **not shown

WINBUY #
TTDCAG5KIT1

Replacement Power Pack for GTD5 Terminal, 5VDC (not shown)

TTDCA5PP
(call for pricing)

150 Cooper Rd. (F-15)
W. Berlin, NJ 08091

www.tagcords.com

Telephone: (856) 753-8585
Fax : (856) 768-7645

Telecom Assistance Group

5ESS Terminal Replacements - Dual Session

Model:

TTDCAPCE



Includes:

- (1) 17" Flat Screen Monitor
- (1) Dumb Terminal Controller
- (1) Keyboard
- (1) Quick Guide
- (2) 400701,
(DB25M Gender Changer)



SPECIFICATIONS

- VT-100 COMPATIBLE
- DUAL RS-232 INPUTS
- PRINTER OUTPUT
- LOW POWER

Printer Port Type:



Parallel * * If a Serial Port is needed, please order a Parallel to Serial Adapter (PN # TTPSA). Call 856-753-8585 for more information.

Ordering Information:

Dual Craft Access System - 5ESS

includes: (1) 17" Flat Screen Monitor, (1) Keyboard,
(1) Dual Session Dumb Terminal Controller, (1) Quick Guide &
(2) # 400701 (DB25M Gender Changer)

WINBUY #
TTDCAPCE

Replacement Power Pack for 5ESS Terminal, 5VDC (not shown)

TTDCA5PP
(call for pricing)

150 Cooper Rd. (F-15)
W. Berlin, NJ 08091

www.tagcords.com

Telephone: (856) 753-8585
Fax : (856) 768-7645

Telecom Assistance Group

5ESS Terminal Replacements - Single Session

Model:

TTSCAPCE



Includes:

- (1) 17" Flat Screen Monitor
- (1) Dumb Terminal Controller
- (1) Keyboard
- (1) Quick Guide
- (1) 400701,
(DB25M Gender Changer)



SPECIFICATIONS

- VT-100 COMPATIBLE
- SINGLE RS-232 INPUT
- PRINTER OUTPUT
- LOW POWER

Printer Port Type:



Parallel * * If a Serial Port is needed, please order a Parallel to Serial Adapter (PN # TTPSA). Call 856-753-8585 for more information.

Ordering Information:

Single Craft Access System - 5ESS

includes: (1) 17" Flat Screen Monitor, (1) Keyboard,
(1) Single Session Dumb Terminal Controller, (1) Quick Guide &
(1) # 400701 (DB25M Gender Changer)

WINBUY #

TTSCAPCE

Replacement Power Pack for 5ESS Terminal, 5VDC (not shown)

TTDCA5PP
(call for pricing)

150 Cooper Rd. (F-15)
W. Berlin, NJ 08091

www.tagcords.com

Telephone: (856) 753-8585
Fax : (856) 768-7645

Telecom Assistance Group

DMS-100 Replacement Fans

"DMS-100"

WINBUY # TFDMS01
 48 Volt Replacement Fan for
DMS-100 NT3X90AC / NTB63AA
Fan Trays

w/ Power Prongs &
 (4) Threaded* Mounting Holes
 (screws included)



** also available unthreaded - see ordering information below*

DO YOU HAVE BROKEN DMS SENSOR PADDLES THAT NEED TO BE REPLACED?
TAG HAS NEW OPTIONS (where you won't need paddles anymore)
 call 856-753-8585 or email www.custsvcs@tagcords.com



EXISTING NT3X90AC FAN TRAY w/ NEW FANS



Ordering Information:

48V Fan for DMS-100 NT3X90AC / NTB63AA
Fan Trays w/ Power Prongs &
(4) Threaded Mounting Holes (*screws included*)

48V Fan for DMS-1U NT3X90AC / NTB63AA
Fan Trays w/ Power Prongs &
(4) Clear, Unthreaded Mounting Holes (*not shown*)

WINBUY #

TFDMS01

TFDMS02
 (call for pricing)

150 Cooper Rd. (F-15)
 W. Berlin, NJ 08091

www.tagcords.com

Telephone: (856) 753-8585
 Fax : (856) 768-7645

Telecom Assistance Group

DMS-100 Replacement Fans



WINBUY # TFDMS03
DMS-100, 48 Volt Replacement Fan
w/ TTL Tach & 3 Wire Plug

(use in Nortel NT3X90AF fan trays)

NEW Alarm Control Boards are also available,
order # TFC-3X90AF-01 (call for pricing)

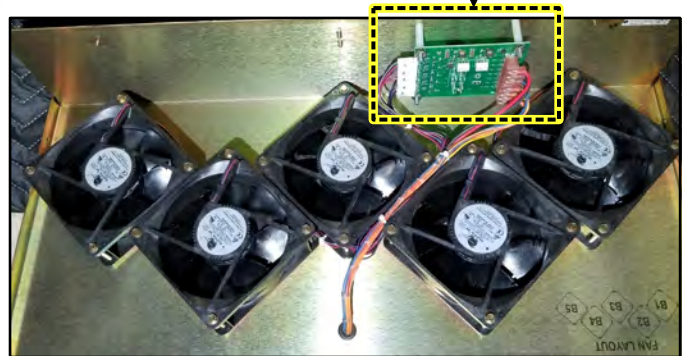

NORTEL NT3X90AF →
DMS-100 SWITCH BAY (DC POWERED)
w/ EXISTING FANS (5 FANS PER TRAY)



NORTEL NT3X90AA / NT3X90AB
DMS-100 SWITCH BAY (AC POWERED)
w/ EXISTING FANS (5 FANS PER TRAY)

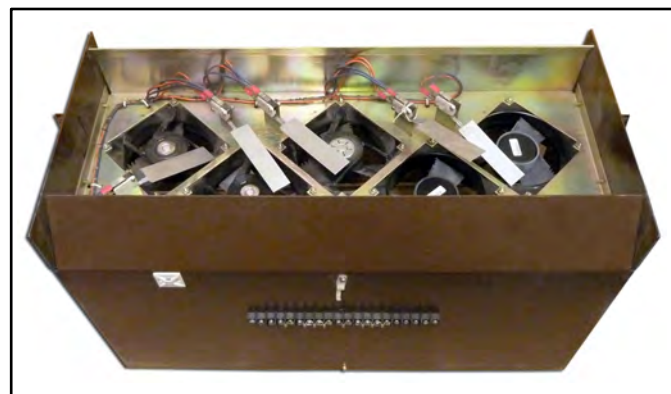

WINBUY # TFDMS04AC
DMS-100, 24 VAC Replacement Fan
w/ Power Prongs

*(use in Nortel NT3X90AA &
NT3X90AB fan trays)*

*Direct replacement for
Nortel 24 VAC fan units.*

150 Cooper Rd. (F-15)
W. Berlin, NJ 08091

www.tagcords.com

Telephone: (856) 753-8585
Fax : (856) 768-7645

Telecom Assistance Group

Replacement Fans & Blowers (DMS-10 / DMS-100)

"DMS-10"

Power Prongs



WINBUY # TFDMS1001
DMS-10, 48 Volt Replacement Fan
w/ Power Prongs
(fan only, use with existing mounting)



FAN SHOWN w/ EXISTING DMS-10 MOUNTING BRACKET *
**(mounting bracket is not included)*

WINBUY # TFDMSLGN5

DMS-100 DPCC
SuperNode Blower "Squirrel Cage"
Replacement w/ Internal Sensor

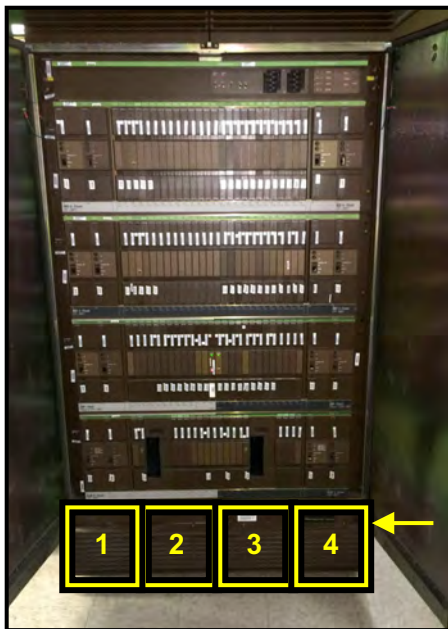

"DMS-100"



(use in NT9X01XX DPCC, replaces A0345301)

NT9X01XX DPCC HAS (4) BLOWER UNITS PER BAY

150 Cooper Rd. (F-15)
W. Berlin, NJ 08091

www.tagcords.com

Telephone: (856) 753-8585
Fax : (856) 768-7645

Telecom Assistance Group

Replacement Fans (Edgelink 100 / Cisco ONS 15454)

"ADTRAN TA5000"

WINBUY # TFTA5K01
 48 Volt Replacement Fan for
Adtran TA5000
 w/ 4 Wire Plug



40mm



"EDGELINK 100"

WINBUY # TFEL100KIT2
Edgelink 100,
 Replacement Fan Kit (40mm)

Kit includes:

- (1) TF-EL100, Edgelink 100 Replacement Fan (40mm) &
- (1) TF-EL100DET, Edgelink 100 Replacement Detector PC Board

- 35mm Edgelink 100 fans are also available, order WINBUY # TFEL10002



"ONS 15454"

WINBUY # TFC1545401
Cisco ONS 15454,
 48 Volt Replacement Fan
 w/ 3 Wire Right Angle Connector



CISCO ONS 15454 FAN UNIT (6 FANS)
(fan tray unit is not included)



*(use in Fan Tray # 800-21448-02,
 HECI: WMMYAFEGAA)*

150 Cooper Rd. (F-15)
 W. Berlin, NJ 08091

www.tagcords.com

Telephone: (856) 753-8585
 Fax : (856) 768-7645

Telecom Assistance Group

5ESS Replacement Fans



- ▶ All TAG Fans are NEW (No Refurbs)
- ▶ Exact Drop-in Replacements
- ▶ 48V DC 0.40A

DON'T SEE THE FAN YOU NEED?

**Send us a Sample
& we will Find a Match!**

KS22501L3 Models:

WINBUY # TF5ESS01F
5ESS Replacement Fan
w/ 3 Leads & Faston Connectors
(fan w/ power prongs)



PN # TF5ESS01P
5ESS Replacement Fan
w/ 3 Leads & AMP Connector
(fan w/ power prongs)



(call for pricing)

DC Fan Power Cords are available for KS22501L3 type fans
(order TAG MODEL # TFDCPWR01)

KS23912L2 Model:

PN # TF5ESS03P
5ESS Replacement Fan
w/ 4 Leads & AMP Connector



(call for pricing)

KS22501L3A Models:

WINBUY # TF5ESS04F
5ESS Replacement Fan
w/ 5 Leads & Faston Connectors



WINBUY # TF5ESS04P
5ESS Replacement Fan
w/ 5 Leads & AMP Connector



KS23912L1A Models:

PN # TF5ESS02F
5ESS Replacement Fan
w/ 5 Leads & Faston Connectors
w/ Internal Thermal Speed Control Sensor



(call for pricing)

PN # TF5ESS02P
5ESS Replacement Fan
w/ 5 Leads & AMP Connector
w/ Internal Thermal Speed Control Sensor



(call for pricing)

KS23398L2 Model:

Square 5ESS Fans
are also available

PN # TF5ESS10P
ISLU (Square Fan)
48V DC 0.13A
w/ 5 Leads &
AMP Connector



(call for pricing)

150 Cooper Rd. (F-15)
W. Berlin, NJ 08091

www.tagcords.com

Telephone: (856) 753-8585

Fax : (856) 768-7645

Telecom Assistance Group

OSP Cabinet Heat Exchanger Fans

"Noren Cooling Unit"



WINBUY # TFNP040201
48 Volt Replacement Heat Exchanger for
Noren Cooling Unit - Internal (6.71K)
w/ 3 Wire Open End & 3 Butt Splices

Internal fan (circulates the air inside the cabinet, located on lower half)

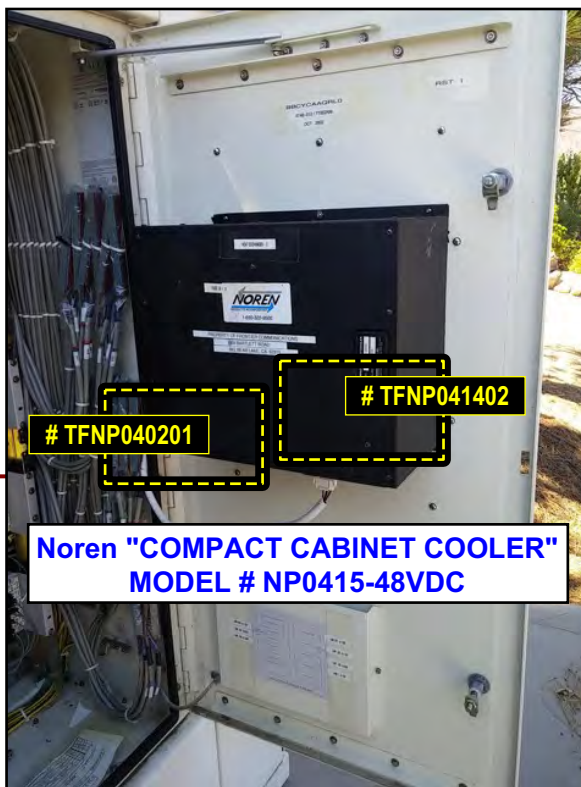

WINBUY # TFNP041402
48 Volt Replacement Heat Exchanger for
Noren Cooling Unit - External (8.45K)
w/ 3 Wire Open End & 3 Butt Splices

External fan (circulates the air outside the cabinet, located on top half)

150 Cooper Rd. (F-15)
W. Berlin, NJ 08091

www.tagcords.com

Telephone: (856) 753-8585
Fax : (856) 768-7645

Telecom Assistance Group

OSP Cabinet Replacement Fans

"SLC96 (36 Type) Cabinet"

WINBUY # TFTSLC96AC01

110VAC Replacement Fan
w/ Bracket Assembly for
SLC96 (36 Type) Cabinet

(Equiv. to Fan Assembly KS22099L5)

(1) 110VAC Replacement Fan *

** fans can also be ordered
separately (without mounting),
see ordering information below*

&

(1) Mounting Bracket



**FAN ASSEMBLY
IS FOUND INSIDE
36 TYPE CABINETS**



Ordering Information:

**110VAC Fan w/ Bracket Assembly for
SLC96 (36 Type) Cabinet** *(Equiv. to Fan Assembly KS22099L5)*

**WINBUY #
TFTSLC96AC01**

Also Available: (call for pricing)

**110VAC (Low Temp) Fan w/ Bracket Assembly for
SLC96 (36 Type) Cabinet** *(Equiv. to Fan Assembly KS22099L5)*

TFTSLC96AC01L

110VAC Fan (fan only) for SLC96 (36 Type) Cabinet
(includes power wire, (3) butt splices & hardware) (use in Fan Assembly KS22099L5)

TFSLC96AC02
(fan only)

150 Cooper Rd. (F-15)
W. Berlin, NJ 08091

www.tagcords.com

Telephone: (856) 753-8585
Fax : (856) 768-7645

Telecom Assistance Group

OSP Cabinet Heat Exchanger Fans

"LS2000 / 2030 - Tarzan"

WINBUY # TFACABT201A
 48V Heat Exchanger (Tarzan) for
 Litespan 2000 (LSC-2030)
 Cabinet Heat Stack



Includes: (1) Adapter Cable (# TFCS-ACABTZX)
 & (3) Butt Splices

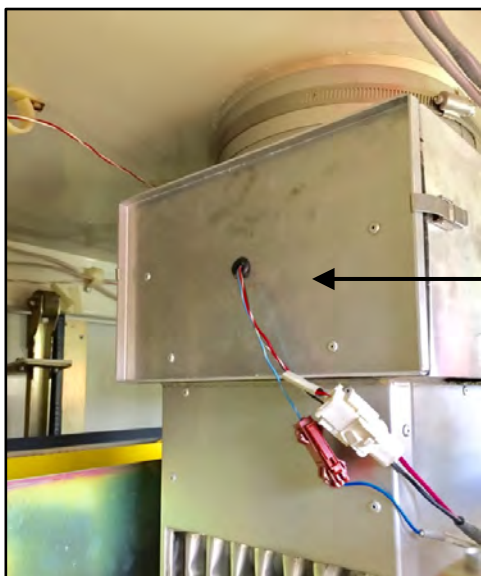

**DSC LITESPAN 2000
 LSC-2030 CABINET
 (INSIDE VIEW OF HEAT STACK)**

w/ (1) - 2 Wire Amp Connector
 (Power, red / black wires)
 &
 (1) - 1 Wire Amp Connector
 (Alarm, blue wire)

"Mesa 768 Cabinet"

(133mm)



*(fan only - use with existing
 mounting bracket)*

WINBUY # TFMC13302
 (133mm) Heat Exchanger for
 Mesa 768 Cabinets
 w/ 3 Pin Plug

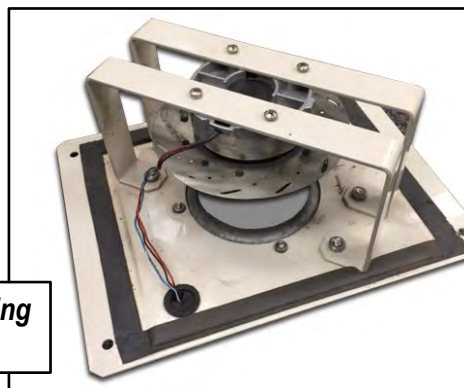

150 Cooper Rd. (F-15)
 W. Berlin, NJ 08091

www.tagcords.com

Telephone: (856) 753-8585
 Fax : (856) 768-7645

Telecom Assistance Group

OSP Cabinet Heat Exchanger Fans

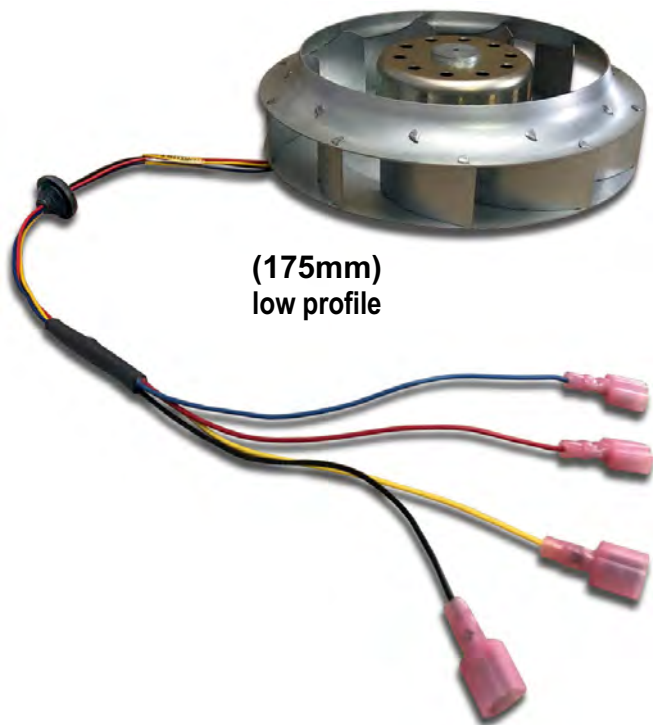

(175mm)
low profile

"ODC Cabinet Door HX"

WINBUY # TFHX175LP01
(175mm) "Low Profile"
Heat Exchanger for
Calix ODC Cabinet Door

*w/ Grommet, 4 Leads
& Faston Connectors*

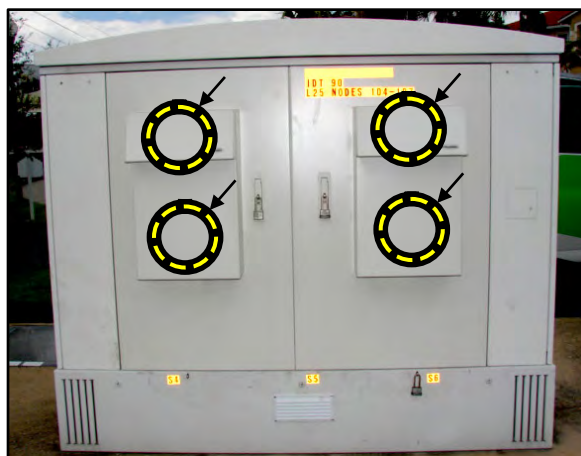

CALIX ODC CABINET (DOOR)

(2) HEAT EXCHANGERS MOUNTED IN EACH DOOR
(4) FANS TOTAL

"ODC 1000 Cabinet HX"

WINBUY # TFHX220LP01
(220mm) "Low Profile"
Heat Exchanger for
Calix ODC 1000 Cabinet

w/ 4 Leads & Faston Connectors

*(fan only,
use with existing mounting bracket)*

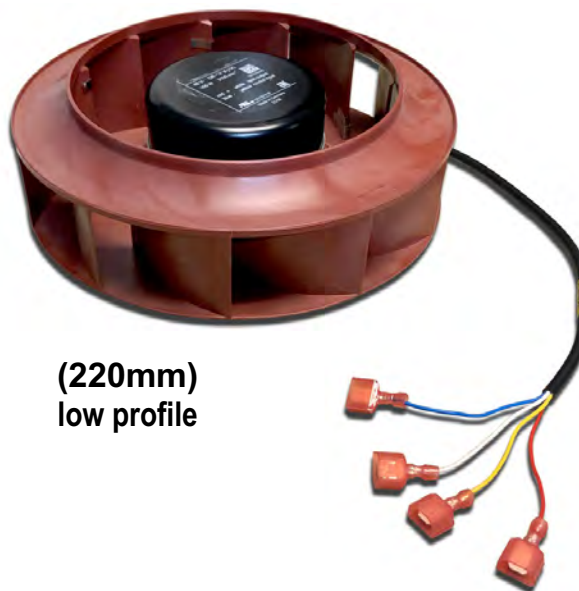

(220mm)
low profile

150 Cooper Rd. (F-15)
W. Berlin, NJ 08091

www.tagcords.com

Telephone: (856) 753-8585
Fax : (856) 768-7645

Telecom Assistance Group

OSP Cabinet Heat Exchanger Fans

- ▶ **Commonly used in Mesa type Cabinets**
- ▶ **Common Replacements for :**
 - EBM R1G225-AC73-XX (where XX=36,38,39,52)
 - EBM R1G225-AF11-XX (where XX=13,14)
 - EBM R1G225-AE07-11 EBM R1G225-AG39-10
 - EBM R1F250-AQ00-XK EBM R1G225-AG15-AA
- ▶ **All TAG Fans are NEW (No Refurbs)**

TOP OF MESA CABINET
w/ EXISTING FAN
(ORDER WINBUY # TFMC22501)



BOTTOM OF MESA CABINET
w/ EXISTING FAN
(ORDER WINBUY # TFMC22502)

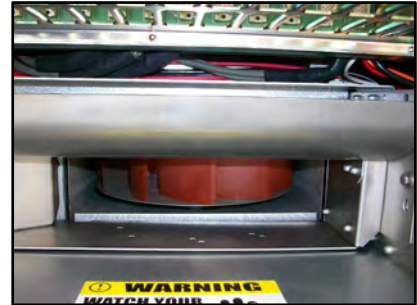

WINBUY # TFMC22501 *
(225mm) Heat Exchanger for
Mesa Cabinet (Top)

w/ Round Weatherproof Connector

** use with existing bracket*

(Fans are accessed through a panel on the solar shield)



WINBUY # TFMC22502 **
(225mm) Heat Exchanger for
Mesa Cabinet (Bottom)

w/ 4 Wire Plug

**** fan only, use with existing bracket -**

(order # TF-MC225-02-KIT for w/ fan & bracket)



150 Cooper Rd. (F-15)
W. Berlin, NJ 08091

www.tagcords.com

Telephone: (856) 753-8585
Fax : (856) 768-7645

Telecom Assistance Group

OSP Cabinet Heat Exchangers & Environmental Control Unit (ECU)

"Mesa DSLAM 384 Cabinet"



WINBUY # TFMESA38401
 48V (External) Heat Exchanger for
 Mesa DSLAM 384 Cabinet
 w/ 4 Wire Round
 Female Weatherproof Plug

*(Internal Fans are also available,
 order WINBUY # TFMESA38402
 (see ordering information below))*



(OUTSIDE - HEAT EXCHANGERS)

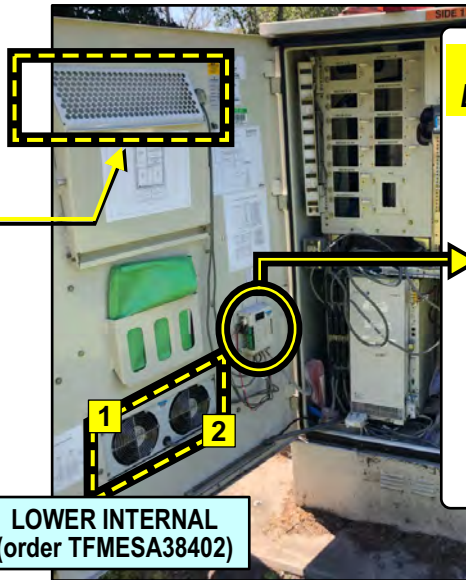
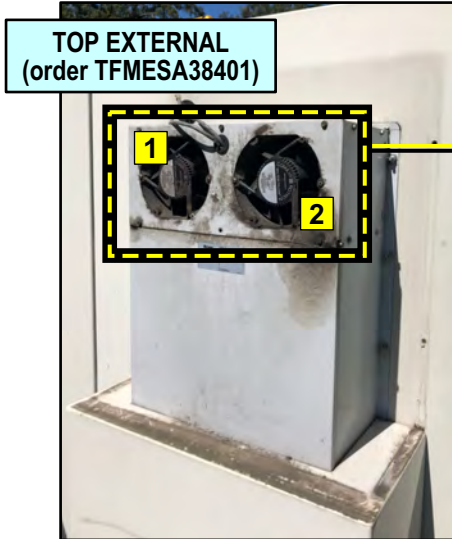

(INSIDE - HEAT EXCHANGERS & ECU)

**Need a Replacement
 ECU for this Cabinet ?**

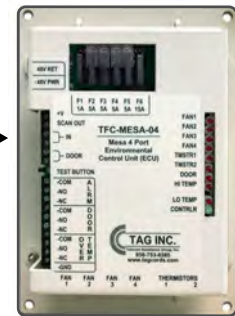

PN # TFCMESA04

Ordering Information:

48V Heat Exchanger for Mesa DSLAM 384 Cabinet w/ 4 Wire (Round)
 Female Weatherproof Plug (*Top External Fans*)

WINBUY #
TFMESA38401

48V Heat Exchanger for Mesa DSLAM 384 Cabinet w/ 4 Wire (Square)
 Female Plug, (8' cable) (*Lower Internal Fans*)

TFMESA38402

4 Port Environmental Control Unit (ECU) Replacement
 (used in Mesa 2 - DSLAM 192 & DSLAM 384 Type Cabinets)

TFCMESA04
 (call for pricing)

150 Cooper Rd. (F-15)
 W. Berlin, NJ 08091

www.tagcords.com

Telephone: (856) 753-8585
 Fax : (856) 768-7645

Telecom Assistance Group

OSP Cabinet Heat Exchanger Fans

"Marconi Mesa (Bottom)"

WINBUY # TFMESA601
48V Replacement Heat Exchanger for
Marconi Mesa "Bottom" HX Cabinet
w/ 3 Wire Plug

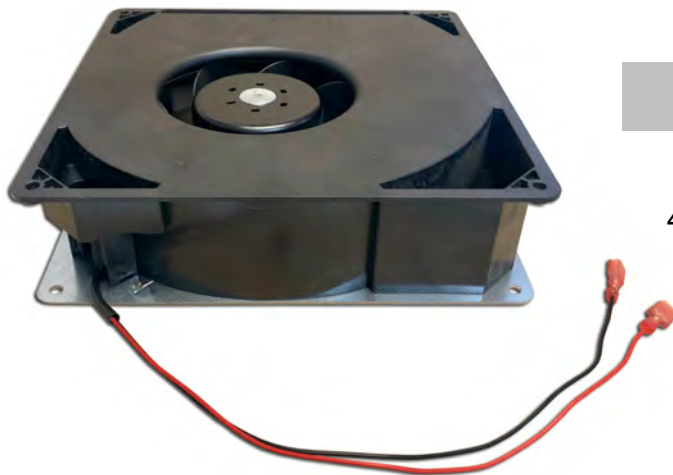
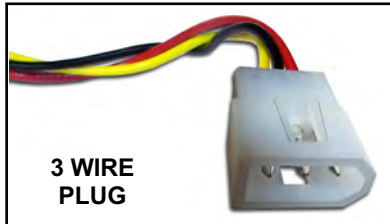

"Calix ODC Stack"

WINBUY # TFCLX0DC01F
48V Replacement Heat Exchanger for
Calix ODC Heat Stack
*w/ 2 Wires &
Faston Connectors*

"AFC Cabinet Stack"

WINBUY # TFAFC67201
48V Replacement Fan for
AFC Cabinet Heat Stack
w/ Power Prongs



150 Cooper Rd. (F-15)
W. Berlin, NJ 08091

www.tagcords.com

Telephone: (856) 753-8585
Fax : (856) 768-7645

Telecom Assistance Group

OSP Cabinet Replacement Fans

"OPAC / OPM"

WINBUY # TFNT0PAC
 48 Volt Replacement Fan for
Nortel Opac / OPM Cabinet
 w/ Round Weatherproof Connector

*(Replaces Nortel # A0381740 / # A33230 (-51)),
 Fits first generation
 Access Node 800A heat exchangers*

(fan only - use with existing guard grill)

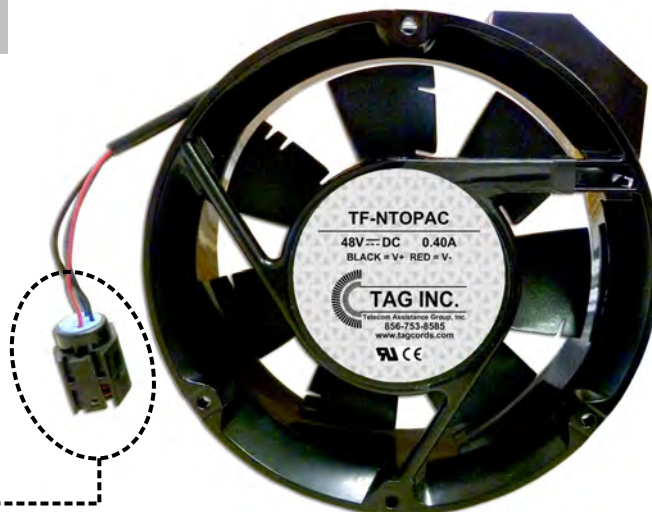

**WEATHERPROOF
 CONNECTOR
 on PN # TFNT0PAC**

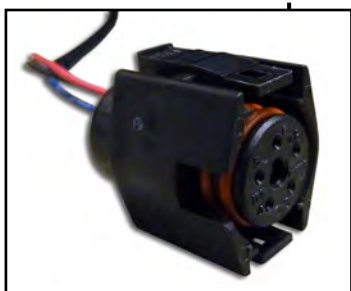

Looking for fans w/ sealed 3 pin plugs?



(PN # TFNT0PAC04 - CALL)



(WINBUY # TFNT0PAC02)

Ordering Information:

**48V Replacement Fan for Nortel Opac / OPM Cabinet
 w/ Round Weatherproof Connector**
(Replaces Nortel # A0381740 / # A33230 (-51)), Fits first generation Access Node 800A heat exchangers

**WINBUY #
 TFNT0PAC**

**48V Replacement Fan for Nortel Opac / OPM Cabinet - (not shown)
 w/ 3 Wire Open End (no connector)**
(Splicing Replacement option for both Access Node 800A & OPAC Cabinets)

TFNT0PAC3

**48V Replacement Fan for Nortel Opac / OPM Cabinet
 w/ Sealed 3 Pin Plug** *(Replaces Nortel # A0640820 / # A33230 (-51))*

TFNT0PAC02

Also Available: *(call for pricing)*

**48V Replacement Fan for Nortel Opac / OPM Cabinet
 w/ Sealed 3 Pin Plug** *(Used with NT7A6986 adapter)*

TFNT0PAC04

Guard Grill Replacement Kit for Round 162mm Fans *(includes hardware) - (not shown)*

TFG162KIT01

150 Cooper Rd. (F-15)
 W. Berlin, NJ 08091

www.tagcords.com

Telecom Assistance Group

Telephone: (856) 753-8585
 Fax : (856) 768-7645

OSP Cabinet Replacement Fans

"DMS-100 OPM BFU / DMS-1 URBAN"

(Not for use in Nortel Access Node Fan Trays)

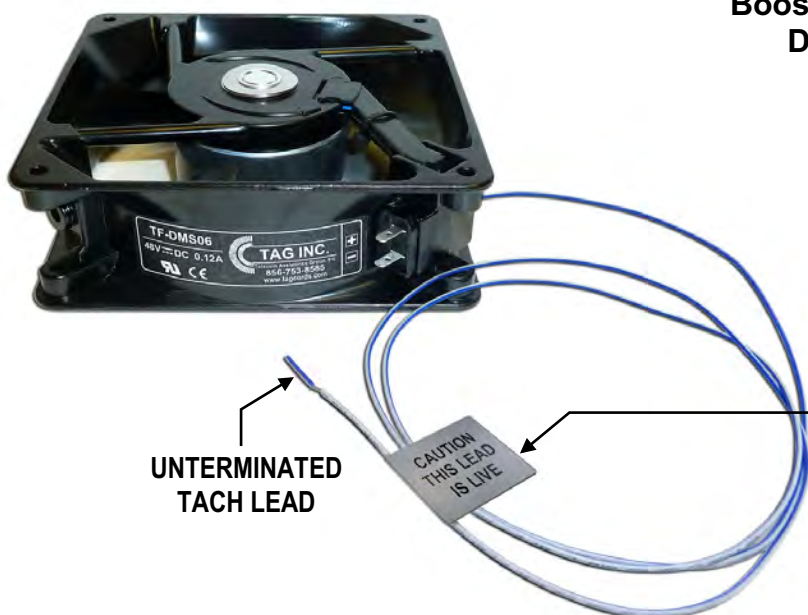

UNTERMINATED TACH LEAD

CAUTION THIS LEAD IS LIVE

CAUTION THIS LEAD IS LIVE

DO NOT REMOVE UNTIL HOOKUP

WINBUY # TFDMS06
48V Replacement Fan for
Booster Fan Unit (BFU) found in
DMS-100 OPM Cabinets

w/ Power Prongs,
Unterminated Tach Lead
& (1) Butt Splice

DMS-100 OPM CABINET BOOSTER FAN UNIT (BFU) w/ EXISTING FANS



Also used in DMS-1
URBAN EMC RT BAY
(NT4A44AA fan unit)

Ordering Information:

**48 Volt Replacement Fan for Booster Fan Unit (BFU)
found in DMS-100 OPM Cabinets**
w/ Power Prongs, Unterminated Tach Lead & (1) Butt Splice
(also used in DMS-1 URBAN EMC RT BAY (NT4A44AA fan unit))

WINBUY #
TFDMS06

150 Cooper Rd. (F-15)
W. Berlin, NJ 08091

www.tagcords.com

Telephone: (856) 753-8585
Fax : (856) 768-7645

Telecom Assistance Group

OSP Cabinet Replacement Fans & Alarm Control Boards

"Lucent 4A / 4B"

WINBUY # TFSLC201
 48 Volt Replacement Fan for
 SLC 2000 4A / 4B Fan Trays

w/ 5 Wire Plug

(Equiv. to KS23912L6)

(80 Type Cabinet,
 SLC 2000 Tray - Internal)



**SLC 2000 EQUIPMENT -
 4B FAN UNIT w/ (2) FANS**
 (fan tray is not included)

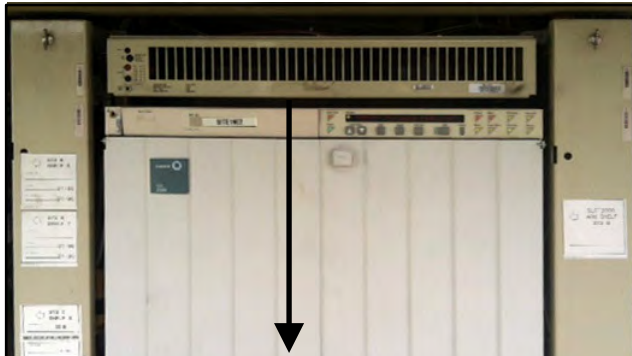

NEW Alarm Control Boards
 are also available,
 order **WINBUY # TFCLU401**



Ordering Information:

48V Fan w/ 5 Wire Plug for SLC 2000 4A / 4B Fan Trays
 (Equiv. to KS23912L6) (80 Type Cabinet, SLC 2000 Tray - Internal)

WINBUY #
TFSLC201

Alarm Control Board for 4A/4B, 4G/SLC 2000 Trays & 114A Control Units
 (control board only - customer supplied fan trays / 114A housing)

TFCLU401

150 Cooper Rd. (F-15)
 W. Berlin, NJ 08091

www.tagcords.com

Telephone: (856) 753-8585
 Fax : (856) 768-7645

Telecom Assistance Group

OSP Cabinet Heat Exchanger Fans

WINBUY # TFCLX22501

(225mm) HX Impeller Fan (**Upper**) for
Calix ODC Cabinet
w/ 4 Wire Female Snap on Plug, (14" cable)

PN # TF-CLX225-02 (call for pricing)

(225mm) HX Impeller Fan (**Upper**) for
Calix ODC Cabinet
w/ 4 Wire Female Snap on Plug, (30" cable)

PN # TF-CLX225-03 (call for pricing)

(225mm) HX Impeller Fan (**Lower**) for
Calix ODC Cabinet
w/ 4 Wire Male Snap on Plug, (30" cable)

"Calix ODC - 225mm"



*(fan only,
mounting bracket
is not included)*



(4) HEAT EXCHANGERS ARE MOUNTED IN THE HX UNITS ATTACHED TO THE DOORS

"Calix ODC - 133mm"

WINBUY # TFCLX13301
(133mm) Heat Exchanger for
Calix ODC Cabinet
w/ 4 Wire Open End*

**(includes (4) butt splices
& (1) 4 pin connector)*

*(fan only,
mounting bracket
is not included)*

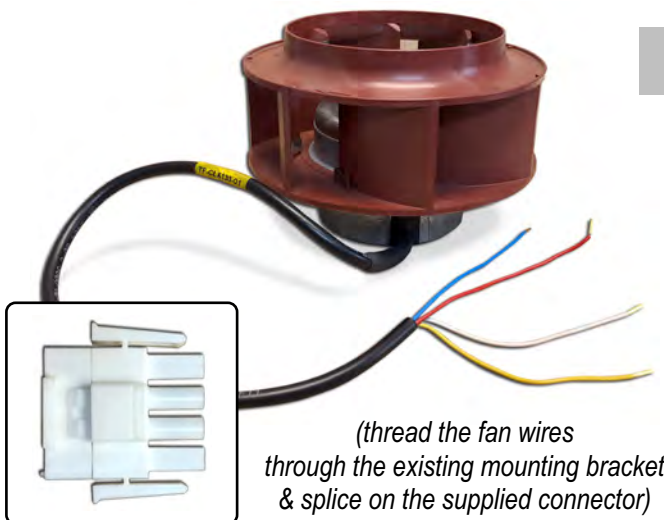

*(thread the fan wires
through the existing mounting bracket
& splice on the supplied connector)*

150 Cooper Rd. (F-15)
W. Berlin, NJ 08091

www.tagcords.com

Telephone: (856) 753-8585
Fax : (856) 768-7645

Telecom Assistance Group

Calix E7 Replacement Fans

WINBUY # TFCLXE701

12 Volt Replacement Fan for
Calix E7-2 FTA2 Fan Unit
w/ 4 Wire Plug



"Calix E7"

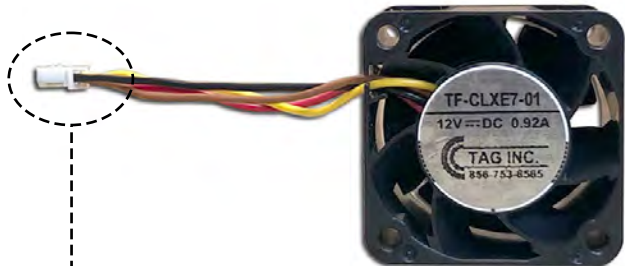

(40mm x 20mm)

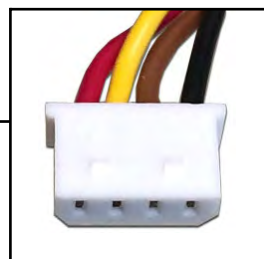

CALIX E7-2 FTA2 FAN UNIT w/ (4) EXISTING FANS *(fan unit is not included)*



Ordering Information:

12V (40mm x 20mm) Replacement Fan for
Calix E7-2 FTA2 Fan Unit w/ 4 Wire Plug

WINBUY #

TFCLXE701

150 Cooper Rd. (F-15)
W. Berlin, NJ 08091

www.tagcords.com

Telephone: (856) 753-8585
Fax : (856) 768-7645

Telecom Assistance Group

OSP Cabinet Heat Exchanger Fans



"Adtran TA5000 - Low Profile"

WINBUY # TFTA5KHX02
48V (Low Profile) Heat Exchanger for
Adtran TA5000 Cabinet Door

w/ 4 Wire Plug

(fan only, use with existing guard grill)

ADTRAN TA5000 CABINET DOOR (3 HEAT EXCHANGERS)



Ordering Information:

48 Volt (Low Profile) Replacement Heat Exchanger
for Adtran TA5000 Cabinet Door w/ 4 Wire Plug

WINBUY #
TFTA5KHX02

150 Cooper Rd. (F-15)
W. Berlin, NJ 08091

www.tagcords.com

Telephone: (856) 753-8585
Fax : (856) 768-7645

Telecom Assistance Group

***** NEW *** 5ESS "Pre-Charge" Tool**

T-5ESSPCT

**5ESS Fuse Bay Control Panel,
Lucent # ED-83024-30**

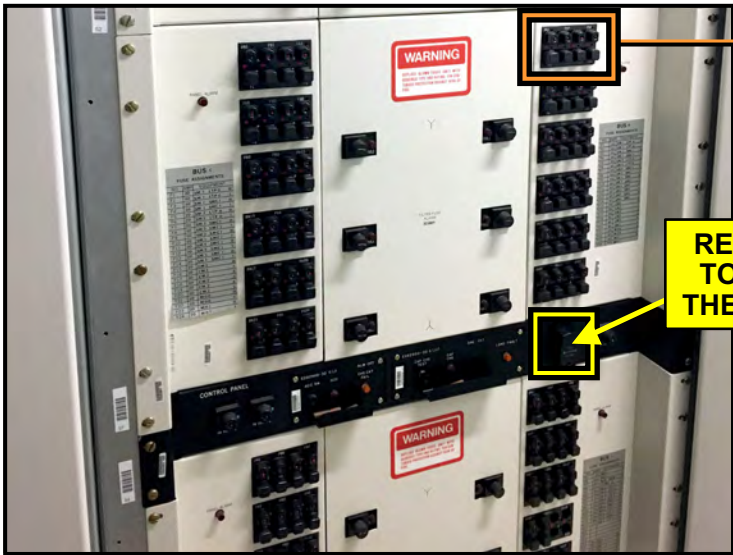

**REPLACES BROKEN
TOOL LOCATED ON
THE CONTROL PANEL**

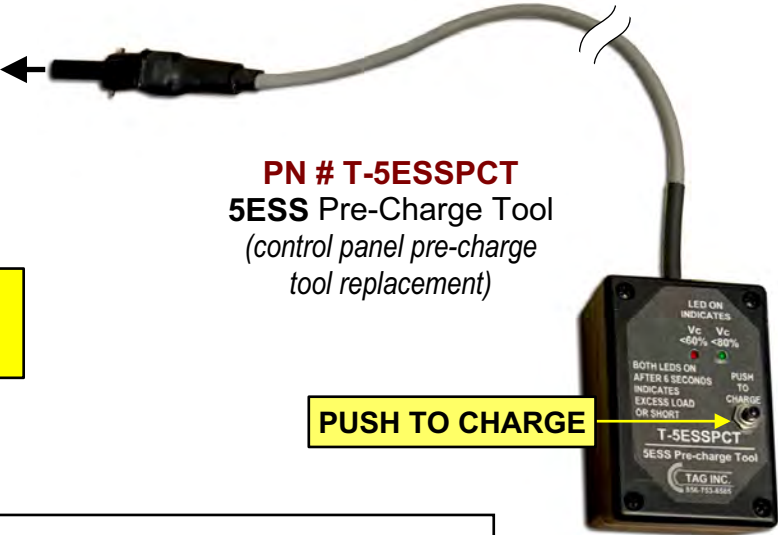

PN # T-5ESSPCT
5ESS Pre-Charge Tool
*(control panel pre-charge
tool replacement)*

PUSH TO CHARGE

1. INSERT PROBE (ALARM FUSE)
2. PRESS TEST BUTTON
3. RED & GRN LEDS WILL LIGHT
4. 4-6 SEC LEDS WILL GO OUT
5. INSTALL MAIN FUSE
6. IF RED LED STAYS ON EXCESS LOAD OR SHORT IS PRESENT

Application:

TAG's PN # T-5ESSPCT is used to pre-charge shelf power capacitors of a 5ESS switch. This allows a new fuse to be installed without seeing full in-rush surge current. The indicator light goes out when it is safe to install the fuse.

Ordering Information:

T-5ESSPCT	5ESS "Pre-Charge" Tool for Capacitor Charging at Main Fuse Bay <i>(control panel pre-charge tool replacement)</i>	Call for Pricing
------------------	-----------------------------------------------------------------------------------------------------------------------------	-------------------------

150 Cooper Rd. (F-15)
W. Berlin, NJ 08091

www.tagcords.com
Telecom Assistance Group

Telephone: (856) 753-8585
Fax : (856) 768-7645

TAG Fiber Streakers

**Fiber Streakers
for 2.5mm (TFS208)
& 1.25mm (TFS210)
Connectors - Including
SC, ST, FC & LC**

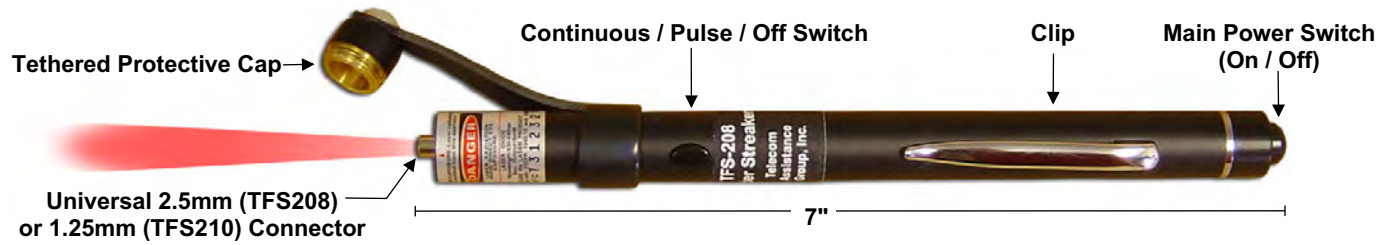

- ▶ Available with 2.5mm (TFS208) & 1.25mm (TFS210) receptacles for singlemode and multimode fibers
- ▶ The TFS208 accepts any connector with a 2.5mm ferrule including SC, ST & FC connectors
- ▶ The TFS210 accepts any connector with a 1.25mm ferrule including LC connectors
- ▶ Continuous and pulsed operation modes ▶ High visibility up to 3 km ▶ 650 nm laser output

Ordering Information:	WINBUY #
Tag Fiber Streaker (2.5mm) - includes: (1) carrying case & (2) AAA batteries	TFS208
Tag Fiber Streaker (1.25mm) - includes: (1) carrying case & (2) AAA batteries	TFS210

150 Cooper Rd. (F-15)
W. Berlin, NJ 08091

www.tagcords.com
Telecom Assistance Group

Telephone: (856) 753-8585
Fax : (856) 768-7645

Fiber Optic Test Cord Kit

FOTCKIT

Fiber Optic Test Cords Included in Kit:

Carrying Case included with Kit

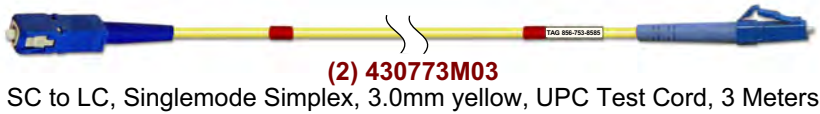
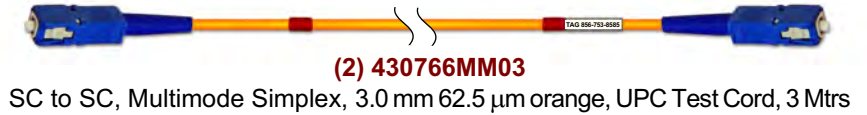
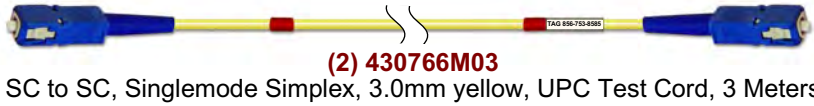

Fiber Optic Adapters Included in Kit:



- | | | | |
|-----------------------------------------------------------------------------|------------------------------------------------------------------------------|----------------------------------------------------------|------------------------------------------------------------------------------|
| (1) WINBUY #
400766C
SC to SC
Simplex
UPC Coupler | (1) WINBUY #
400766AC
SC to SC
Simplex
APC Coupler | (1) 400781C
LC to LC
Simplex
UPC Coupler | (1) WINBUY #
400781AC
LC to LC
Simplex
APC Coupler |
|-----------------------------------------------------------------------------|------------------------------------------------------------------------------|----------------------------------------------------------|------------------------------------------------------------------------------|



- | | | |
|----------------------------------------------------------|----------------------------------------------------------|----------------------------------------------------------|
| (1) 400758C
ST to ST
Simplex
UPC Coupler | (1) 400752C
FC to FC
Simplex
UPC Coupler | (1) 400756C
D4 to D4
Simplex
UPC Coupler |
|----------------------------------------------------------|----------------------------------------------------------|----------------------------------------------------------|



Ordering Information:

Fiber Optic Test Cord Kit

includes: (20) Test Cords, (7) Adapters & (1) Carrying Case

WINBUY #
FOTCKIT

150 Cooper Rd. (F-15)
W. Berlin, NJ 08091

www.tagcords.com

Telecom Assistance Group

Telephone: (856) 753-8585
Fax: (856) 768-7645