

# Uniti - UBuy

## 2026 Product Ordering Guide

[Issue 1.0](#)

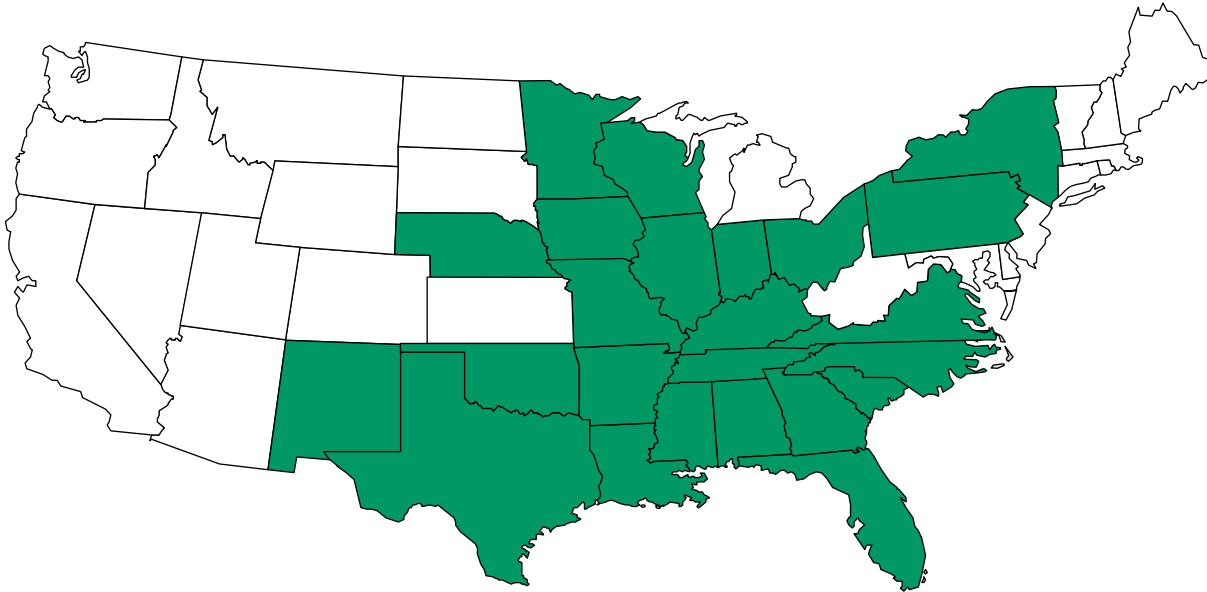

Provided By:



*The "Cord Company" and more . . .*

### "TEST CORDS & ADAPTERS"

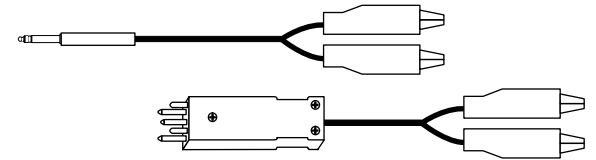

### "FIBER OPTIC CORDS, KITS, COUPLERS & STREAKERS (VFLs)"

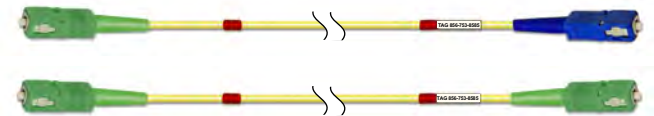

### "SWITCH & TRANSPORT TERMINALS"

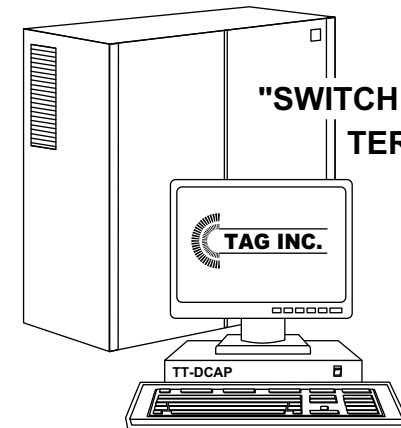

### "CO & OSP FANS"

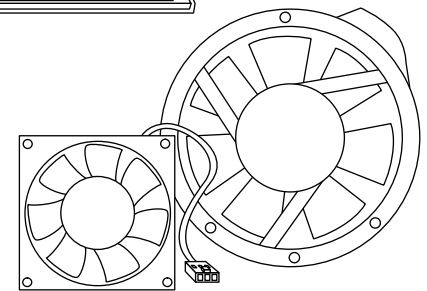

[www.tagcords.com](http://www.tagcords.com)

-

**856-753-8585**

# TAG DMS-100 3X9013 Universal Fan Tray

# TFT-3X9013T

## Universal 48VDC Fan Tray

### - No 24VAC Inverters

(24VAC inverters cause heat concerns & major equipment failures)

### - No Mechanical Sensors

(sensor paddles are known to bend & break)

INSTALLATION VIDEOS:



NT3X90AA/AB



NT3X90AC



NT3X90AF

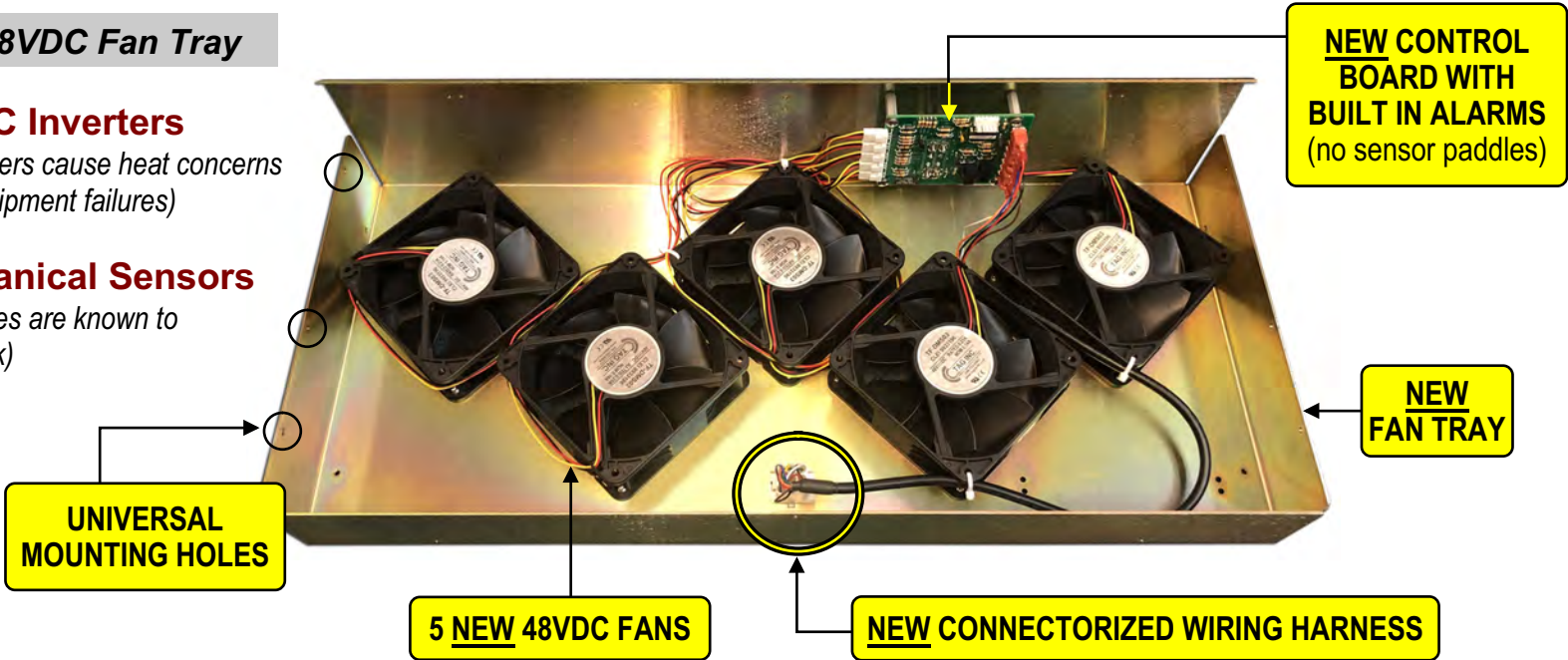

- Connectorized Universal metal tray with Fan Alarm Board (no sensor paddles)
- Pre-assembled & works with NT3X90AA, NT3X90AB, NT3X90AC & NT3X90AF Cooling Units
- Adapter cables\* are supplied for NT3X90AA/AB & NT3X90AF Cooling Units  
\*(adapter cables are not used with NT3X90AC)

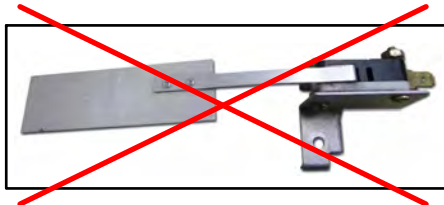

**Ordering Information:**

**TAG Universal DMS-100 3X9013 Fan Tray**  
 Includes: (1) Brand New Fan Tray w/ Universal Mounting Holes,  
 (5) TF-DMS03, 48VDC Fans w/ TTL Tach & 3 Wire Plug,  
 (1) Fan Control Board w/ Built in Sensors (no paddles needed), Wiring Labels, Mounting Hardware,  
 (1) Wiring Harness w/ Connector, NT3X90AA/AB & NT3X90AF Adapter Cables & Installation Guide



**WINBUY #**  
**TFT3X9013T**

150 Cooper Rd. (F-15)  
W. Berlin, NJ 08091

www.tagcords.com  
**Telecom Assistance Group**

Telephone: (856) 753-8585  
Fax: (856) 768-7645

# WINDSTREAM

FEATURES / APPLICATION	WINBUY #	LENGTH	DESCRIPTION
<p><b>SC to SC, Singlemode Duplex, 2.0mm yellow, UPC</b></p> <ul style="list-style-type: none"> <li>SINGLEMODE: Link between bulkhead adapters and terminal equipment</li> </ul>	<p><b>400766DM05 400766DM10</b></p>	<p><b>(5 mtrs) (10 mtrs)</b></p>	<p><b>SC to SC, SINGLEMODE DUPLEX, UPC TEST CORD</b></p> 
<p><b>SC to ST, Singlemode Duplex, 2.0mm yellow, UPC</b></p> <ul style="list-style-type: none"> <li>SINGLEMODE: Link between bulkhead adapters and terminal equipment</li> </ul>	<p><b>400771DM05 400771DM10</b></p>	<p><b>(5 mtrs) (10 mtrs)</b></p>	<p><b>SC to ST, SINGLEMODE DUPLEX, UPC TEST CORD</b></p> 
<p><b>SC to SC, OSP Singlemode Simplex, 2.0mm yellow, APC</b></p> <ul style="list-style-type: none"> <li>SINGLEMODE: Link between bulkhead adapters and terminal equipment</li> </ul>	<p><b>400766AA0SP01</b></p>	<p><b>(1 ft)</b></p>	<p><b>SC to SC, SINGLEMODE SIMPLEX, APC TEST CORD</b></p> 

## DB9M / RS232 to USB Adapter Cable

**Need access to a Serial Port on your Laptop?**

**TAG's Adapter Cable will convert your Laptop's USB Port into a Serial Port!**

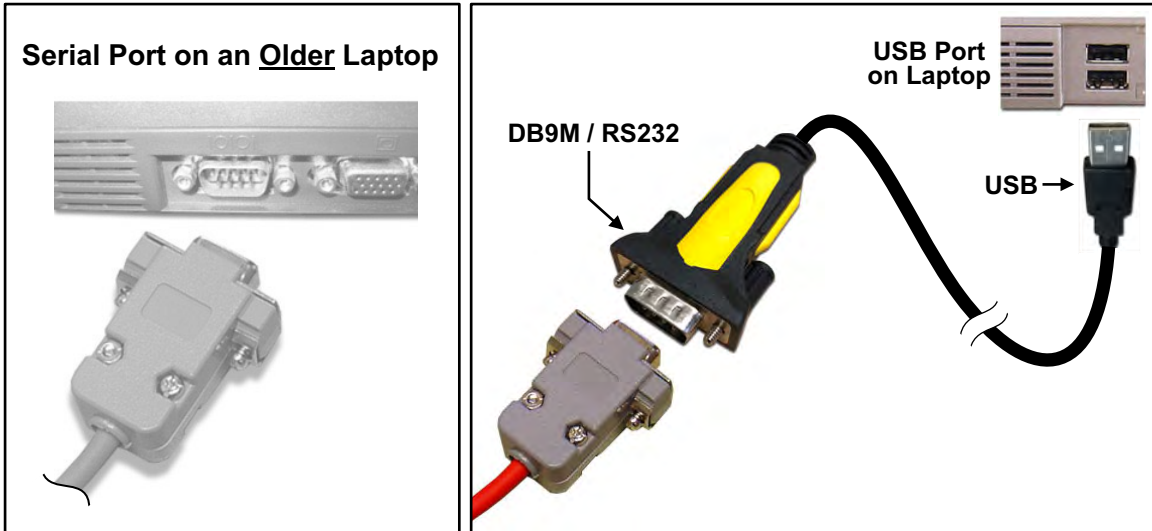

### System Requirements:

- Supports Windows® 2000 / XP / Server 2008 / Vista / 7 / 8 / 10
- Available USB Port

### Application:

Plug the USB connector into your computer and the serial connector into your serial device to exchange files, data and more.



### Ordering Information:

**DB9M/RS232 to USB Adapter Cable**

*Supports Windows® 2000 / XP / Server 2008 / Vista / 7 / 8 / 10*

**WINBUY #  
400720USB**

150 Cooper Rd. (F-15)  
W. Berlin, NJ 08091

[www.tagcords.com](http://www.tagcords.com)

**Telecom Assistance Group**

Telephone: (856) 753-8585

Fax: (856) 768-7645

## Business Class Network Interface Device (NID)

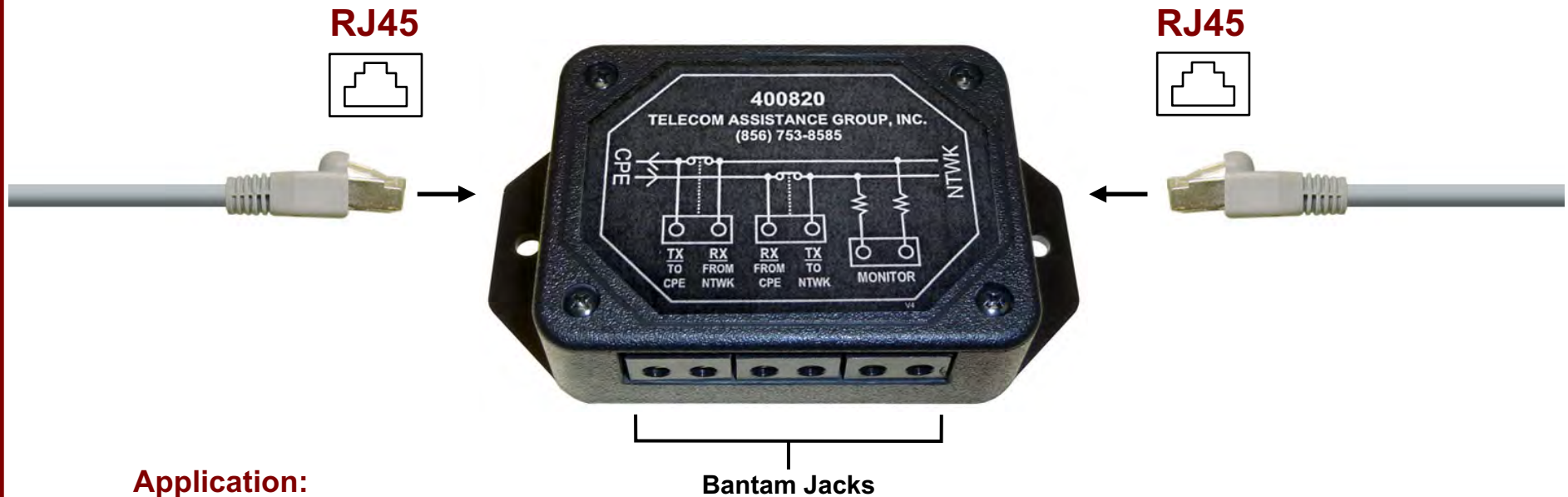

### Application:

- ▶ One unit per T1 is required and is installed between the VGW and the customer PBX by the Business Class provider.
- ▶ The 400820 (NID) provides an input (Network) RJ45 port to connect the VGW to the NID. *The Business Class provider will be responsible for providing the connection from the VGW to the 400820 (NID).*
- ▶ An RJ45 port (CPE) provides Business Class customers a connection from PRI and the CPE PBX. *This connection is the customer's responsibility.*
- ▶ Bantam test ports are located on the bottom of the 400820 (NID) for future maintenance and performance testing connected to the preferred test set.



**Ordering Information:**  
**T1 Monitor Box**

**WINBUY #**  
**400820**

150 Cooper Rd. (F-15)  
 W. Berlin, NJ 08091

www.tagcords.com  
**Telecom Assistance Group**

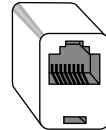
Telephone: (856) 753-8585  
 Fax : (856) 768-7645

FEATURES / APPLICATION	WINBUY #	DESCRIPTION
<p><b>Cat 5 Cable (RJ45 to RJ45)</b></p> <ul style="list-style-type: none"> <li>Standard CAT5 Cable</li> </ul>	<p>RHCAT505 RHCAT510 RHCAT515 RHCAT520 RHCAT525 RHCAT530 RHCAT540 RHCAT550</p>	<p style="text-align: center;"><u><b>LENGTH</b></u></p> <p style="text-align: center;">(5') (10') (15') (20') (25') (30') (40') (50')</p> <p><b>CAT 5 CABLES (RJ45 to RJ45) ( @ various lengths )</b></p> 
<p><b>RJ45/48 Coupler</b></p> <ul style="list-style-type: none"> <li>General purpose coupler adapter</li> </ul>	<p><b>RJ48C</b></p>	<p><b>RJ45/48 COUPLER</b></p> 
<p><b>DMX Provisioning (CAT5E) Cross-Over Cable, (10')</b></p> <ul style="list-style-type: none"> <li>Cable for testing Lucent's DMX Platforms with the CAT5E Ethernet Cable. The CAT5E cable is designed to work with Windows XP operating systems.</li> </ul>	<p><b>400448XP10</b></p>	<p><b>DMX CROSS-OVER CABLE</b></p> 
<p><b>RJ45/48 to DB 9 Pin (male), (6')</b></p> <ul style="list-style-type: none"> <li>RJ45 to DB 9 Pin (male) typically used for provisioning</li> </ul>	<p><b>RHCU720M</b></p>	<p><b>RJ45/48 to 9 PIN (male)</b></p> 

# Remote Network Cable Tester w/ Tone Generator

# CAT107G

## Simplify Network Cable Testing !!

### Cable Test Features:

- Displays:**
- Short
  - Reversed
  - Miswired
  - Split Pairs

### Tone Generator\* Features:

- Verification of Shield Integrity
- Puts Tracer Tone on Cable

\* Tone Generator function requires customer supplied Cable Tracing Probe

### Additional Features:

- Specially designed Remote Unit that enables one person to test installed cables
- Easy to read Fault Display and high speed testing
- Debug mode for detailed fault identification results
- Auto Sleep Mode and Power Off Switch to decrease power consumption
- Low Battery Indicator
- Includes (4) four AAA batteries

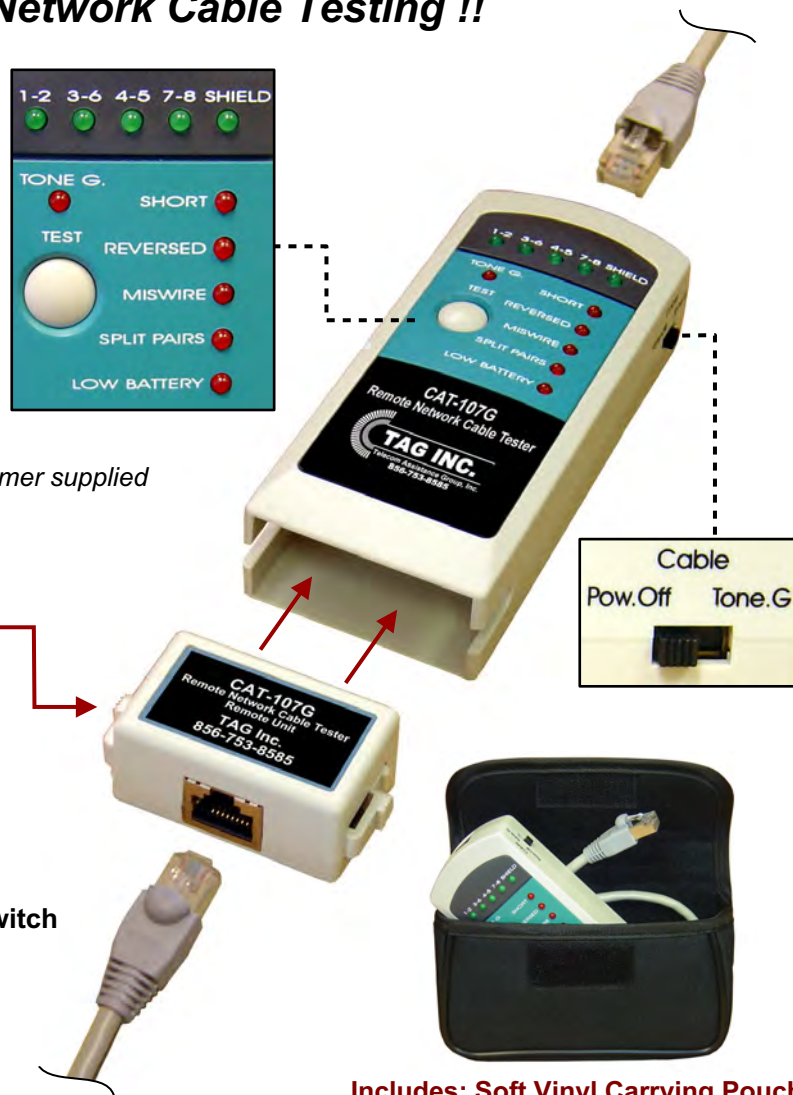

**Includes: Soft Vinyl Carrying Pouch & Remote Terminating Cable**

### Application:

The CAT107G is a small hand-held cable tester, which enables network professionals to quickly and easily verify the integrity of ethernet twisted pair cables for open pairs, shorted pairs, reversed pairs, crossed pairs and split pairs. Push the TEST button and the CAT107G will automatically scan for any existing faults in your cable. The specially designed remote terminator is provided for one-person testing of installed cables. The tone generator function can be used to send a signal through installed cables which can be traced with most cable tracers on the market.

### Ordering Information:

#### **Remote Network Cable Tester w/ Tone Generator**

includes: (1) Carrying Pouch, (1) Remote Terminating Cable & (4) AAA Batteries

### WINBUY #

**CAT107G**





150 Cooper Rd. (F-15)  
W. Berlin, NJ 08091





[www.tagcords.com](http://www.tagcords.com)

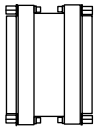

**Telecom Assistance Group**

Telephone: (856) 753-8585

Fax : (856) 768-7645

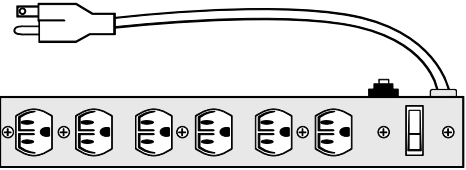
FEATURES / APPLICATION	WINBUY #	DESCRIPTION
<p><b>DB 9 Pin (male) to DB 25 Pin (female), (6')</b></p> <ul style="list-style-type: none"> <li>9 Pin to 25 Pin conversion cable</li> </ul>	<b>400725</b>	<p><b>9 PIN (male) to 25 PIN (female)</b></p> 
<p><b>DB 9 Pin (male) to DB 9 Pin (female), (6')</b></p> <ul style="list-style-type: none"> <li>Commonly used from Laptop to test at Pair Gain (HDSL)</li> <li>Wired straight</li> </ul>	<b>400720</b>	<p><b>9 PIN (male) to 9 PIN (female)</b></p> 
<p><b>DB 25 Pin (male) to DB 25 Pin (female), (6')</b></p> <ul style="list-style-type: none"> <li>Standard Serial Printer Cable, (25 Wires)</li> </ul>	<b>400706</b>	<p><b>25 PIN (male) to 25 PIN (female)</b></p> 
<p><b>DB 9 Pin (female) to 25 Pin (male), (6')</b></p> <ul style="list-style-type: none"> <li>IBM AT COM1 Computer Cable</li> </ul>	<b>400703</b>	<p><b>9 PIN (female) to 25 PIN (male)</b></p> 
<p><b>HDSL Provisioning Test Cord</b></p> <ul style="list-style-type: none"> <li>DB 25 Pin (male) to DB 9 Pin (male) for HDSL provisioning from "Dumb" terminals</li> </ul>	<p><b>400703H10</b> (10')  <b>400703H25</b> (25')</p>	<p><b>HDSL PROVISIONING TEST CORD</b></p> 

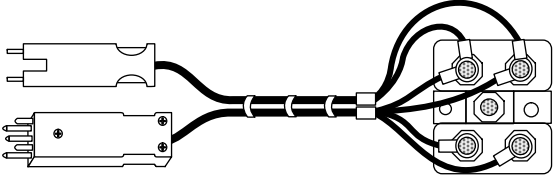
FEATURES / APPLICATION	WINBUY #	DESCRIPTION
<p><b>DB 25 Pin (male) to (male) Gender Changer</b></p> <ul style="list-style-type: none"> <li>Standard Serial Gender Changer</li> </ul>	400701	<p><b>25 PIN (male) to 25 PIN (male) GENDER CHANGER</b></p> 
<p><b>DB 9 Pin (male) to DB 9 Pin (male) Adapter</b></p> <ul style="list-style-type: none"> <li>9 Pin Adapter - Gender Changer</li> </ul>	400709M	<p><b>9 PIN (male) to 9 PIN (male) ADAPTER</b></p> 
<p><b>DB 9 Pin (female) to DB 9 Pin (female) Gender Changer</b></p> <ul style="list-style-type: none"> <li>9 Pin Adapter - Gender Changer</li> </ul>	400709F	<p><b>9 PIN (female) to 9 PIN (female) GENDER CHANGER</b></p> 
<p><b>DB 9 Pin (male) to DB 9 Pin (female) "Null Adapter"</b></p> <ul style="list-style-type: none"> <li>Null Adapter</li> </ul>	400709N	<p><b>9 PIN (male) to 9 PIN (female) "NULL" ADAPTER</b></p> 
<p><b>UL Surge Suppressor Outlet Power Strip</b></p> <ul style="list-style-type: none"> <li>6 outlets with 15A breakout</li> </ul>	400704	<p><b>SURGE SUPPRESSOR - OUTLET POWER STRIP</b></p> 

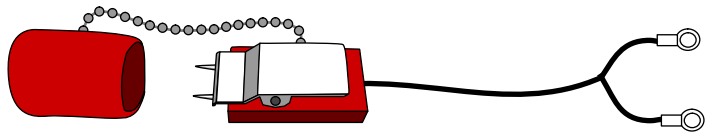
FEATURES / APPLICATION	WINBUY #	DESCRIPTION
<p><b>Protector/526A plug to 125 Station Protector, (10')</b></p> <ul style="list-style-type: none"> <li>Cabinet mounting assembly for performing line tests on SLC-96 &amp; Series 5</li> </ul>	<p><b>T6W3F10</b></p>	<p><b>PROTECTOR/526A to STATION PROTECTOR</b></p> 
<p><b>Wire Wraps to Mini Alligator Clips, (4')</b></p> <ul style="list-style-type: none"> <li>Slides on wire wraps</li> <li>Alligator Clip connections to butt sets, Caller ID, etc.</li> </ul>	<p><b>400200MA04</b></p>	<p><b>WIRE WRAPS to MINI ALLIGATOR CLIPS</b></p> 
<p><b>RJ48 to 6P Alligator Clips, (6')</b></p> <ul style="list-style-type: none"> <li>Test cord used from TPI (ISDN) test set (RJ48 - ISDN) to Alligator Clips</li> <li>Pin 4 - Ring/Pin 5 - Tip (RJ48)</li> </ul>	<p><b>400448AP2</b></p>	<p><b>RJ48 to 6P ALLIGATOR CLIPS</b></p> 
<p><b>RLS Plug to Round Lugs, (8')</b></p> <ul style="list-style-type: none"> <li>Used for testing Reltec Systems</li> </ul>	<p><b>400196KIT2</b></p>	<p><b>RLS PLUG to ROUND LUGS</b></p> 

# The "Multi" Cord

## Butt-In Connectors

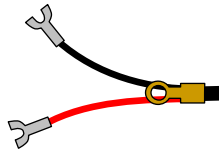

**1** **Hardwire (Standard)**

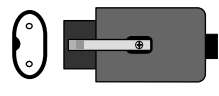

**2** **471A Jack (Quick Disconnect)**

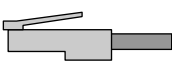

**3** **Modular**  
 3A.) 4 Position, 2 conductor  
 3B.) 6 Position, 2 conductor  
 3C.) 8 Position, 2 conductor



**4** **Hardwire (Weatherproof)**

## ORDERING SAMPLE









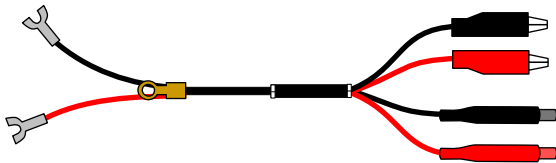

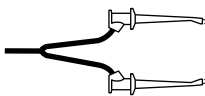
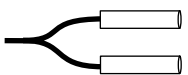
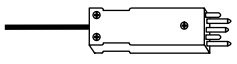
Butt-In	Plugs			Length
<b>1</b>	<b>A</b>	<b>C</b>	<b>-</b>	<b>6</b>

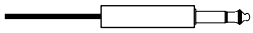
Choose (1 to 4 Ends)

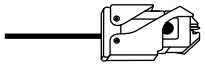
**WINBUY # 1AC6**

Hardwire to Alligators / Wire Wraps, (6')

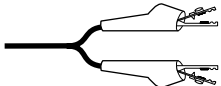
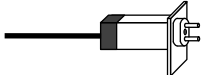
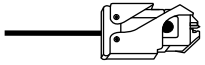

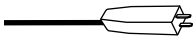
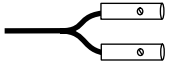
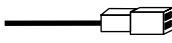
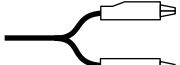
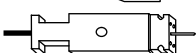



Alligator	<b>A</b>	
Mini Test	<b>B</b>	
Wire Wrap	<b>C</b>	
Protector	<b>D</b>	
453A	<b>E</b>	
Bantam	<b>F</b>	
310	<b>G</b>	
526A	<b>H</b>	
88 Type (D Clip)	<b>I</b>	
526P (Porta)	<b>J</b>	
Snagless RJ11	<b>K</b>	
SLC 96	<b>L</b>	
Modular (RJ11)	<b>M</b>	
6P Alligator	<b>O</b>	
310 MDF	<b>P</b>	
110 Clip (C Clip)	<b>Q</b>	
76 Clip	<b>R</b>	
SLC 5	<b>S</b>	
360 Tools	<b>T</b>	
66 Blk Adapter	<b>X</b>	
Mini Alligator	<b>Y</b>	
Porta	<b>Z</b>	





150 Cooper Rd. (F-15)  
 W. Berlin, NJ 08091





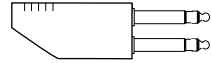

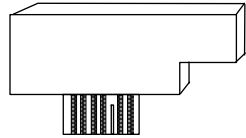
[www.tagcords.com](http://www.tagcords.com)

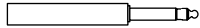

**Telecom Assistance Group**

Telephone: (856) 753-8585  
 Fax : (856) 768-7645



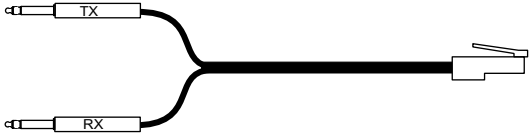

FEATURES / APPLICATION	WINBUY #	DESCRIPTION
<p><b>526A plug to Alligator Clips, (6')</b></p> <ul style="list-style-type: none"> <li>Monitor access to Protectors via test points without pulling Protector</li> <li>Equivalent to P2FL</li> </ul>	400526A	<p><b>526A PLUG to ALLIGATOR CLIPS</b></p> 
<p><b>453A plug to Alligator Clips, (3')</b></p> <ul style="list-style-type: none"> <li>Used to short the tip and ring or to ground the tip and/or ring</li> <li>Plugs to recessed terminals on 300 series connectors (except 310)</li> <li>Equivalent to P2EF</li> </ul>	400430	<p><b>453A PLUG to ALLIGATOR CLIPS</b></p> 
<p><b>Dual Push Pins (310 MDF) to Alligator Clips, (3')</b></p> <ul style="list-style-type: none"> <li>Used to short the tip and ring or to ground the tip and/or ring</li> <li>Plugs to recessed terminals on 310 series connectors</li> <li>Equivalent to P2FM</li> </ul>	400426	<p><b>DUAL PUSH PINS to ALLIGATOR CLIPS</b></p> 
<p><b>Protector (non-bridging) to Alligator Clips, (8')</b></p> <ul style="list-style-type: none"> <li>Test access at coils</li> </ul>	400300S	<p><b>PROTECTOR to ALLIGATOR CLIPS</b></p> 
<p><b>Protector to Alligator Clips, (3')</b></p> <ul style="list-style-type: none"> <li>Test access at MDF (coils)</li> </ul>	400300C3	<p><b>PROTECTOR to ALLIGATOR CLIPS</b></p> 

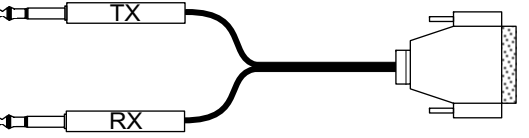
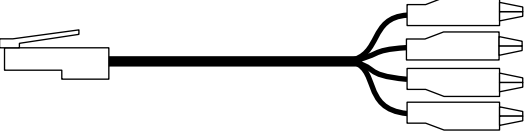

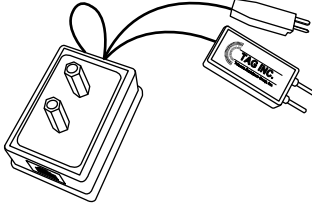
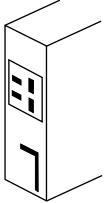
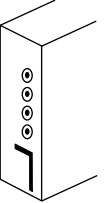
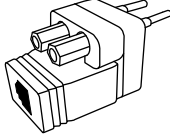
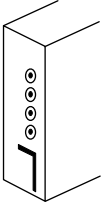
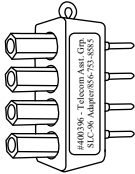
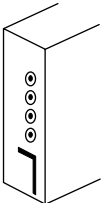
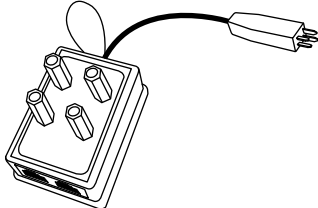
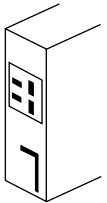
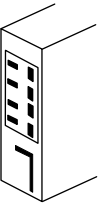
FEATURES / APPLICATION	WINBUY #	DESCRIPTION
<p><b>Bantam Looping Plug</b></p> <ul style="list-style-type: none"> <li>3 conductor looping plug</li> </ul>	400210LP	<p><b>BANTAM LOOPING PLUG</b></p> <div style="text-align: center; margin-top: 10px;">  </div>
<p><b>MDF Shorting cord</b></p> <ul style="list-style-type: none"> <li>453A plug looped</li> <li>Used at 303, 304, and 308 MDF frames</li> </ul>	400430L	<p><b>MDF SHORTING CORD</b></p> <div style="text-align: center; margin-top: 10px;">  </div>
<p><b>SLC-96 Looping Plug</b></p> <ul style="list-style-type: none"> <li>Loops SLC-96 circuits at the LIU</li> </ul>	400396L	<p><b>SLC 96 LOOPING PLUG</b></p> <div style="text-align: center; margin-top: 10px;">  </div>
<p><b>15 Pin (female) to LIU "low profile" connector, (8')</b></p> <ul style="list-style-type: none"> <li>Connects Power Panel to LIU for test jack access</li> <li>"Low Profile" allows greater door clearance at SLC cabinets</li> </ul>	400442FL	<p><b>15 PIN to LIU</b></p> <div style="text-align: center; margin-top: 10px;">  </div>
<p><b>Bantam Terminating Plug</b></p> <ul style="list-style-type: none"> <li>100 ohm Terminating Plug</li> </ul>	B004210TP100	<p><b>BANTAM TERMINATING PLUG</b></p> <div style="text-align: center; margin-top: 10px;">  </div>

FEATURES / APPLICATION	WINBUY #	DESCRIPTION
<p><b>Bantam to Bantam, (6') (RED)</b>  <b>Bantam to Bantam, (6') (BLACK)</b></p> <ul style="list-style-type: none"> <li>Patching or Test Set Application</li> <li>Red / Black colors for Transmit / Receive</li> </ul>	<p><b>400210RD06</b>  <b>400210BK06</b></p>	<p><b>BANTAM to BANTAM - RED</b>  <b>BANTAM to BANTAM - BLACK</b></p> 
<p><b>Dual Bantam to Dual Bantam, (10')</b>  <b>Dual Bantam to Dual Bantam, (20')</b>  <b>Dual Bantam to Dual Bantam, (42')</b></p> <ul style="list-style-type: none"> <li>Patch cord</li> </ul>	<p><b>400210DD10</b>  <b>400210DD20</b>  <b>400210DD42</b></p>	<p><b>DUAL BANTAM to DUAL BANTAM</b></p> 
<p><b>Dual Bantam to Mini Test Clips, (6')</b></p> <ul style="list-style-type: none"> <li>"Mini Grabbers" excellent for access to various connectors, wire terminals</li> </ul>	<p><b>400210DT</b></p>	<p><b>DUAL BANTAM to MINI TEST CLIPS</b></p> 
<p><b>Bantam to Mini Test Clips, (6')</b></p> <ul style="list-style-type: none"> <li>"Mini Grabbers" excellent for access to various connectors, wire terminals</li> </ul>	<p><b>400210TTELE</b></p>	<p><b>BANTAM to MINI TEST CLIPS</b></p> 
<p><b>Bantam to Wire Wrap Terminals, (6')</b></p> <ul style="list-style-type: none"> <li>Slides on standard CO terminal block pins (.045) for test access</li> </ul>	<p><b>400210WP</b></p>	<p><b>BANTAM to WIRE WRAP TERMINALS</b></p> 
<p><b>Bantam to (2) Alligator Clips, (6')</b></p> <ul style="list-style-type: none"> <li>Access to various connectors, bare cable</li> </ul>	<p><b>400210A</b></p>	<p><b>BANTAM to ALLIGATOR CLIPS</b></p> 
<p><b>Bantam to 310 Conversion Plug</b></p> <ul style="list-style-type: none"> <li>Slides over bantam plug converting it to a 310</li> </ul>	<p><b>400239BST</b></p>	<p><b>BANTAM TO 310 CONVERSION PLUG</b></p>  <p style="text-align: center;">BANTAM      400239BST</p>

FEATURES / APPLICATION	WINBUY #	DESCRIPTION
<p><b>Bantam "Y" (Tx &amp; Rx) to RJ48C- (T1), (8')</b></p> <ul style="list-style-type: none"> <li>Commonly used to Transmit (TX) and Receive (RX) from T1 tests</li> <li>The RJ48C plugs into the faceplate of T1 cards allowing test access</li> </ul>	40024808	<p><b>BANTAM "Y" to RJ48C, (8')</b></p>  <p>The diagram shows a cable with two Bantam Y connectors on one end, labeled TX and RX, and a single RJ48C connector on the other end.</p>
<p><b>Bantam "Y" (Tx &amp; Rx) to RJ48S - (DDS), (8')</b></p> <ul style="list-style-type: none"> <li>Commonly used to Transmit (TX) and Receive (RX) from DDS tests</li> <li>The RJ48S plugs into the faceplate of DDS cards allowing test access</li> </ul>	400248S	<p><b>BANTAM "Y" to RJ48S, (8')</b></p>  <p>The diagram shows a cable with two Bantam Y connectors on one end, labeled TX and RX, and a single RJ48S connector on the other end.</p>
<p><b>310 "Y" (Tx &amp; Rx) to 15 Pin D (male), (4')</b></p> <ul style="list-style-type: none"> <li>3101596</li> <li>Commonly used to Transmit (TX) and Receive (RX) from Customer Service Unit (CSU) from T1 test sets</li> <li>Also used with T1 power lids</li> </ul>	400315M04	<p><b>310 "Y" to 15 PIN D (male), (4')</b></p>  <p>The diagram shows a cable with two Bantam Y connectors on one end, labeled TX and RX, and a 15-pin D-sub connector on the other end.</p>
<p><b>RJ48 (T1) to 4 Alligator Clips, (6')</b></p> <ul style="list-style-type: none"> <li>597243</li> <li>Alligator Clip Access to RJ48 (Pins 1,2,4,5)</li> </ul>	400448A406	<p><b>RJ48 (T1) to 4 ALLIGATOR CLIPS, (6')</b></p>  <p>The diagram shows a cable with a single RJ48 connector on one end and four alligator clips on the other end.</p>

FEATURES / APPLICATION	WINBUY #	DESCRIPTION
<p><b>"The SLICK CORD", (2')</b></p> <ul style="list-style-type: none"> <li>Dual Purpose cord for Series 5/SLC 2000 and/or SLC-96/DISC*S faceplate access</li> </ul>	4003956	<p><b>"SLICK CORD"</b></p> <div style="display: flex; align-items: center; justify-content: space-around;">  <div style="text-align: center;">  <p>Series 5</p>  <p>SLC-96</p> </div> </div>
<p><b>SLC-96 Line Adapter</b></p> <ul style="list-style-type: none"> <li>Hollow post and/or modular access to Odd/Even Channels at faceplate of SLC-96/DISC*S</li> </ul>	4003962M	<p><b>SLC-96 LINE ADAPTER</b></p> <div style="display: flex; align-items: center; justify-content: space-around;">  <div style="text-align: center;">  <p>SLC-96</p> </div> </div>
<p><b>SLC-96 Line Adapter</b></p> <ul style="list-style-type: none"> <li>Hollow post access to Odd/Even Channels at faceplate of SLC-96/DISC*S channel units</li> </ul>	400396	<p><b>SLC-96 LINE ADAPTER</b></p> <div style="display: flex; align-items: center; justify-content: space-around;">  <div style="text-align: center;">  <p>SLC-96</p> </div> </div>
<p><b>SLC Series 5 Test Cord, (3')</b></p> <ul style="list-style-type: none"> <li>Hollow post (Alligator Clip access) and/or modular (RJ11) access to Odd/Even channels</li> <li>Dial tone access at faceplate of Series 5 or SLC 2000</li> </ul>	400395	<p><b>SLC SERIES 5 TEST CORD</b></p> <div style="display: flex; align-items: center; justify-content: space-around;">  <div style="text-align: center;">  <p>Series 5</p>  <p>SLC 2000</p> </div> </div>

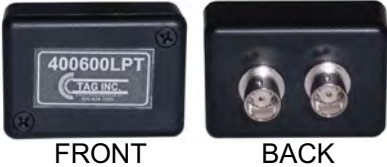
FEATURES / APPLICATION	WINBUY #	DESCRIPTION
<p><b>440A to 440A, (6') - Black</b>  <b>440A to 440A, (6') - Red</b></p> <ul style="list-style-type: none"> <li>Coax Patch / Test Cord</li> <li>Available in various lengths</li> </ul>	<p><b>400440ABK</b>  <b>400440ARD</b></p>	<p><b>440A to 440A</b></p> 
<p><b>440A to BNC, (6') - Black</b>  <b>440A to BNC, (6') - Red</b></p> <ul style="list-style-type: none"> <li>Coax Test Cord</li> <li>Available in various lengths</li> </ul>	<p><b>400440BBK</b>  <b>400440BRD</b></p>	<p><b>440A to BNC</b></p> 
<p><b>440A to 358A, (12')</b></p> <ul style="list-style-type: none"> <li>Coax Patch / Test Cord</li> <li>Available in various lengths</li> </ul>	<p><b>B40358A12</b></p>	<p><b>440A to 358A</b></p> 
<p><b>358A to 358A, (12')</b></p> <ul style="list-style-type: none"> <li>Coax Patch / Test Cord</li> <li>Available in various lengths</li> </ul>	<p><b>B00358A12</b></p>	<p><b>358A to 358A</b></p> 
<p><b>358A to BNC, (12')</b></p> <ul style="list-style-type: none"> <li>Coax Test Cord</li> <li>Available in various lengths</li> </ul>	<p><b>B00358B12</b></p>	<p><b>358A to BNC</b></p> 

FEATURES / APPLICATION	WINBUY #	DESCRIPTION
<p><b>BNC Loopback Cord, (9")</b></p> <ul style="list-style-type: none"> <li>Coax Test Cord</li> <li>Available in various lengths</li> </ul>	<p><b>400440BLP</b></p>	<p><b>BNC LOOPBACK CORD</b></p> 
<p><b>Dual BNC Coax Loopback Tool</b></p> <ul style="list-style-type: none"> <li>Used to verify Dual BNC Coax cabling</li> </ul>	<p><b>400600LPT</b></p>	<p><b>DUAL BNC COAX LOOPBACK TOOL</b></p> 
<p><b>358A Coax Loopback Tool</b></p> <ul style="list-style-type: none"> <li>Used to verify 358A Coax cabling</li> </ul>	<p><b>400358LPT</b></p>	<p><b>358A COAX LOOPBACK TOOL</b></p> 
<p><b>Dual 440D Coax Loopback Tool</b></p> <ul style="list-style-type: none"> <li>Used to verify Dual 440D Coax cabling</li> </ul>	<p><b>400440LPT</b></p>	<p><b>DUAL 440D COAX LOOPBACK TOOL (Female)</b></p> 

## COAX PATCH CORDS

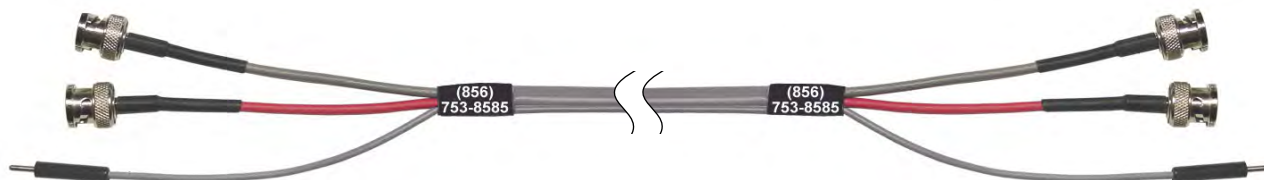

### Ordering Information:

	<b><u>WINBUY #</u></b>
Dual BNC to Dual BNC w/ tracer, (5')	400440BB05
Dual BNC to Dual BNC w/ tracer, (10')	400440BB10
Dual BNC to Dual BNC w/ tracer, (15')	400440BB15
Dual BNC to Dual BNC w/ tracer, (20')	400440BB20
Dual BNC to Dual BNC w/ tracer, (25')	400440BB25
Dual BNC to Dual BNC w/ tracer, (30')	400440BB30
Dual BNC to Dual BNC w/ tracer, (35')	400440BB35
Dual BNC to Dual BNC w/ tracer, (40')	400440BB40
Dual BNC to Dual BNC w/ tracer, (45')	400440BB45

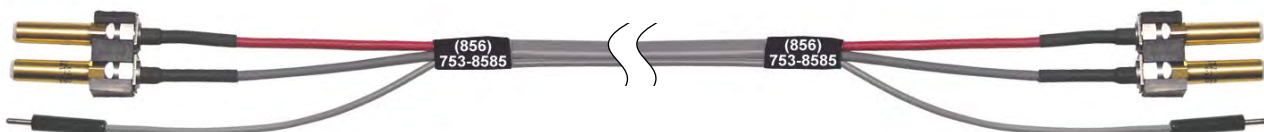

### Ordering Information:

	<b><u>WINBUY #</u></b>
Dual 440D to Dual 440D w/ tracer, (5')	400440DD05
Dual 440D to Dual 440D w/ tracer, (10')	400440DD10
Dual 440D to Dual 440D w/ tracer, (15')	400440DD15
Dual 440D to Dual 440D w/ tracer, (20')	400440DD20
Dual 440D to Dual 440D w/ tracer, (25')	400440DD25
Dual 440D to Dual 440D w/ tracer, (30')	400440DD30
Dual 440D to Dual 440D w/ tracer, (40')	400440DD40
Dual 440D to Dual 440D w/ tracer, (50')	400440DD50

150 Cooper Rd. (F-15)  
W. Berlin, NJ 08091

[www.tagcords.com](http://www.tagcords.com)

**Telecom Assistance Group**

Telephone: (856) 753-8585

Fax: (856) 768-7645

**ADSL Test Cord**

**400548ADSL**

Protector to RJ48 "Y" - 6' (ADSL)

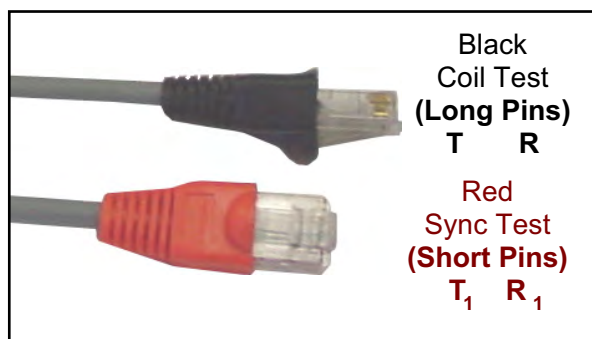
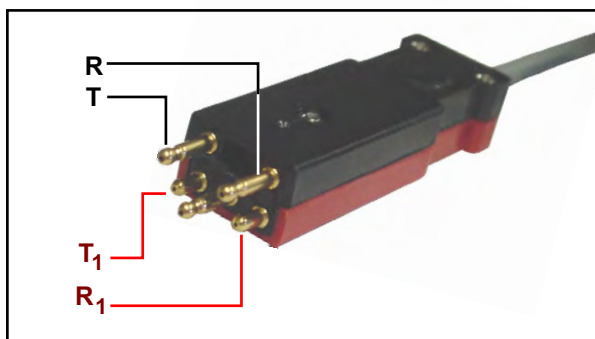

**WIRING NOTES:**

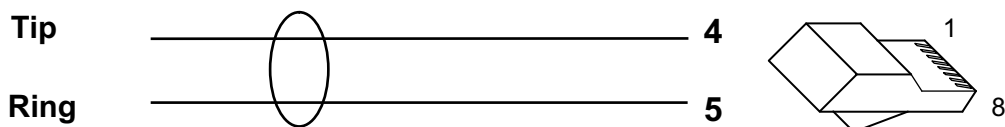

**Application:**

Used with Sunrise ADSL Test Set.  
 Plug Red RJ48 in test set to perform Sync Test.  
 Plug Black RJ48 in test set to perform Coil Test.

<p><b>Ordering Information:</b>                  ADSL Test Cord, (6')</p>	<p><b>WINBUY #</b>                  400548ADSL</p>
---	--

150 Cooper Rd. (F-15)  
 W. Berlin, NJ 08091

[www.tagcords.com](http://www.tagcords.com)

Telephone: (856) 753-8585  
 Fax : (856) 768-7645

**Telecom Assistance Group**

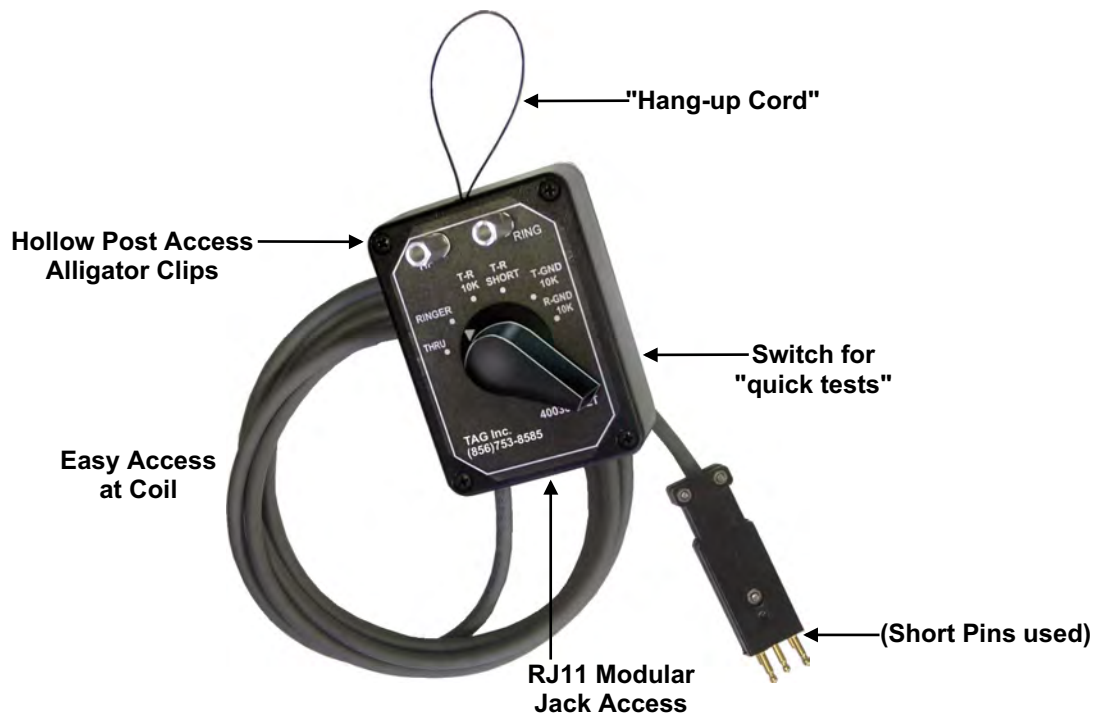
**MLT Load / Test Box****400300MLT**

TAG's MLT Load/Test Box (400300MLT) provides a convenient and easy means to **Test** with **MLT** on **New Installs** and **Calibrate "Loop Resistance"**.

Simply plug the MLT Load/Test Box on the circuit to test with MLT. Establish communication with a MLT tester to verify results.

Note: TAG offers a "Hands Free" Telephone Set - Model WT-1K for added convenience. A sturdy switch on the MLT Load/Test Box allows selecting the following tests:

- Tip to Ring Short
- Ring to Ground (10K)
- Tip to Ring Load (10K)
- Ringer Test Load (>.75A)
- Tip to Ground (10K)
- Thru to Hollow Posts and RJ11 (just in case)

The MLT Load/Test Box plugs to various interface points for ease of testing with MLT. The 400300MLT can be equipped with "coil access" at the RT, RJ11 access at the NID or Alligator Clips for general purpose.

**Ordering Information:****Cord Protector MLT Test Box, (6')****WINBUY #****400300MLT**

150 Cooper Rd. (F-15)  
W. Berlin, NJ 08091

[www.tagcords.com](http://www.tagcords.com)

Telephone: (856) 753-8585  
Fax : (856) 768-7645

**Telecom Assistance Group**

# HST-3000\* / CopperPro 990\*\* Cord Kit

# KITCP990BST

**Kit Designed for  
HST-3000 /  
CopperPro Test Set &  
Far End Device**

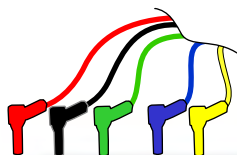
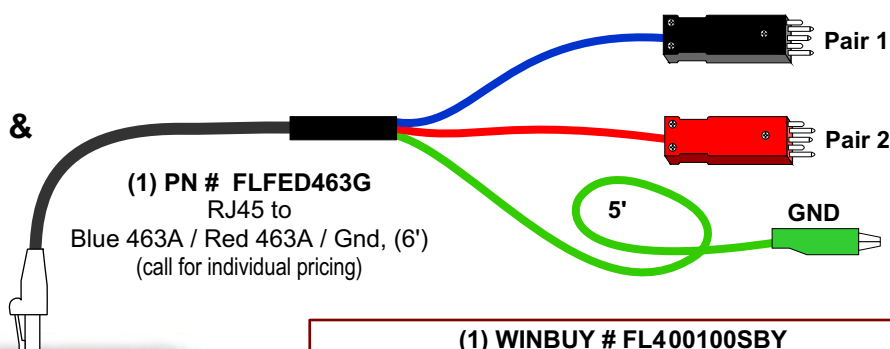

*Fluke TN2100 & CopperPro not included*



**KIT INCLUDES CARRYING CASE**

**(1) PN # TCC001**  
8 Pouch Carrying Case  
(call for individual pricing)

- (1) WINBUY # FL400100SBY**  
HST / Fluke to 463A Protector (Blue), (6')
- (1) WINBUY # FL400100SRD**  
HST / Fluke to 463A Protector (Red), (6')
- (1) WINBUY # FL400100WPBY**  
HST / Fluke to Wire Wraps (Blue), (6')
- (1) WINBUY # FL400100WPRD**  
HST / Fluke to Wire Wraps (Red), (6')
- (1) WINBUY # FL400100BY**  
HST / Fluke to Bantam (Blue), (6')
- (1) WINBUY # FL400100BR**  
HST / Fluke to Bantam (Red), (6')
- (1) WINBUY # FL400409**  
Ground Cord, (8')

**Ordering Information:**

**HST-3000 / CopperPro 990 Cord Kit**

includes: (1) FLFED463G, (1) FL400100SBY, (1) FL400100SRD, (1) FL400100WPBY, (1) FL400100WPRD, (1) FL400100BBY, (1) FL400100BRD, (1) FL400409 & (1) TCC001

**WINBUY # (KIT)**  
**KITCP990BST**

150 Cooper Rd. (F-15)  
W. Berlin, NJ 08091

[www.tagcords.com](http://www.tagcords.com)

Telephone: (856) 753-8585  
Fax : (856) 768-7645

## Telecom Assistance Group

Copyright © 2025 by Telecom Assistance Group, Inc.  
\* HST-3000 is a registered Trademark of JDSU.  
\*\* Copper Pro 990 is a registered Trademark of Fluke Corp.

# JDSU HST-3000\* Test Cords

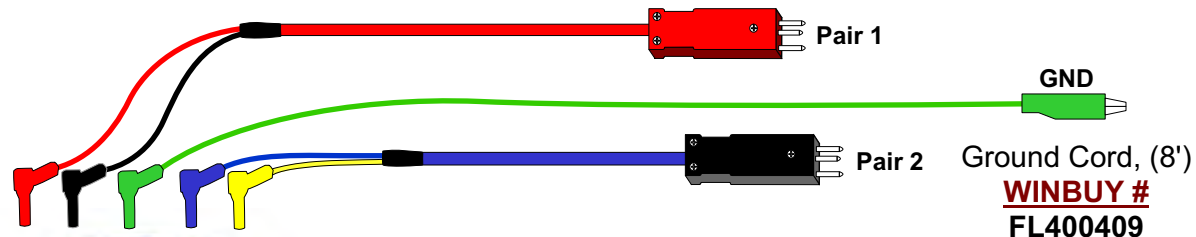

**\*\* Kits are Available -  
Please Call  
for more Information \*\***



8 Pouch Carrying Case  
**PN # TCC01**  
(call for pricing)

HST to 463A Protector (Red), (6')  
**WINBUY # FL400100SRD**



HST to 463A Protector (Blue), (6')  
**WINBUY # FL400100SBY**



HST to Wire Wraps (Red), (6')  
**WINBUY # FL400100WPRD**



HST to Wire Wraps (Blue), (6')  
**WINBUY # FL400100WPBY**



HST to Bantam (Red), (6')  
**WINBUY # FL400100BR**



HST to Bantam (Blue), (6')  
**WINBUY # FL400100BY**



150 Cooper Rd. (F-15)  
W. Berlin, NJ 08091

[www.tagcords.com](http://www.tagcords.com)

Telephone: (856) 753-8585  
Fax : (856) 768-7645

**Telecom Assistance Group**

## BST - DLC Cord Kit

## DLCKITBST



(1) # **TCC001** - 8 Pouch Carrying Case

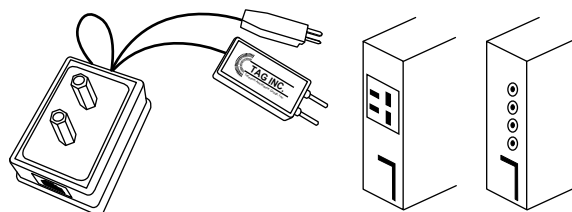

(1) # **4003956** - "The Slick Cord" - Series 5 & SLC 96



(2) # **400210A** - Bantam to (2) Alligator Clips, (6')



(1) # **40070325** - DB9 Pin (f) to DB25 Pin (m), (25')



(2) # **408210** - Bantam to 800 DSX, (6')



(1) # **400722ADSL** - Catena DB9 Pin (f) to RJ45, (6')



(2) # **400210WP** - Bantam to Wire Wraps, (6')



(1) # **400720** - DB9 Pin (m) to DB9 Pin (f), (6')

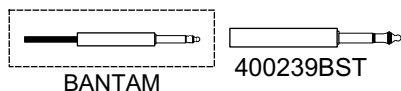

(2) # **400239BST** - Bantam to 310 Conversion Plug



(1) # **400703H25** - DB9 Pin (m) to DB25 Pin (m), (25')



(1) # **400440BLP** - BNC Loopback Cord, (9')

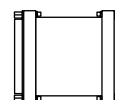

(1) # **400725N** - 25 Pin (m) to 25 Pin (f) "NULL" Adapter



(1) # **400210BK** - Bantam to Bantam, RX - Black, (6')



(1) # **400448XP10** - DMX Provisioning (CAT5E) Cable, (10')



(1) # **400210RD** - Bantam to Bantam, TX - Red, (6')



(1) # **40044806** - RJ48 to RJ48, (6')

### Ordering Information:

#### BST - DLC Cord Kit

includes: (2) 400210A, (1) 400210BK, (1) 400210RD, (2) 408210, (1) 400720, (2) 400210WP, (2) 400239BST, (1) 4003956, (1) 400725N, (1) 40070325, (1) 400448XP10, (1) 400440BLP, (1) 400703H25, (1) 400722ADSL, (1) 40044806 & (1) TCC001

**WINBUY # (KIT)**  
**DLCKITBST**

150 Cooper Rd. (F-15)  
W. Berlin, NJ 08091

[www.tagcords.com](http://www.tagcords.com)

**Telecom Assistance Group**

Telephone: (856) 753-8585  
Fax : (856) 768-7645

**"Green Coil Cord"****400300FP****"Frogger" Protector Test Cord, (20')**

1. Insert "Good" (green) plug into known good line.
2. Insert "Bad" (red) plug into bad line for temporary restoration.

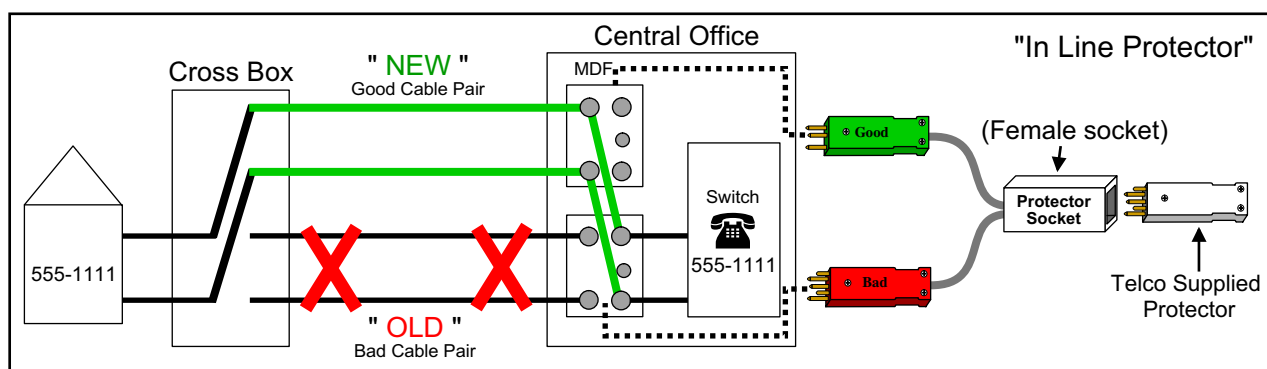
**Application:**

TAG's Temporary Restoral Cord (400300FP) allows you to add protection back to the telephone line when testing. TAG's test cord features a built-in protector socket that accepts any 5-pin protector module. A 5-pin module with the same specifications as the line you are testing on must be inserted before the test cord can function. Once inserted, the cord will now function and protection has been restored to the line.

In the event of a power or lightning strike, TAG's 400300FP can save thousands of dollars by eliminating dangers that can destroy expensive equipment or possibly harm a technician. One plug is Green "GOOD" & the other plug is Red "BAD". When the repair is made, the circuit can be identified as to which pair is good or bad.

**Ordering Information:****"Frogger" Protector Test Cord - (20')\*****WINBUY #****400300FP***\*Available in various lengths. Call for Pricing.*

150 Cooper Rd. (F-15)  
W. Berlin, NJ 08091

[www.tagcords.com](http://www.tagcords.com)

Telephone: (856) 753-8585  
Fax : (856) 768-7645

**Telecom Assistance Group**

## Colt 250\* / Exfo 635\* Test Cords

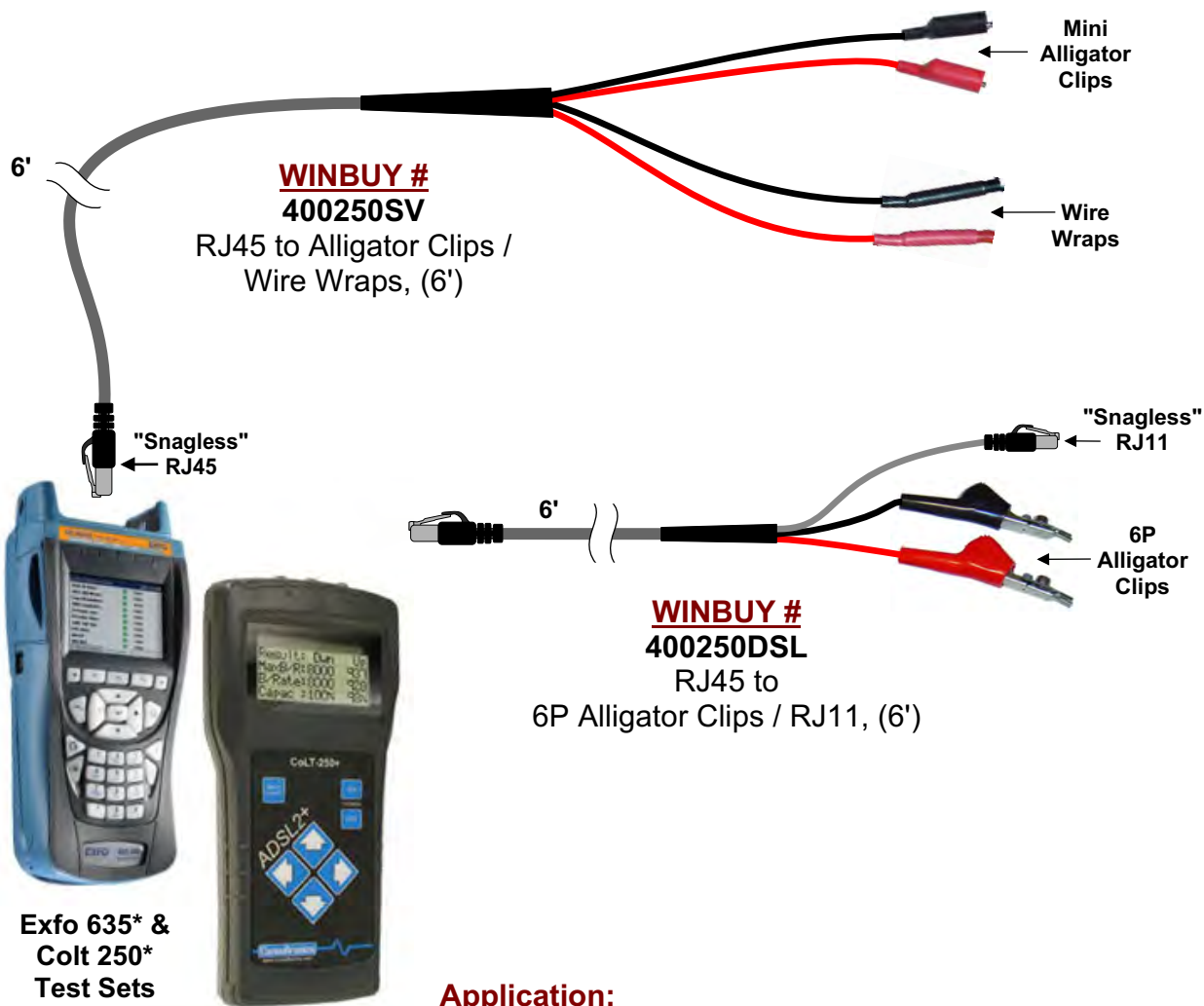

**Exfo 635\* & Colt 250\* Test Sets**  
(not included)

**Application:**

The cords shown above are used with the Colt 250\* and/or Exfo 635\* test set to perform DSL testing.

**Ordering Information:**

- RJ45 to Mini Alligator Clips / Wire Wraps, (6')
- RJ45 to 6P Alligator Clips / RJ11, (6')

- WINBUY #**  
400250SV  
400250DSL

150 Cooper Rd. (F-15)  
W. Berlin, NJ 08091

[www.tagcords.com](http://www.tagcords.com)

Telephone: (856) 753-8585  
Fax : (856) 768-7645

**Telecom Assistance Group**

# Calix C7 Streaker Kit

# C7KIT01

## "Calix C7"



### The (# C7KIT01) Kit Includes:

**(1) STCALIXC7**  
Calix C7 Streaker Card w/ LEDs

### **Application:**

The STCALIXC7 provides a quick method to "streak", verify wiring via LEDs, from the backplane of the Calix C7 to the Frame. At the Frame simply ground the corresponding pins and the STCALIXC7 will light the LED associated with that connection.



Approx. Dimensions:  
13" (H) x 20" (L)



**(1) P2000**  
Protected (-48V) Test Probe w/ LED, (6')



**(1) 400409**  
Pin Plug to Alligator, (6')



**(1) 600209F**  
Carrying Case

### **Ordering Information:**

#### **Calix C7 Streaker Kit**

includes: (1) STCALIXC7, (1) 400409, (1) P2000 & (1) 600209F

**WINBUY # (KIT)**  
**C7KIT01**

150 Cooper Rd. (F-15)  
W. Berlin, NJ 08091

[www.tagcords.com](http://www.tagcords.com)

Telephone: (856) 753-8585  
Fax : (856) 768-7645

## Telecom Assistance Group

## Apparatus Cases (T1, HDSL, DDS)

### **WINBUY # EXT209B** (w/ Bantam Jacks) T1 Loopback Extender

#### **Application:**

- Universal interface to all test sets
- Loops signal and simplex current
- Isolates trouble to repeater or cable
- Bantam Jack access eliminates special probes and cables
- Direct metallic bridging allows current, voltage and loop resistance measurements

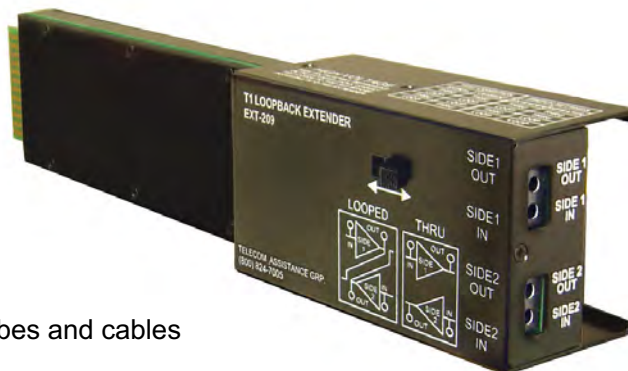

### **WINBUY # EXT209TB** (w/ Bantam Jacks) T1 Repeater Extender

#### **Application:**

- Span current test points
- Loops signal and simplex current
- Test repeaters in the field
- Bantam Jack access to monitor/transmit QRSS, 3 in 24 from test sets
- Direct metallic bridging allows current, voltage and loop resistance measurements



### **WINBUY # CT239239** T1 Line Repeater Cut Thru Card

#### **Application:**

The CT239239 plugs into T1, 56KB, HDSL, and ISDN apparatus cases. Plug the CT239239 into non-powered mini T1 line repeater slots to bypass unused pairs for line testing.

150 Cooper Rd. (F-15)  
W. Berlin, NJ 08091

[www.tagcords.com](http://www.tagcords.com)  
**Telecom Assistance Group**

Telephone: (856) 753-8585  
Fax: (856) 768-7645

# T1 Repeater Test Kit

# EXT238K3

The EXT238K3 Kit is designed for technicians who test at T1 Line Repeater Housings, such as 818 apparatus cases. (see Fig. 1) The Kit Includes:



**(1) 400210RD03**  
Bantam to Bantam - Red, (3')



**(1) 400210ARD03**  
Bantam to Alligator Clips - Red, (3')



**(1) 400210BK03**  
Bantam to Bantam - Black, (3')



**(1) 400210ABK03**  
Bantam to Alligator Clips - Black, (3')

### Ordering Information:

#### T1 Repeater Access Kit

includes: (1) EXT238, (1) 400210RD03, (1) 400210BK03,  
(1) 400210ARD03, (1) 400210ABK03 & (1) 600209

**WINBUY # (KIT)**  
**EXT238K3**

**T1 Line Repeater Wiring Access Board (w/ Bantam Jacks)**

**EXT238**

150 Cooper Rd. (F-15)  
W. Berlin, NJ 08091

[www.tagcords.com](http://www.tagcords.com)

Telephone: (856) 753-8585  
Fax : (856) 768-7645

## Telecom Assistance Group

## Apparatus Cases (T1, HDSL, DDS)

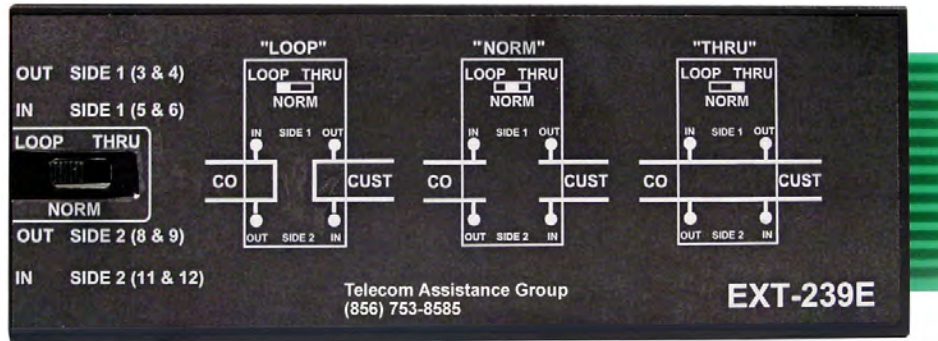

**WINBUY # EXT239E**  
 Plugs into T1, 56KB, HDSL,  
 ISDN Apparatus Cases

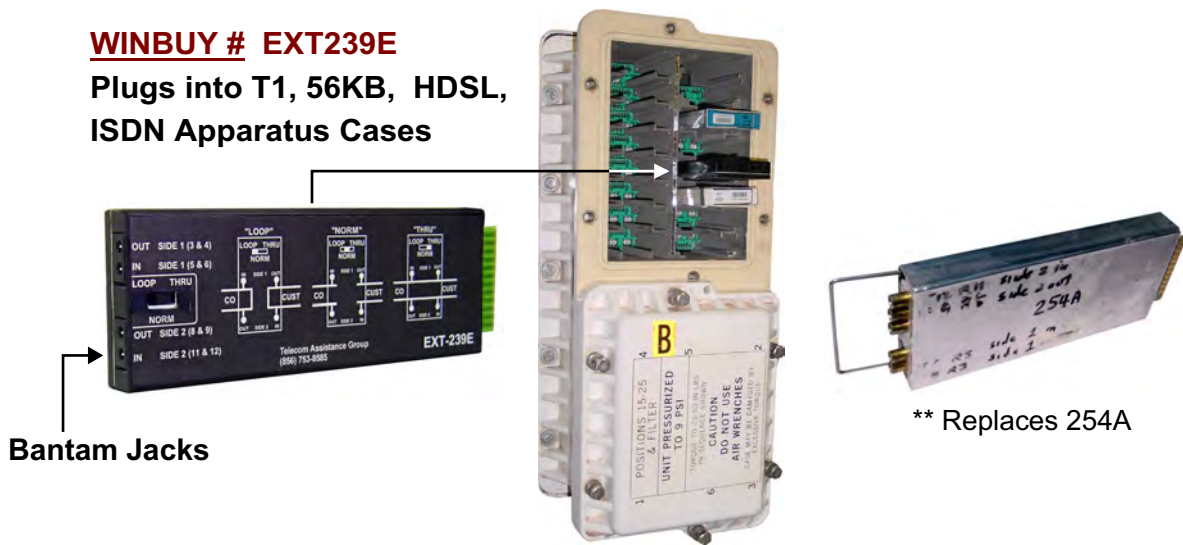

**Bantam Jacks**

**Features:**

- Enhanced switch settings for Thru, Norm, and Loop testing at T1 line repeater apparatus cases
- Metallic access at T1 line repeater slots
- Use with test sets to perform Cable Loss, Resistance, or TDR test set to locate load coils

<b>Ordering Information:</b>	<b>WINBUY #</b>
T1 Wiring Access Board	<b>EXT239E</b>
Bantam to Alligator Clips, (6')	<b>400210A</b>

*Carrying Case is available (PN # 600209) - Call for Pricing*

150 Cooper Rd. (F-15)  
 W. Berlin, NJ 08091

[www.tagcords.com](http://www.tagcords.com)

Telephone: (856) 753-8585  
 Fax : (856) 768-7645

## Telecom Assistance Group

**ORB Test Kit**

**KITTB0RBB**



**WINBUY # TB86B**  
 "DDM Plus" Office Repeater  
 Test Board w/ Bantam Jacks



**WINBUY # TB3192B**  
 3190/3192 Office Repeater  
 Test Board w/ Bantam Jacks



**# TB231B**  
 220 (Kentrox size) Office Repeater  
 Test Board w/ Bantam Jacks



**# TB400B**  
 HDSL Remote HRU-200/400  
 Mechanics w/ Bantam Jacks



**WINBUY # EXT239E**  
 T1 Line Repeater Access Board  
 w/ Bantam Jacks

**WINBUY # 400210A**  
 (1) Bantam to Alligator Clips-Red, (6')



**WINBUY # 400210A**  
 (1) Bantam to Alligator Clips-Black, (6')



**# 600209N**  
 Carrying Case

**Ordering Information:**

**ORB Test Kit**

includes: (1) TB86B, (1) TB231B, (1) TB3192B, (1) TB400B,  
 (1) EXT239E, (2) 400210A & (1) 600209N - carrying case

**WINBUY # (KIT)**  
**KITTB0RBB**

150 Cooper Rd. (F-15)  
 W. Berlin, NJ 08091

[www.tagcords.com](http://www.tagcords.com)

**Telecom Assistance Group**

Telephone: (856) 753-8585

Fax : (856) 768-7645

**ORB Test Kit**

**KITTB0RBB02**



**WINBUY # TB86B**  
 "DDM Plus" Office Repeater  
 Test Board w/ Bantam Jacks



**WINBUY # TB3192B**  
 3190/3192 Office Repeater  
 Test Board w/ Bantam Jacks



**# TB231B**  
 220 (Kentrox size) Office Repeater  
 Test Board w/ Bantam Jacks



**WINBUY # TBTA3000ORB**  
 Adtran Total Access 3000 Test Board  
 w/ Bantam Jacks



**# TB400B**  
 HDSL Remote HRU-200/400  
 Mechanics w/ Bantam Jacks



**WINBUY # EXT239E**  
 T1 Line Repeater Access Board  
 w/ Bantam Jacks

**WINBUY # 400210A**  
 (1) Bantam to Alligator Clips-Red, (6')



**WINBUY # 400210A**  
 (1) Bantam to Alligator Clips-Black, (6')



**# 600209N**  
 Carrying Case

**Ordering Information:**

**ORB Test Kit**

includes: (1) TB86B, (1) TB231B, (1) TB3192B, (1) TB400B,  
 (1) TBTA3000ORB, (1) EXT239E, (2) 400210A & (1) 600209N - carrying case

**WINBUY # (KIT)**  
**KITTB0RBB02**

150 Cooper Rd. (F-15)  
 W. Berlin, NJ 08091

[www.tagcords.com](http://www.tagcords.com)

**Telecom Assistance Group**

Telephone: (856) 753-8585  
 Fax : (856) 768-7645

# Portable "R" - HDSL Test Kit

# RHDSLBST01

**RHDSLBST01**  
Portable "R" - HDSL Test Kit

**KIT INCLUDES CARRYING CASE**



**(1) 600509**  
Carrying Case  
Approx. Dimensions:  
8" (H) x 9" (L)

**(1) TRHDSL**  
Portable "R" HDSL Test Unit



(cards not included)

- ▶ **4 Slots for 200/400 Mech. HDSL "R" Cards**
- ▶ **Rugged Connectors**
- ▶ **Various Test Cords**



**4W6P08** →

**(1) 4W6P08**  
Female Lock Plug to  
(4) 6P Alligator Clips, (8')

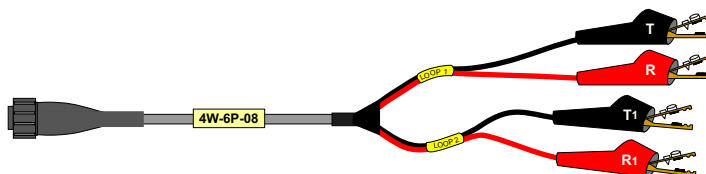

**(1) 4W463Y08**  
Female Lock Plug to  
5 Pin "Y" Protector, (8')

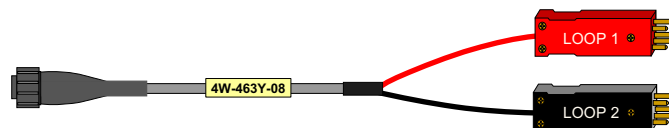

### Ordering Information:

**Portable "R" - HDSL Test Kit**  
includes: (1) T-RHDSL, (1) 4W-6P-08, (1) 4W-463Y-08 &  
(1) 600509 - carrying case

**Female Lock Plug to (4) 6P Alligator Clips, (8')**

**Female Lock Plug to 5 Pin "Y" Protector, (8')**

**WINBUY # (KIT)**  
**RHDSLBST01**

**4W6P08**

**4W463Y08**

150 Cooper Rd. (F-15)  
W. Berlin, NJ 08091

[www.tagcords.com](http://www.tagcords.com)  
**Telecom Assistance Group**

Telephone: (856) 753-8585  
Fax: (856) 768-7645

# Portable HDSL "C" Test Unit - 3192 & 220 Kit

# PHTUC02KIT01

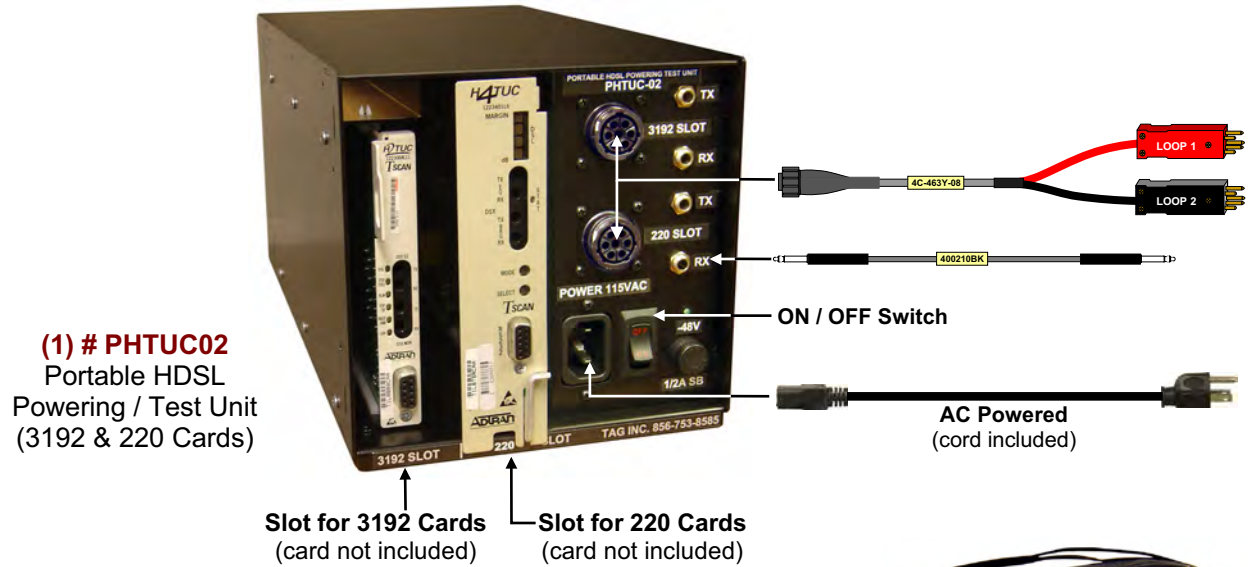

- ▶ 2 Slots (3192 & 220)
- ▶ Bantam Jacks for T1 Test Sets
- ▶ Isolates Troubles
- ▶ New Installs

**KIT INCLUDES CARRYING CASE**



**(1) # 600510**  
Carrying Case  
Approx. Dimensions:  
14" (H) x 9" (L) x 7" (D)

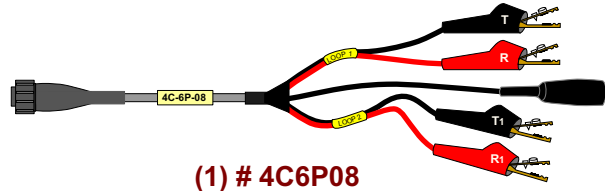

**(1) # 4C6P08**  
Male Lock Plug to (4) 6P Alligator Clips w/ GND, (8')

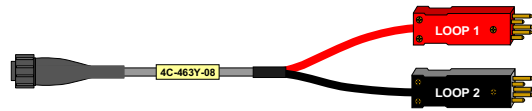

**(1) # 4C463Y08**  
Male Lock Plug to 5 Pin "Y" Protector, (8')

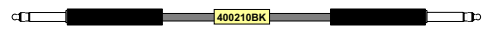

**(1) # 400210BK**  
Bantam to Bantam Test Set Cord - Black, (6')

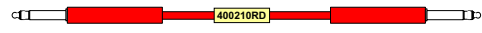

**(1) # 400210RD**  
Bantam to Bantam Test Set Cord - Red, (6')

### Ordering Information:

**Portable HDSL "C" Test Unit - 3192 & 220 Kit**  
includes: (1) PHTUC02, (1) 4C463Y08, (1) 4C6P08, (1) 400210RD,  
(1) 400210BK & (1) 600510 - carrying case

**WINBUY # (KIT)**  
**PHTUC02KIT01**

150 Cooper Rd. (F-15)  
W. Berlin, NJ 08091

[www.tagcords.com](http://www.tagcords.com)

Telephone: (856) 753-8585  
Fax : (856) 768-7645

**Telecom Assistance Group**

## New Replacement Dumb Terminals - Transport / DACS Equipment

**NEW TERMINAL WORKS ON**  
**Titan 5500, CS1, CS1L, DACS II, III, IV, Alcatel 1631 & HDSL**  
*(Titan 5500 shown below)*

### REMOVE & REPLACE OLD / BROKEN CRTs

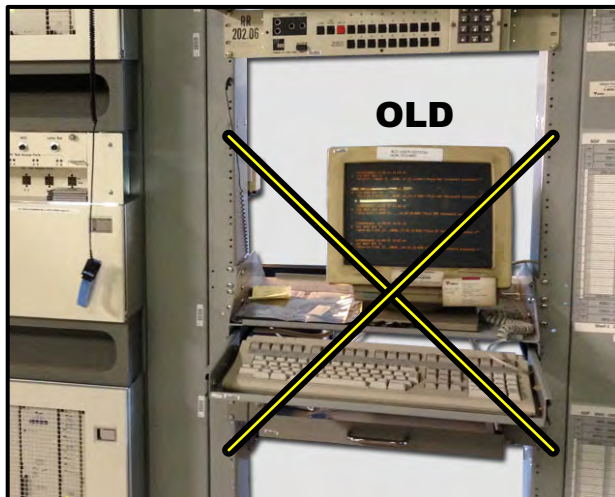

#### SPECIFICATIONS

- VT-100 COMPATIBLE
- PRINTER OUTPUT
- RS-232 INPUT(S)
- LOW POWER

#### **Ordering Information:**

##### **Single Session Dumb Terminal - Transport**

includes: (1) 17" Flat Screen Monitor, (1) Keyboard,  
 (1) Single Session Terminal Controller,  
 (1) DB25M Gender Changer & (1) Quick Guide

#### WINBUY #

**TTVT100S**

##### **Single Session Dumb Terminal - 1631 DACS**

includes: (1) 17" Flat Screen Monitor, (1) Keyboard w/ 1631 labels,  
 (1) Pre-configured 1631 Single Session Terminal Controller,  
 (1) DB25M Gender Changer & (1) 1631 Quick Guide

**TTSCA1631**

##### **Dual Session Dumb Terminal - Titan 5500**

includes: (1) 17" Flat Screen Monitor, (1) Keyboard,  
 (1) Pre-configured Titan 5500 Dual Session Terminal Controller,  
 (2) DB25F Gender Changers & (1) Titan 5500 Quick Guide

**TTDCT55**

150 Cooper Rd. (F-15)  
 W. Berlin, NJ 08091

[www.tagcords.com](http://www.tagcords.com)

Telephone: (856) 753-8585

Fax : (856) 768-7645

**Telecom Assistance Group**

## DMS Terminal Replacements - Dual Session

### Model:

**TTDCAPDMSKIT2**

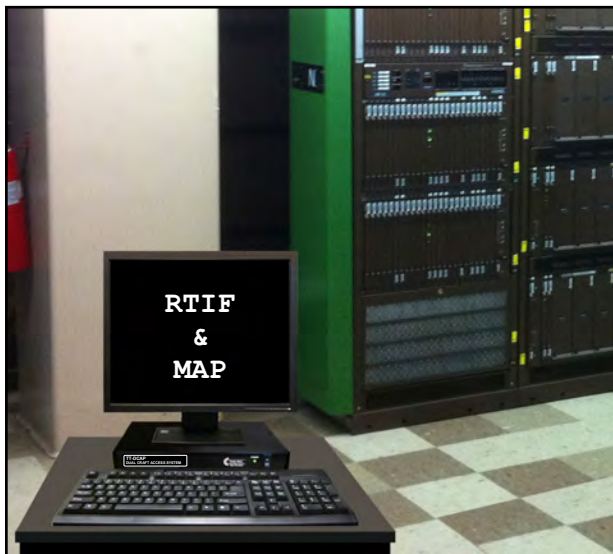

### Kit Includes (TTDCAPDMSKIT2):

- (1) 17" Flat Screen Monitor
- (1) Dumb Terminal Controller
- (1) Keyboard
- (1) Quick Guide
- (2) 400725SBW,  
(Hardwire Adapter for 400725SB2)
- (2) 400700,  
(DB25F Gender Changer) 
- (2) 400725SB2,  
(DMS Quick Connect Current Loop Adapter Cable w/ DEC Connector)



### SPECIFICATIONS

- VT-100 COMPATIBLE
- DUAL RS-232 INPUTS
- PRINTER OUTPUT
- LOW POWER

### Printer Port Type:



Parallel \* *\* If a Serial Port is needed, please order a Parallel to Serial Adapter # TTPSA, call for pricing.*

### Ordering Information:

#### **Dual Craft Access System - DMS (Kit 2)**

includes: (1) 17" Flat Screen Monitor, (1) Keyboard,  
(1) Dual Session Dumb Terminal Controller, (1) Quick Guide,  
(2) # 400700 (DB25F Gender Changer),  
(2) # 400725SB2 (DMS Quick Connect Current Loop Adapter Cable w/ DEC Connector) &  
(2) # 400725SBW (Hardwire Adapter for 400725SB2)

**WINBUY #**  
**TTDCAPDMSKIT2**

#### **Dual Craft Access System - DMS**

includes: (1) 17" Flat Screen Monitor, (1) Keyboard,  
(1) Dual Session Dumb Terminal Controller, (1) Quick Guide &  
(2) # 400700 (DB25F Gender Changer)

**TTDCAP**

**Replacement Power Pack for DMS Terminal, 5VDC** *(not shown)*

**TTDCA5PP**  
*(call for pricing)*

150 Cooper Rd. (F-15)  
W. Berlin, NJ 08091

[www.tagcords.com](http://www.tagcords.com)

Telephone: (856) 753-8585  
Fax : (856) 768-7645

**Telecom Assistance Group**

# DMS Replacement Terminals - Single Session

**Model:**

**TTSCAPDMSKIT**



**Kit Includes:**

- (1) 17" Flat Screen Monitor
- (1) Dumb Terminal Controller
- (1) Keyboard
- (1) Quick Guide
- (1) 400700,  
(DB25F Gender Changer) 
- (1) 400725SB2,  
(DMS Quick Connect Current Loop Adapter Cable w/ DEC Connector)



**SPECIFICATIONS**

- VT-100 COMPATIBLE
- SINGLE RS-232 INPUT
- PRINTER OUTPUT
- LOW POWER

**Printer Port Type:**



**Parallel \***

\* If a Serial Port is needed, please order a Parallel to Serial Adapter (# TTPSA). Please call 856-753-8585 for more information.

**Ordering Information:**

**DMS Single Session Replacement Terminal Kit**

includes: (1) 17" Flat Screen Monitor, (1) Keyboard,  
(1) Single Session Dumb Terminal Controller, (1) Quick Guide,  
(1) # 400700 (DB25F Gender Changer) &  
(1) # 400725SB2 (DMS Quick Connect Current Loop Adapter Cable w/ DEC Connector)

**WINBUY #**  
**TTSCAPDMSKIT**

**DMS Single Session Replacement Terminal Kit 2**

includes: (1) 17" Flat Screen Monitor, (1) Keyboard,  
(1) Single Session Dumb Terminal Controller, (1) Quick Guide,  
(1) # 400700 (DB25F Gender Changer) &  
(1) # 400725SB2 (DMS Quick Connect Current Loop Adapter Cable w/ DEC Connector)  
(1) # 400725SBW\*\* (Hardwire Adapter for 400725SB2) \*\*not shown

**TTSCAPDMSKIT2**

**Replacement Power Pack for DMS Terminal, 5VDC (not shown)**

**TTDCA5PP**  
(call for pricing)

150 Cooper Rd. (F-15)  
W. Berlin, NJ 08091

[www.tagcords.com](http://www.tagcords.com)

Telephone: (856) 753-8585  
Fax : (856) 768-7645

**Telecom Assistance Group**

# Siemens EWSD OMT\* Terminal Replacements



**Model:**

**TTDCAM0T**

(1) 17" Flat Screen Monitor

(1) EWSD® OMT® Controller

(1) Keyboard

(1) TTMOUSEPS  
(Optical Mouse)

(1) 400700  
(DB25F Gender Changer)

**Back of Terminal Controller:**



**Ordering Information:**

**Siemens EWSD OMT Craft Access System**  
includes: (1) 17" Flat Screen Monitor,  
(1) Keyboard, (1) EWSD OMT Controller,  
(1) # TTMOUSEPS & (1) # 400700

**WINBUY #**  
**TTDCAM0T**

**Replacement Power Pack for EWSD Terminal, 5VDC**

**TTDCA5PP**  
(call for pricing)

150 Cooper Rd. (F-15)  
W. Berlin, NJ 08091

[www.tagcords.com](http://www.tagcords.com)

Telephone: (856) 753-8585  
Fax : (856) 768-7645

**Telecom Assistance Group**

## GTD5 Terminal Replacements - Dual Session

### Model:

**TTDCAG5**

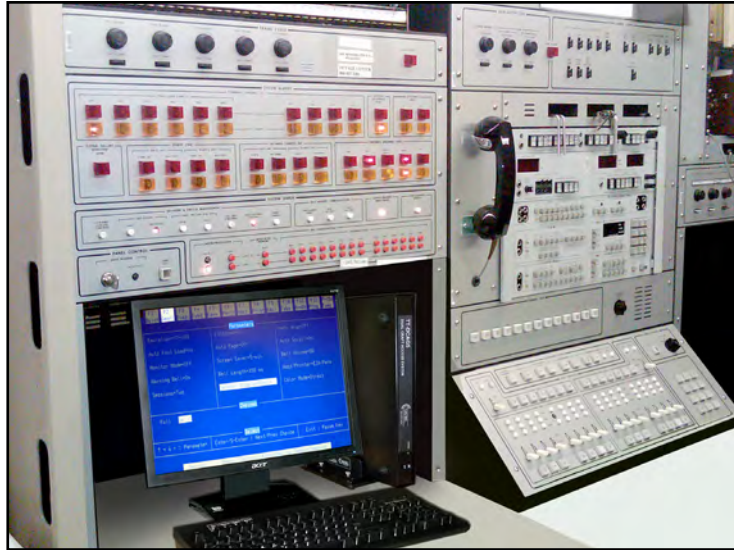

### Includes:

- (1) 17" Flat Screen Monitor
- (1) Dumb Terminal Controller
- (1) TTMTG5  
(Vertical Mounting Kit)
- (1) Keyboard
- (1) Quick Guide
- (2) 400701,  
(DB25M Gender Changer)



### SPECIFICATIONS

- VT-100 COMPATIBLE
- DUAL RS-232 INPUTS
- PRINTER OUTPUT
- LOW POWER

### Printer Port Type:



↑  
Parallel \*

\* If a Serial Port is needed, use the Parallel to Serial Adapter (PN # TTPSA) that is included in the kit.

### Ordering Information:

#### **Dual Craft Access System - GTD5 Kit**

includes: (1) 17" Flat Screen Monitor, (1) Keyboard,  
(1) Dual Session Dumb Terminal Controller, (1) Quick Guide,  
(1) # TTMTG5 (Vertical Mounting Kit),  
(2) # 400701 (DB25M Gender Changer) &  
(1) # TTPSA\*\* (Parallel to Serial Printer Adapter w/ AC Power Pack) \*\*not shown

**WINBUY #**  
**TTDCAG5KIT1**

**Replacement Power Pack for GTD5 Terminal, 5VDC** (not shown)

**TTDCA5PP**  
(call for pricing)

150 Cooper Rd. (F-15)  
W. Berlin, NJ 08091

[www.tagcords.com](http://www.tagcords.com)

Telephone: (856) 753-8585  
Fax : (856) 768-7645

**Telecom Assistance Group**

## 5ESS Terminal Replacements - Dual Session

**Model:**

**TTDCAPCE**



**Includes:**

- (1) 17" Flat Screen Monitor
- (1) Dumb Terminal Controller
- (1) Keyboard
- (1) Quick Guide
- (2) 400701,  
(DB25M Gender Changer)



**SPECIFICATIONS**

- VT-100 COMPATIBLE
- DUAL RS-232 INPUTS
- PRINTER OUTPUT
- LOW POWER

**Printer Port Type:**



Parallel \* *\* If a Serial Port is needed, please order a Parallel to Serial Adapter (PN # TTPSA). Call 856-753-8585 for more information.*

**Ordering Information:**

**Dual Craft Access System - 5ESS**

includes: (1) 17" Flat Screen Monitor, (1) Keyboard,  
(1) Dual Session Dumb Terminal Controller, (1) Quick Guide &  
(2) # 400701 (DB25M Gender Changer)

**WINBUY #**  
**TTDCAPCE**

**Replacement Power Pack for 5ESS Terminal, 5VDC (not shown)**

**TTDCA5PP**  
(call for pricing)

150 Cooper Rd. (F-15)  
W. Berlin, NJ 08091

[www.tagcords.com](http://www.tagcords.com)

Telephone: (856) 753-8585  
Fax : (856) 768-7645

**Telecom Assistance Group**

## 5ESS Terminal Replacements - Single Session

**Model:**

**TTSCAPCE**



**Includes:**

- (1) 17" Flat Screen Monitor
- (1) Dumb Terminal Controller
- (1) Keyboard
- (1) Quick Guide
- (1) 400701,  
(DB25M Gender Changer)



**SPECIFICATIONS**

- VT-100 COMPATIBLE
- SINGLE RS-232 INPUT
- PRINTER OUTPUT
- LOW POWER

**Printer Port Type:**



Parallel \* \* If a Serial Port is needed, please order a Parallel to Serial Adapter (PN # TTPSA). Call 856-753-8585 for more information.

**Ordering Information:**

**Single Craft Access System - 5ESS**

includes: (1) 17" Flat Screen Monitor, (1) Keyboard,  
(1) Single Session Dumb Terminal Controller, (1) Quick Guide &  
(1) # 400701 (DB25M Gender Changer)

**WINBUY #**

**TTSCAPCE**

**Replacement Power Pack for 5ESS Terminal, 5VDC (not shown)**

**TTDCA5PP**  
(call for pricing)

150 Cooper Rd. (F-15)  
W. Berlin, NJ 08091

[www.tagcords.com](http://www.tagcords.com)

Telephone: (856) 753-8585  
Fax : (856) 768-7645

**Telecom Assistance Group**

## DMS-100 Replacement Fans

### "DMS-100"

**WINBUY # TFDMS01**  
 48 Volt Replacement Fan for  
**DMS-100 NT3X90AC / NTB63AA**  
**Fan Trays**

w/ Power Prongs &  
 (4) Threaded\* Mounting Holes  
 (screws included)



*\* also available unthreaded - see ordering information below*

**DO YOU HAVE BROKEN DMS SENSOR PADDLES THAT NEED TO BE REPLACED?**  
**TAG HAS NEW OPTIONS** (where you won't need paddles anymore)  
 call 856-753-8585 or email [www.custsvcs@tagcords.com](mailto:www.custsvcs@tagcords.com)



### EXISTING NT3X90AC FAN TRAY w/ NEW FANS



#### **Ordering Information:**

**48V Fan for DMS-100 NT3X90AC / NTB63AA**  
**Fan Trays w/ Power Prongs &**  
**(4) Threaded Mounting Holes** (*screws included*)

#### **WINBUY #**

**TFDMS01**

**48V Fan for DMS-1U NT3X90AC / NTB63AA**  
**Fan Trays w/ Power Prongs &**  
**(4) Clear, Unthreaded Mounting Holes** (*not shown*)

**TFDMS02**  
 (call for pricing)

150 Cooper Rd. (F-15)  
 W. Berlin, NJ 08091

[www.tagcords.com](http://www.tagcords.com)

Telephone: (856) 753-8585  
 Fax : (856) 768-7645

## Telecom Assistance Group

# DMS-100 Replacement Fans



**WINBUY # TFDMSNTRX91**  
**DMS-100, 48 Volt Replacement Fan**  
w/ 3 Wire Plug

*(use in DMS-100 NTRX91AA / NT0X91AA fan units (MVIE and CSDM bays), CLEI: ENMYACM)*



**DMS-100 (NTRX91AA) FAN TRAY**

**WINBUY # TFDMS03**  
**DMS-100, 48 Volt Replacement Fan**  
w/ TTL Tach & 3 Wire Plug

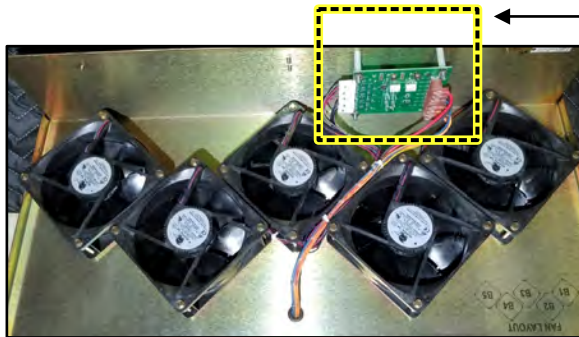

**NEW** Alarm Control Boards  
are also available,  
order # **TFC-3X90AF-01**  
(call for pricing)

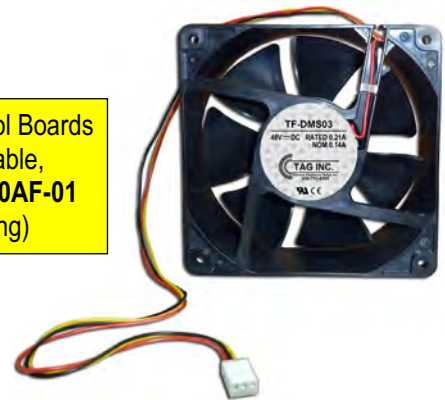

**DMS-100 (NT3X90AF) FAN TRAY**



**WINBUY # TF-DMS04AC**  
**DMS-100, 24VAC Replacement Fan**  
w/ Power Prongs

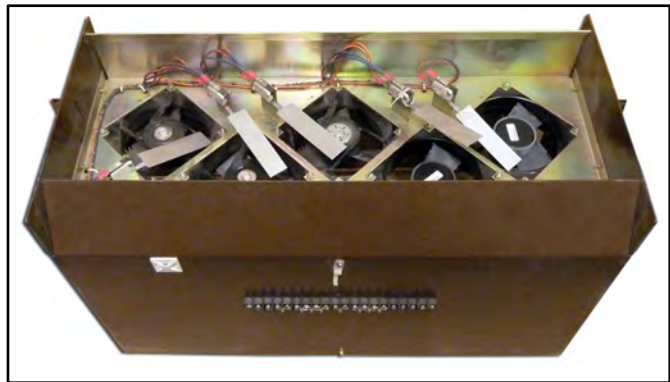

**DMS-100 (NT3X90AA/AB) (AC) FAN TRAY**

150 Cooper Rd. (F-15)  
W. Berlin, NJ 08091

[www.tagcords.com](http://www.tagcords.com)

Telephone: (856) 753-8585  
Fax : (856) 768-7645

**Telecom Assistance Group**

## Replacement Fans & Blowers (DMS-10 / DMS-100)

### "DMS-10"

Power Prongs



**WINBUY # TFDMS1001**  
**DMS-10, 48 Volt Replacement Fan**  
 w/ Power Prongs  
*(fan only, use with existing mounting)*



**FAN SHOWN w/ EXISTING DMS-10 MOUNTING BRACKET \***  
*\* (mounting bracket is not included)*

### **WINBUY # TFDMSLGN5**

**DMS-100 DPCC**  
**SuperNode Blower "Squirrel Cage"**  
 Replacement w/ Internal Sensor



### "DMS-100"



*(use in NT9X01XX DPCC, replaces A0345301)*

**NT9X01XX DPCC HAS (4) BLOWER UNITS PER BAY**

150 Cooper Rd. (F-15)  
 W. Berlin, NJ 08091

[www.tagcords.com](http://www.tagcords.com)

Telephone: (856) 753-8585  
 Fax : (856) 768-7645

**Telecom Assistance Group**

## Replacement Fans (Edgeline 100 / Cisco ONS 15454)

### "ADTRAN TA5000"

**WINBUY # TFTA5K01**  
 48 Volt Replacement Fan for  
**Adtran TA5000**  
 w/ 4 Wire Plug



40mm



### "EDGELINK 100"

**WINBUY # TFEL100KIT2**  
**Edgeline 100,**  
 Replacement Fan Kit (40mm)

**Kit includes:**

- (1) TF-EL100, Edgeline 100 Replacement Fan (40mm) &
- (1) TF-EL100DET, Edgeline 100 Replacement Detector PC Board

- 35mm Edgeline 100 fans are also available, order WINBUY # TFEL10002



### "ONS 15454"

**WINBUY # TFC1545401**  
**Cisco ONS 15454,**  
 48 Volt Replacement Fan  
 w/ 3 Wire Right Angle Connector



**CISCO ONS 15454 FAN UNIT (6 FANS)**  
*(fan tray unit is not included)*



*(use in Fan Tray # 800-21448-02,  
 HECI: WMMYAFEGAA)*

150 Cooper Rd. (F-15)  
 W. Berlin, NJ 08091

[www.tagcords.com](http://www.tagcords.com)

Telephone: (856) 753-8585  
 Fax : (856) 768-7645

**Telecom Assistance Group**

## 5ESS Replacement Fans



- ▶ All TAG Fans are NEW (No Refurbs)
- ▶ Exact Drop-in Replacements
- ▶ 48V  $\overline{\text{DC}}$  0.40A

**DON'T SEE THE FAN YOU NEED?**

**Send us a Sample  
& we will Find a Match!**

### KS22501L3 Models:

**WINBUY # TF5ESS01F**  
5ESS Replacement Fan  
w/ 3 Leads & Faston Connectors  
(fan w/ power prongs)



**PN # TF5ESS01P**  
5ESS Replacement Fan  
w/ 3 Leads & AMP Connector  
(fan w/ power prongs)



(call for pricing)

DC Fan Power Cords are available for KS22501L3 type fans  
(order TAG MODEL # TFDCPWR01)

### KS23912L2 Model:

**PN # TF5ESS03P**  
5ESS Replacement Fan  
w/ 4 Leads & AMP Connector



(call for pricing)

### KS22501L3A Models:

**WINBUY # TF5ESS04F**  
5ESS Replacement Fan  
w/ 5 Leads & Faston Connectors



**WINBUY # TF5ESS04P**  
5ESS Replacement Fan  
w/ 5 Leads & AMP Connector



### KS23912L1A Models:

**PN # TF5ESS02F**  
5ESS Replacement Fan  
w/ 5 Leads & Faston Connectors  
w/ Internal Thermal Speed Control Sensor



(call for pricing)

**PN # TF5ESS02P**  
5ESS Replacement Fan  
w/ 5 Leads & AMP Connector  
w/ Internal Thermal Speed Control Sensor



(call for pricing)

### KS23398L2 Model:

Square 5ESS Fans  
are also available

**PN # TF5ESS10P**  
ISLU (Square Fan)  
48V  $\overline{\text{DC}}$  0.13A  
w/ 5 Leads &  
AMP Connector



(call for pricing)

150 Cooper Rd. (F-15)  
W. Berlin, NJ 08091

[www.tagcords.com](http://www.tagcords.com)

Telephone: (856) 753-8585  
Fax : (856) 768-7645

**Telecom Assistance Group**

# OSP Cabinet Heat Exchanger Fans

## "Noren Cooling Unit"



**WINBUY # TFNP040201**  
48 Volt Replacement Heat Exchanger for  
Noren Cooling Unit - Internal (6.71K)  
w/ 3 Wire Open End & 3 Butt Splices

*Internal fan (circulates the air inside the cabinet, located on lower half)*

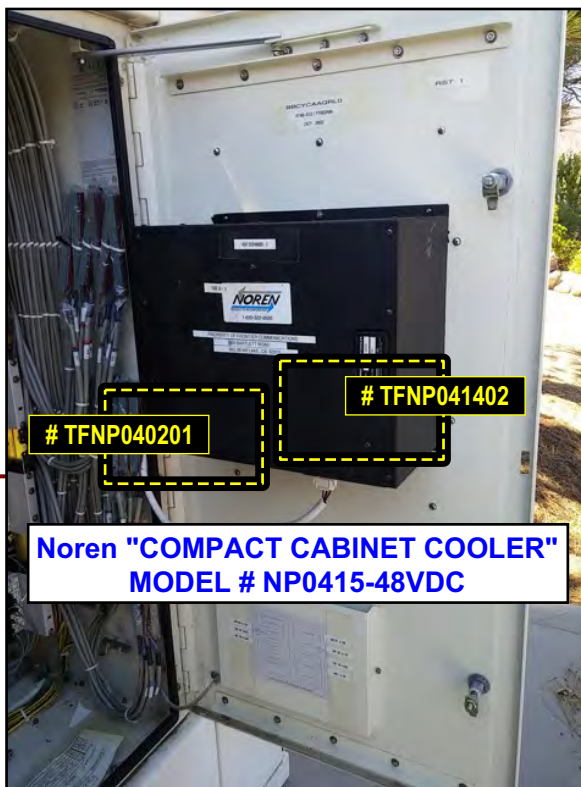

**WINBUY # TFNP041402**  
48 Volt Replacement Heat Exchanger for  
Noren Cooling Unit - External (8.45K)  
w/ 3 Wire Open End & 3 Butt Splices

*External fan (circulates the air outside the cabinet, located on top half)*

150 Cooper Rd. (F-15)  
W. Berlin, NJ 08091

[www.tagcords.com](http://www.tagcords.com)

Telephone: (856) 753-8585  
Fax : (856) 768-7645

### Telecom Assistance Group

## OSP Cabinet Replacement Fans

### "SLC96 (36 Type) Cabinet"

**WINBUY # TFTSLC96AC01**

110VAC Replacement Fan  
w/ Bracket Assembly for  
**SLC96 (36 Type) Cabinet**

*(Equiv. to Fan Assembly KS22099L5)*

**(1) 110VAC Replacement Fan \***

*\* fans can also be ordered  
separately (without mounting),  
see ordering information below*

**&**

**(1) Mounting Bracket**



**FAN ASSEMBLY  
IS FOUND INSIDE  
36 TYPE CABINETS**



**Ordering Information:**

**110VAC Fan w/ Bracket Assembly for  
SLC96 (36 Type) Cabinet** *(Equiv. to Fan Assembly KS22099L5)*

**WINBUY #  
TFTSLC96AC01**

**Also Available:** *(call for pricing)*

**110VAC (Low Temp) Fan w/ Bracket Assembly for  
SLC96 (36 Type) Cabinet** *(Equiv. to Fan Assembly KS22099L5)*

**TFTSLC96AC01L**

**110VAC Fan (fan only) for SLC96 (36 Type) Cabinet**  
*(includes power wire, (3) butt splices & hardware) (use in Fan Assembly KS22099L5)*

**TFSLC96AC02**  
(fan only)

150 Cooper Rd. (F-15)  
W. Berlin, NJ 08091

[www.tagcords.com](http://www.tagcords.com)

Telephone: (856) 753-8585  
Fax : (856) 768-7645

**Telecom Assistance Group**

## OSP Cabinet Heat Exchanger Fans

### "LS2000 / 2030 - Tarzan"

**WINBUY # TFACABT201A**  
 48V Heat Exchanger (Tarzan) for  
 Litespan 2000 (LSC-2030)  
 Cabinet Heat Stack

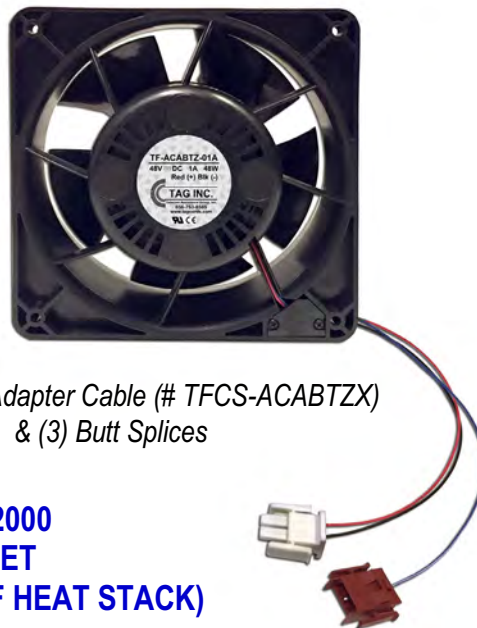

Includes: (1) Adapter Cable (# TFCS-ACABTZX)  
 & (3) Butt Splices

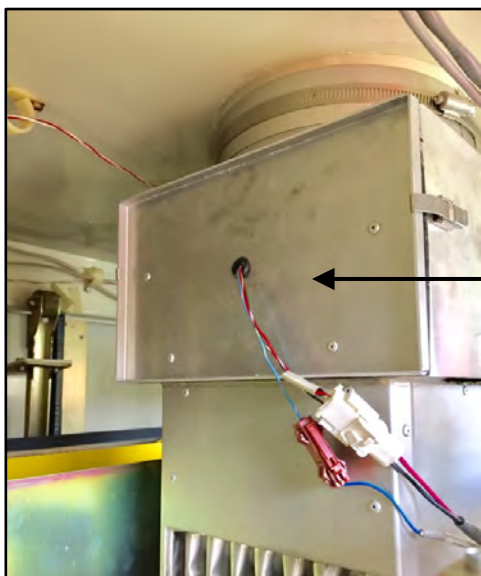

**DSC LITESPAN 2000  
 LSC-2030 CABINET  
 (INSIDE VIEW OF HEAT STACK)**

w/ (1) - 2 Wire Amp Connector  
 (Power, red / black wires)  
 &  
 (1) - 1 Wire Amp Connector  
 (Alarm, blue wire)

### "Mesa 768 Cabinet"

(133mm)



*(fan only - use with existing  
 mounting bracket)*

**WINBUY # TFMC13302**  
 (133mm) Heat Exchanger for  
 Mesa 768 Cabinets  
 w/ 3 Pin Plug

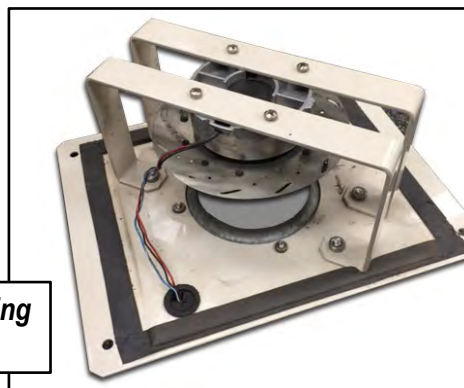

150 Cooper Rd. (F-15)  
 W. Berlin, NJ 08091

[www.tagcords.com](http://www.tagcords.com)

Telephone: (856) 753-8585  
 Fax : (856) 768-7645

**Telecom Assistance Group**

# OSP Cabinet Heat Exchanger Fans

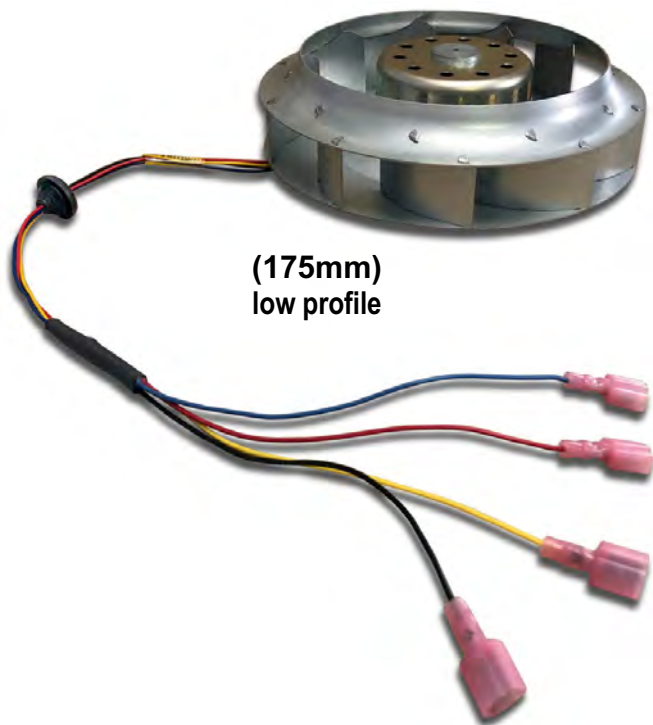

(175mm)  
low profile

## "ODC Cabinet Door HX"

**WINBUY # TFHX175LP01**  
(175mm) "Low Profile"  
Heat Exchanger for **Asymblix,**  
**Calix ODC Cabinet Door**

*w/ Grommet, 4 Leads  
& Faston Connectors*

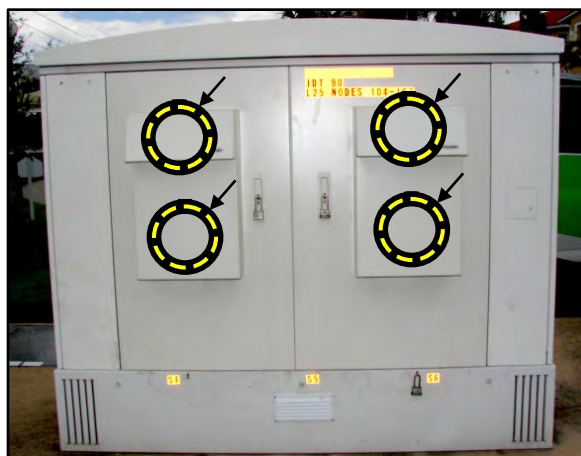

**CALIX ODC CABINET (DOOR)**

**(2) HEAT EXCHANGERS MOUNTED IN EACH DOOR  
(4) FANS TOTAL**

## "ODC 1000 Cabinet HX"

**WINBUY # TFHX220LP01**  
(220mm) "Low Profile"  
Heat Exchanger for  
**Calix ODC 1000 Cabinet**

*w/ 4 Leads & Faston Connectors*

*(fan only,  
use with existing mounting bracket)*

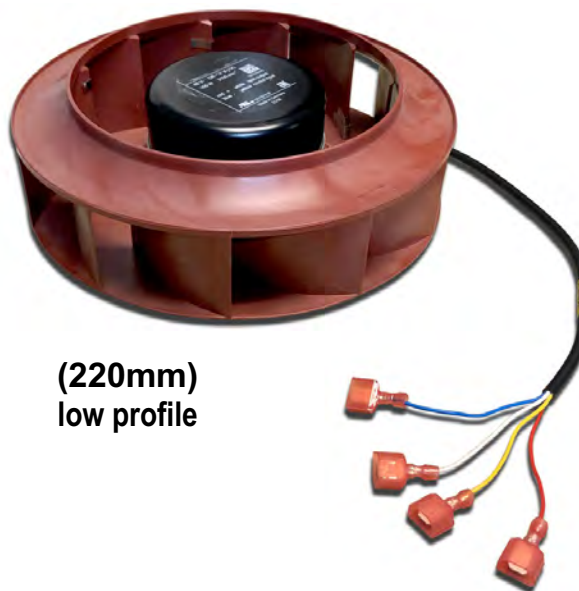

(220mm)  
low profile

150 Cooper Rd. (F-15)  
W. Berlin, NJ 08091

[www.tagcords.com](http://www.tagcords.com)

Telephone: (856) 753-8585  
Fax : (856) 768-7645

# Telecom Assistance Group

## OSP Cabinet Heat Exchanger Fans

- ▶ **Commonly used in Mesa type Cabinets**
- ▶ **Common Replacements for :**
  - EBM R1G225-AC73-XX (where XX=36,38,39,52)
  - EBM R1G225-AF11-XX (where XX=13,14)
  - EBM R1G225-AE07-11
  - EBM R1F250-AQ00-XK
  - EBM R1G225-AG39-10
  - EBM R1G225-AG15-AA
- ▶ **All TAG Fans are NEW (No Refurbs)**

**TOP OF MESA CABINET**  
w/ EXISTING FAN  
(ORDER WINBUY # TFMC22501)



**BOTTOM OF MESA CABINET**  
w/ EXISTING FAN  
(ORDER WINBUY # TFMC22502)

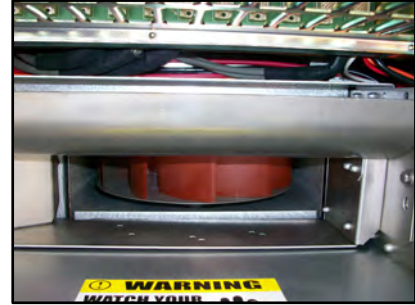

**WINBUY # TFMC22501 \***  
**(225mm) Heat Exchanger for**  
**Mesa Cabinet (Top)**

w/ Round Weatherproof Connector

*\* use with existing bracket*

*(Fans are accessed through a panel on the solar shield)*



**WINBUY # TFMC22502 \*\***  
**(225mm) Heat Exchanger for**  
**Mesa Cabinet (Bottom)**

w/ 4 Wire Plug

**\*\* fan only, use with existing bracket -**

*(order # TF-MC225-02-KIT for w/ fan & bracket)*



150 Cooper Rd. (F-15)  
W. Berlin, NJ 08091

[www.tagcords.com](http://www.tagcords.com)

Telephone: (856) 753-8585  
Fax : (856) 768-7645

**Telecom Assistance Group**

# OSP Cabinet Heat Exchangers & Environmental Control Unit (ECU)

## "Mesa DSLAM 384 Cabinet"



**WINBUY # TFMESA38401**  
 48V (External) Heat Exchanger for  
 Mesa DSLAM 384 Cabinet  
 w/ 4 Wire Round  
 Female Weatherproof Plug

*(Internal Fans are also available,  
 order WINBUY # TFMESA38402  
 (see ordering information below))*

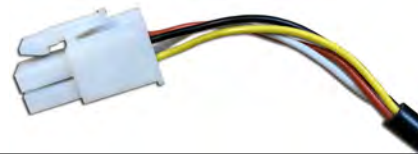

(OUTSIDE - HEAT EXCHANGERS)

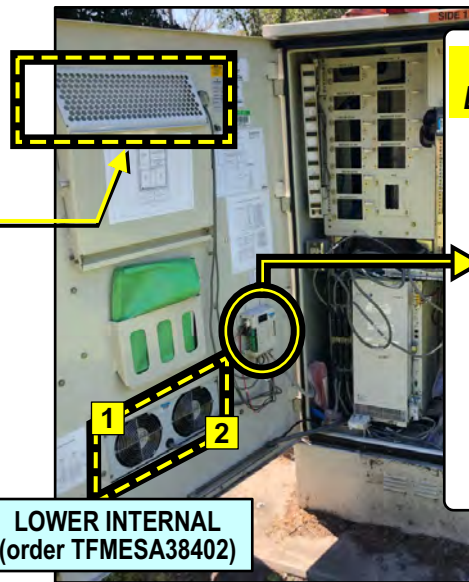
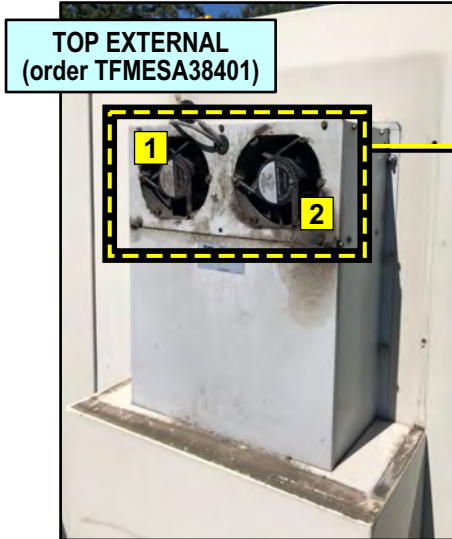

**LOWER INTERNAL**  
 (order TFMESA38402)

(INSIDE - HEAT EXCHANGERS & ECU)

**Need a Replacement  
 ECU for this Cabinet ?**

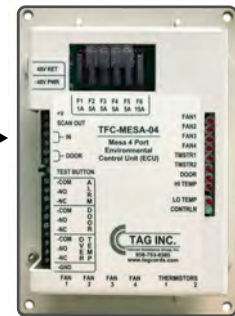

**PN # TFCMESA04**

### Ordering Information:

48V Heat Exchanger for Mesa DSLAM 384 Cabinet w/ 4 Wire (Round)  
 Female Weatherproof Plug (*Top External Fans*)

**WINBUY #**  
**TFMESA38401**

48V Heat Exchanger for Mesa DSLAM 384 Cabinet w/ 4 Wire (Square)  
 Female Plug, (8' cable) (*Lower Internal Fans*)

**TFMESA38402**

4 Port Environmental Control Unit (ECU) Replacement  
 (used in Mesa 2 - DSLAM 192 & DSLAM 384 Type Cabinets)

**TFCMESA04**  
 (call for pricing)

150 Cooper Rd. (F-15)  
 W. Berlin, NJ 08091

[www.tagcords.com](http://www.tagcords.com)

Telephone: (856) 753-8585  
 Fax : (856) 768-7645

**Telecom Assistance Group**

## OSP Cabinet Heat Exchanger Fans

### "Marconi Mesa (Bottom)"

**WINBUY # TFMESA601**  
 48V Replacement Heat Exchanger for  
 Marconi Mesa "Bottom" HX Cabinet  
*w/ 3 Wire Plug*

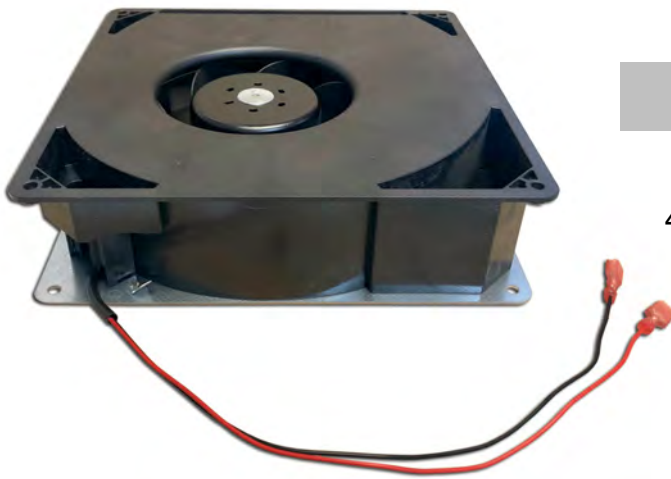
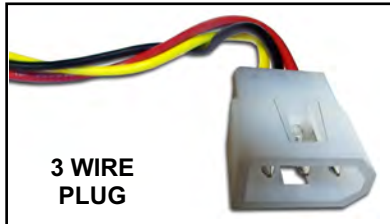

### "Calix ODC Stack"

**WINBUY # TFCLX0DC01F**  
 48V Replacement Heat Exchanger for  
 Calix ODC Heat Stack  
*w/ 2 Wires &  
 Faston Connectors*

### "AFC Cabinet Stack"

**WINBUY # TFAFC67201**  
 48V Replacement Fan for  
 AFC Cabinet Heat Stack  
*w/ Power Prongs*



150 Cooper Rd. (F-15)  
 W. Berlin, NJ 08091

[www.tagcords.com](http://www.tagcords.com)

Telephone: (856) 753-8585  
 Fax : (856) 768-7645

**Telecom Assistance Group**

## OSP Cabinet Replacement Fans

### "OPAC / OPM"

**WINBUY # TFNT0PAC**  
 48 Volt Replacement Fan for  
**Nortel Opac / OPM Cabinet**  
 w/ Round Weatherproof Connector

*(Replaces Nortel # A0381740 / # A33230 (-51)),  
 Fits first generation  
 Access Node 800A heat exchangers*

*(fan only - use with existing guard grill)*

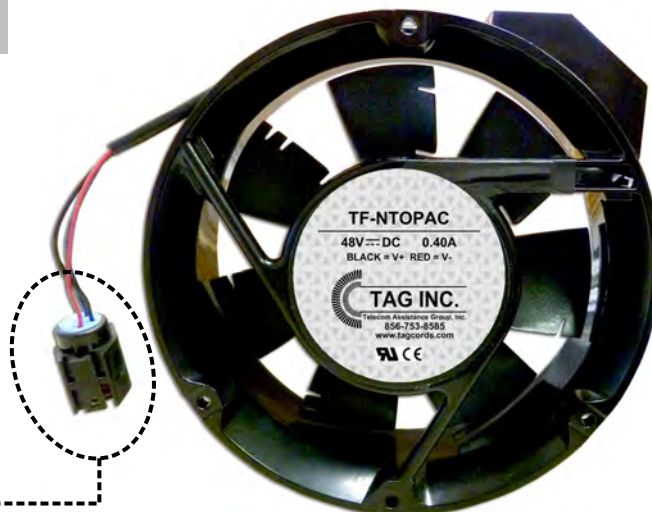

**WEATHERPROOF  
 CONNECTOR**  
 on PN # TFNT0PAC

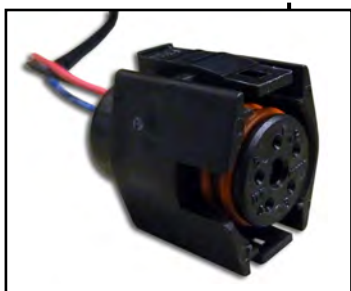

**Looking for fans w/ sealed 3 pin plugs?**



(PN # TFNT0PAC04 - CALL)



(WINBUY # TFNT0PAC02)

#### Ordering Information:

**48V Replacement Fan for Nortel Opac / OPM Cabinet  
 w/ Round Weatherproof Connector**  
*(Replaces Nortel # A0381740 / # A33230 (-51)), Fits first generation Access Node 800A heat exchangers*

**WINBUY #  
 TFNT0PAC**

**48V Replacement Fan for Nortel Opac / OPM Cabinet - (not shown)  
 w/ 3 Wire Open End (no connector)**  
*(Splicing Replacement option for both Access Node 800A & OPAC Cabinets)*

**TFNT0PAC3**

**48V Replacement Fan for Nortel Opac / OPM Cabinet  
 w/ Sealed 3 Pin Plug** *(Replaces Nortel # A0640820 / # A33230 (-51))*

**TFNT0PAC02**

#### **Also Available:** *(call for pricing)*

**48V Replacement Fan for Nortel Opac / OPM Cabinet  
 w/ Sealed 3 Pin Plug** *(Used with NT7A6986 adapter)*

**TFNT0PAC04**

**Guard Grill Replacement Kit for Round 162mm Fans** *(includes hardware) - (not shown)*

**TFG162KIT01**

150 Cooper Rd. (F-15)  
 W. Berlin, NJ 08091

[www.tagcords.com](http://www.tagcords.com)

Telephone: (856) 753-8585  
 Fax : (856) 768-7645

**Telecom Assistance Group**

# OSP Cabinet Replacement Fans

## "DMS-100 OPM BFU / DMS-1 URBAN"

*(Not for use in Nortel Access Node Fan Trays)*

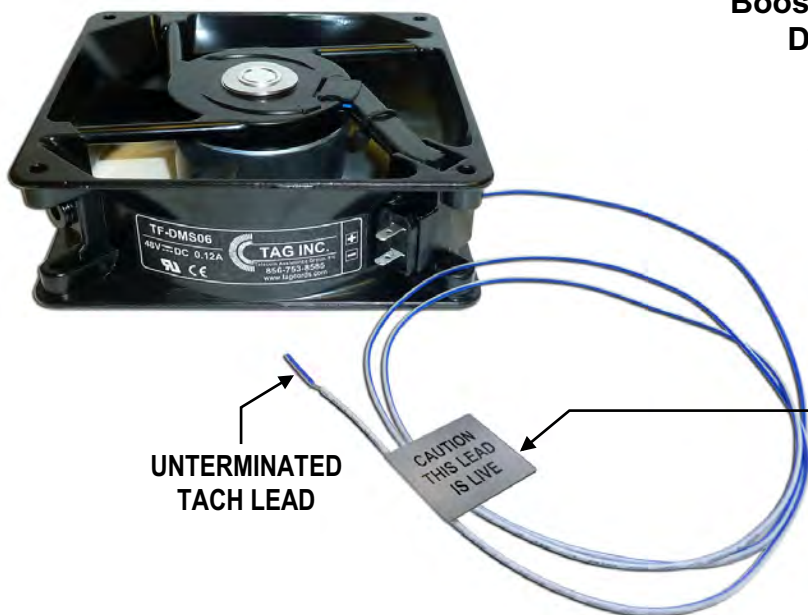

UNTERMINATED TACH LEAD

CAUTION THIS LEAD IS LIVE

CAUTION THIS LEAD IS LIVE

DO NOT REMOVE UNTIL HOOKUP

**WINBUY # TFDMS06**  
 48V Replacement Fan for  
 Booster Fan Unit (BFU) found in  
 DMS-100 OPM Cabinets

*w/ Power Prongs,  
 Unterminated Tach Lead  
 & (1) Butt Splice*

### DMS-100 OPM CABINET BOOSTER FAN UNIT (BFU) w/ EXISTING FANS

*Also used in DMS-1  
 URBAN EMC RT BAY  
 (NT4A44AA fan unit)*



<b>Ordering Information:</b>	<b>WINBUY #</b>
48 Volt Replacement Fan for Booster Fan Unit (BFU) found in DMS-100 OPM Cabinets w/ Power Prongs, Unterminated Tach Lead & (1) Butt Splice <i>(also used in DMS-1 URBAN EMC RT BAY (NT4A44AA fan unit))</i>	<b>TFDMS06</b>

150 Cooper Rd. (F-15)  
 W. Berlin, NJ 08091

[www.tagcords.com](http://www.tagcords.com)

Telephone: (856) 753-8585  
 Fax : (856) 768-7645

**Telecom Assistance Group**

# OSP Cabinet Replacement Fans & Alarm Control Boards

## "Lucent 4A / 4B"

**WINBUY # TFSLC201**  
 48 Volt Replacement Fan for  
 SLC 2000 4A / 4B Fan Trays

w/ 5 Wire Plug

(Equiv. to KS23912L6)

(80 Type Cabinet,  
 SLC 2000 Tray - Internal)



**SLC 2000 EQUIPMENT -  
 4B FAN UNIT w/ (2) FANS**  
 (fan tray is not included)

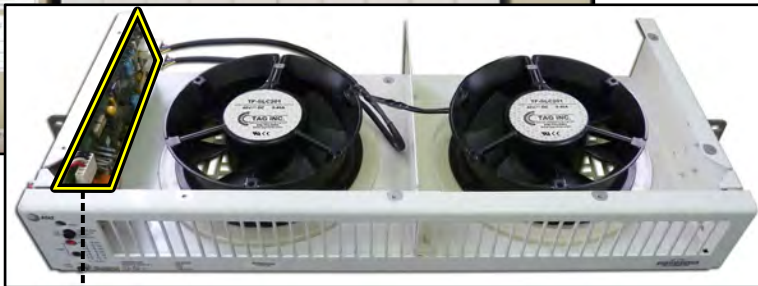
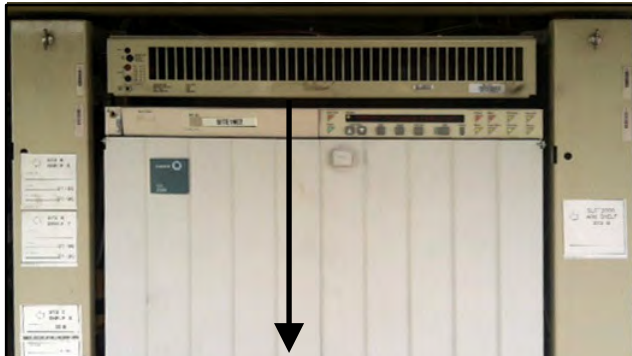

**NEW** Alarm Control Boards  
 are also available,  
 order **WINBUY # TFCLU401**



**Ordering Information:**

**48V Fan w/ 5 Wire Plug for SLC 2000 4A / 4B Fan Trays**  
 (Equiv. to KS23912L6) (80 Type Cabinet, SLC 2000 Tray - Internal)

**WINBUY #**  
**TFSLC201**

**Alarm Control Board for 4A/4B, 4G/SLC 2000 Trays & 114A Control Units**  
 (control board only - customer supplied fan trays / 114A housing)

**TFCLU401**

150 Cooper Rd. (F-15)  
 W. Berlin, NJ 08091

[www.tagcords.com](http://www.tagcords.com)

Telephone: (856) 753-8585  
 Fax : (856) 768-7645

**Telecom Assistance Group**

## OSP Cabinet Heat Exchanger Fans

### **WINBUY # TFCLX22501**

(225mm) HX Impeller Fan (**Upper**) for  
**Calix ODC Cabinet**  
w/ 4 Wire Female Snap on Plug, (14" cable)

### **PN # TF-CLX225-02 (call for pricing)**

(225mm) HX Impeller Fan (**Upper**) for  
**Calix ODC Cabinet**  
w/ 4 Wire Female Snap on Plug, (30" cable)

### **PN # TF-CLX225-03 (call for pricing)**

(225mm) HX Impeller Fan (**Lower**) for  
**Calix ODC Cabinet**  
w/ 4 Wire Male Snap on Plug, (30" cable)

### "Calix ODC - 225mm"



*(fan only,  
mounting bracket  
is not included)*



**(4) HEAT EXCHANGERS ARE MOUNTED IN THE HX UNITS ATTACHED TO THE DOORS**

### "Calix ODC - 133mm"

**WINBUY # TFCLX13301**  
(133mm) Heat Exchanger for  
**Calix ODC Cabinet**  
w/ 4 Wire Open End\*

*\*(includes (4) butt splices  
& (1) 4 pin connector)*

*(fan only,  
mounting bracket  
is not included)*

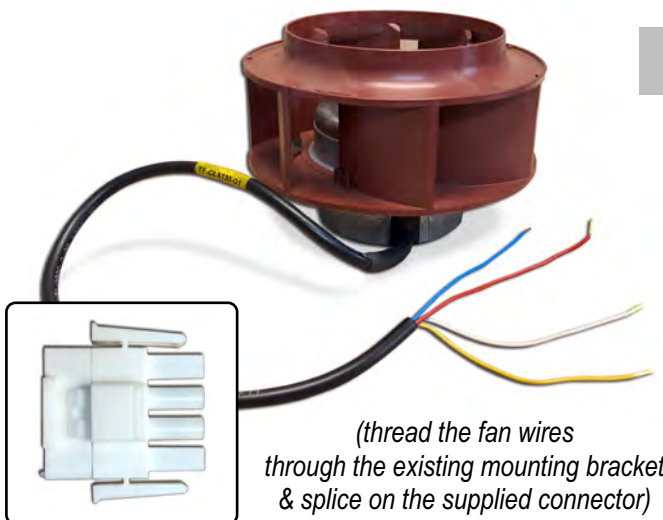

*(thread the fan wires  
through the existing mounting bracket  
& splice on the supplied connector)*

150 Cooper Rd. (F-15)  
W. Berlin, NJ 08091

[www.tagcords.com](http://www.tagcords.com)

Telephone: (856) 753-8585  
Fax : (856) 768-7645

**Telecom Assistance Group**

# Calix E7 Replacement Fans

## "Calix E7"

**WINBUY # TFCLXE701**  
12 Volt Replacement Fan for  
**Calix E7-2 FTA2 Fan Unit**  
w/ 4 Wire Plug

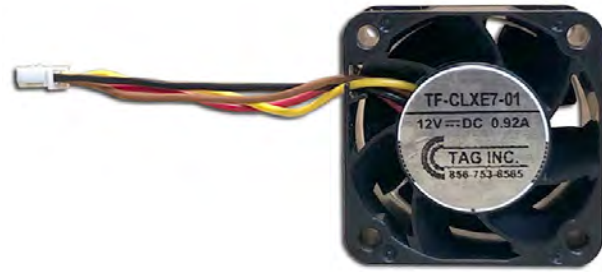

(40mm x 20mm)



(front view)

### CALIX E7-2 FTA2 FAN UNIT w/ (4) EXISTING FANS *(fan unit is not included)*



#### Ordering Information:

12V (40mm x 20mm) Replacement Fan for  
Calix E7-2 FTA2 Fan Unit w/ 4 Wire Plug

#### WINBUY #

TFCLXE701

150 Cooper Rd. (F-15)  
W. Berlin, NJ 08091

[www.tagcords.com](http://www.tagcords.com)

Telephone: (856) 753-8585  
Fax : (856) 768-7645

### Telecom Assistance Group

# OSP Cabinet Heat Exchanger Fans



## "Adtran TA5000 - Low Profile"

**WINBUY # TFTA5KHX02**  
48V (Low Profile) Heat Exchanger for  
Adtran TA5000 Cabinet Door

w/ 4 Wire Plug

*(fan only, use with existing guard grill)*

## ADTRAN TA5000 CABINET DOOR (3 HEAT EXCHANGERS)



### Ordering Information:

48 Volt (Low Profile) Replacement Heat Exchanger  
for Adtran TA5000 Cabinet Door w/ 4 Wire Plug

**WINBUY #**  
**TFTA5KHX02**

150 Cooper Rd. (F-15)  
W. Berlin, NJ 08091

[www.tagcords.com](http://www.tagcords.com)

Telephone: (856) 753-8585  
Fax : (856) 768-7645

## Telecom Assistance Group

# Fiber Optic Test Cord Kit 2

# FOTC-KIT2

## Fiber Optic Test Cords Included in Kit:

*Carrying Case included with Kit*



**(2) 430773UAM-03**  
SC/APC to LC/UPC, Singlemode Simplex, 3.0mm yellow, Test Cord, 3 Meters



**(2) 430766AAM-03**  
SC/APC to SC/APC, Singlemode Simplex, 3.0mm yellow, Test Cord, 3 Meters



**(2) 430773AAM-03**  
SC/APC to LC/APC, Singlemode Simplex, 3.0mm yellow, Test Cord, 3 Meters



**(2) 430766AM-03**  
SC/APC to SC/UPC, Singlemode Simplex, 3.0mm yellow, Test Cord, 3 Meters



**(2) 430779AM-03**  
SC/APC to ST/UPC, Singlemode Simplex, 3.0mm yellow, Test Cord, 3 Meters



**(2) 430770AM-03**  
SC/APC to FC/UPC, Singlemode Simplex, 3.0mm yellow, Test Cord, 3 Meters



**(2) 430778AM-03**  
SC/APC to D4/UPC, Singlemode Simplex, 3.0mm yellow, Test Cord, 3 Meters

## Fiber Optic Adapters Included in Kit:

- (1) 400766C**  
SC to SC  
Simplex  
UPC Coupler
- (1) 400766AC**  
SC to SC  
Simplex  
APC Coupler
- (1) 400781C**  
LC to LC  
Simplex  
UPC Coupler
- (1) 400781AC**  
LC to LC  
Simplex  
APC Coupler



- (1) 400758C**  
ST to ST  
Simplex  
UPC Coupler



- (1) 400752C**  
FC to FC  
Simplex  
UPC Coupler



- (1) 400756C**  
D4 to D4  
Simplex  
UPC Coupler



## Ordering Information:

**MODEL # FOTC-KIT2**

**Call for Pricing**

**Fiber Optic Test Cord Kit 2**

includes: (14) Cords & (7) Adapters & (1) Carrying Case *(not shown)*

*Cords can also be ordered separately in a variety of lengths & colors*

150 Cooper Rd. (F-15)  
W. Berlin, NJ 08091

[www.tagcords.com](http://www.tagcords.com)

**Telecom Assistance Group**

Telephone: (856) 753-8585

Fax: (856) 768-7645

# TAG - Fiber (VFL) Visual Fault Locator

**For 2.5mm & 1.25mm Connectors - Including SC, ST, FC & LC**

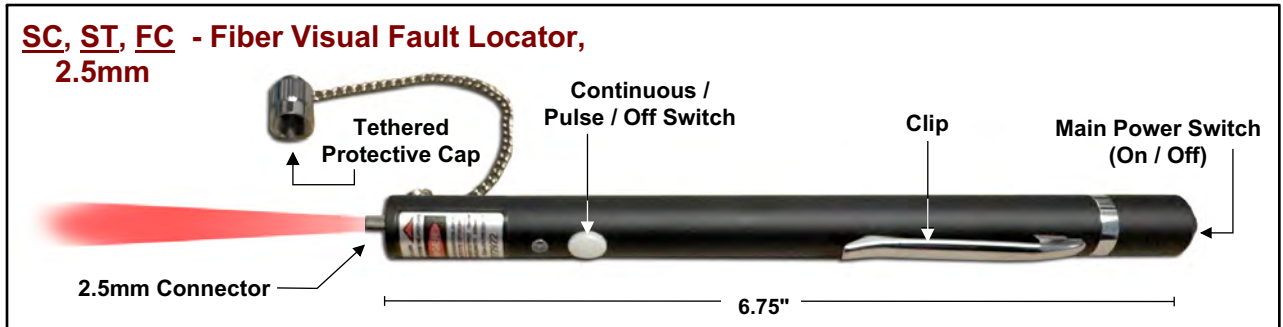
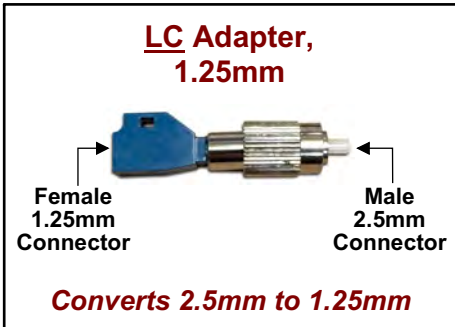
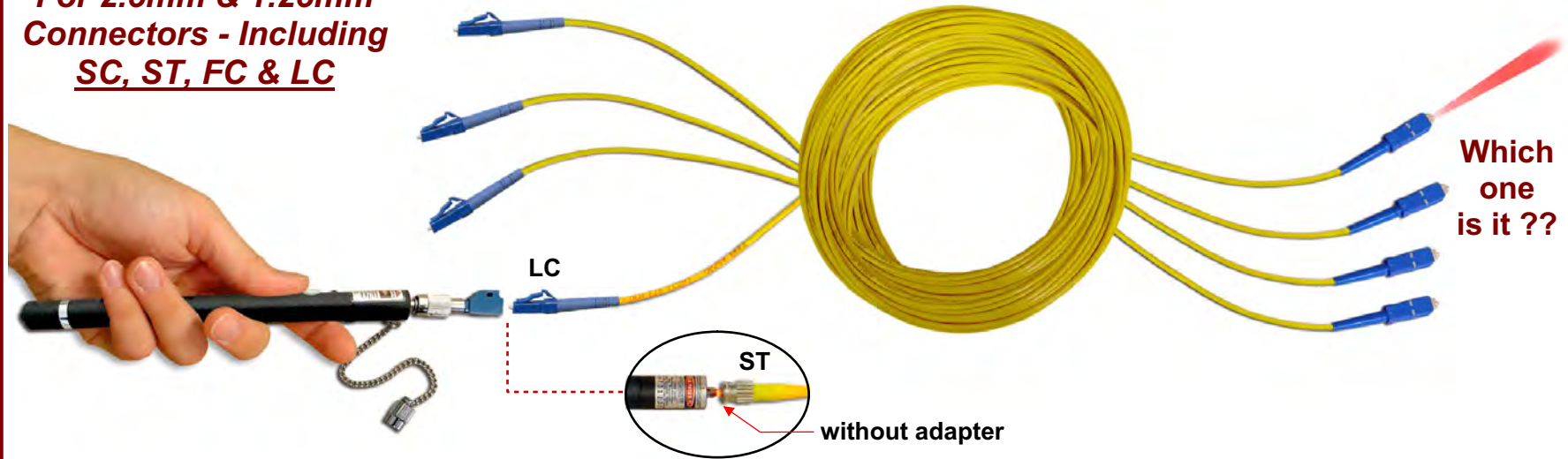

- ▶ Continuous and pulsed operation modes
- ▶ High visibility up to 3 km
- ▶ Includes Carrying Case

**Ordering Information:**

**TAG - Fiber (VFL) Visual Fault Locator (for 1.25mm & 2.5mm connectors)**  
includes: (1) VFL Unit & (1) Adapter, (1) Protective Carrying Case & (2) AAA batteries

**WINBUY #  
TFS210**

150 Cooper Rd. (F-15)  
W. Berlin, NJ 08091

www.tagcords.com  
**Telecom Assistance Group**

Telephone: (856) 753-8585  
Fax : (856) 768-7645

# Fiber Optic Test Cord Kit

# FOTCKIT

## Fiber Optic Test Cords Included in Kit:

*Carrying Case included with Kit*

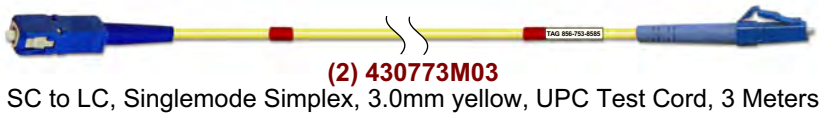
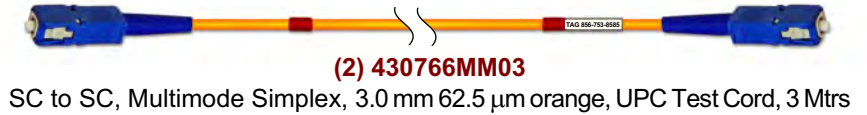
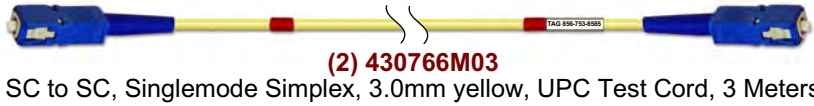

## Fiber Optic Adapters Included in Kit:



- |   |  |  |  |
|---|--|--|--|
| (1) <b>WINBUY #</b><br><b>400766C</b><br>SC to SC<br>Simplex<br>UPC Coupler | (1) <b>WINBUY #</b><br><b>400766AC</b><br>SC to SC<br>Simplex<br>APC Coupler | (1) <b>400781C</b><br>LC to LC<br>Simplex<br>UPC Coupler | (1) <b>WINBUY #</b><br><b>400781AC</b><br>LC to LC<br>Simplex<br>APC Coupler |
|---|--|--|--|



- |  |  |  |
|--|--|--|
| (1) <b>400758C</b><br>ST to ST<br>Simplex<br>UPC Coupler | (1) <b>400752C</b><br>FC to FC<br>Simplex<br>UPC Coupler | (1) <b>400756C</b><br>D4 to D4<br>Simplex<br>UPC Coupler |
|--|--|--|



## Ordering Information:

### Fiber Optic Test Cord Kit

includes: (20) Test Cords, (7) Adapters & (1) Carrying Case

**WINBUY #**  
**FOTCKIT**

150 Cooper Rd. (F-15)  
W. Berlin, NJ 08091

www.tagcords.com

**Telecom Assistance Group**

Telephone: (856) 753-8585  
Fax: (856) 768-7645