

TT-SCA1631 Quick Guide

QUICK GUIDE FOR TT-SCA1631 SINGLE SESSION TERMINAL

CONTENTS:

TERMINAL CONFIGURATION	Page 1
TERMINAL COMMAND KEYS	Page 2
TERMINAL SETUP	Page 3
CHANGING THE SERIAL PORT SETTINGS	Page 4
CHANGING THE HOST SETTINGS	Page 4
PROGRAMMING FUNCTION KEYS	Page 5
CHANGING THE SCREEN TITLE	Page 6
DEFAULT SETTINGS & FUNCTION KEYS FOR TT-SCA1631	Page 7



TT-SCA1631 Quick Guide

TERMINAL CONFIGURATION

FIGURE 1

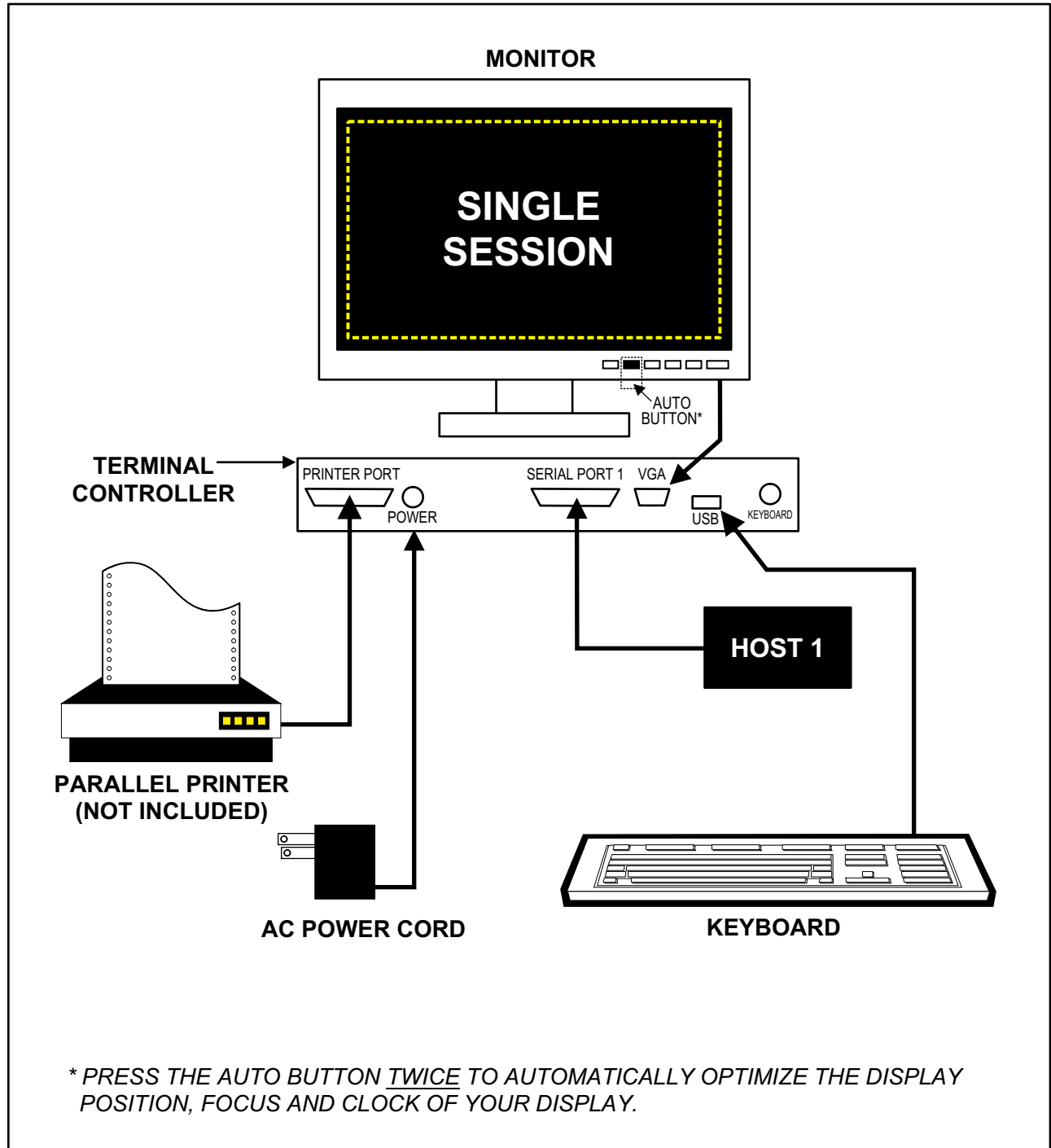



** PRESS THE AUTO BUTTON TWICE TO AUTOMATICALLY OPTIMIZE THE DISPLAY POSITION, FOCUS AND CLOCK OF YOUR DISPLAY.*

TT-SCA1631 Quick Guide

TERMINAL COMMAND KEYS

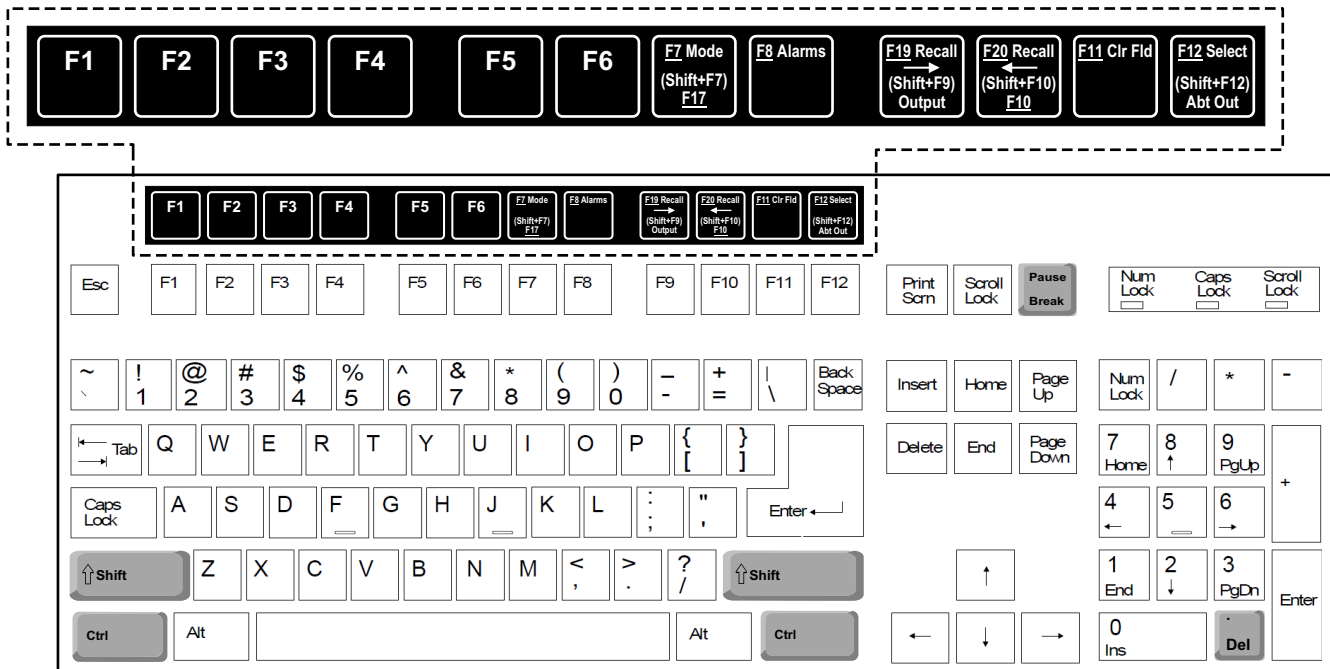
FIGURE 2

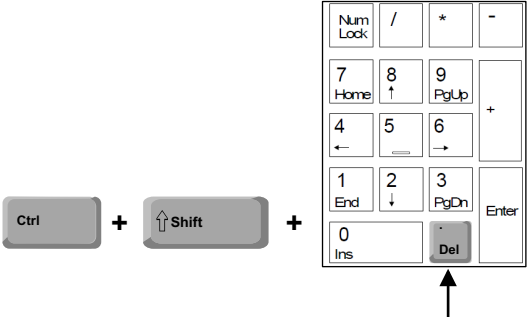

<p>PRINT</p>	<p>Press Ctrl + Shift + • (Decimal on the Number Pad)</p> 
<p>SEND BREAK</p>	<p>Press Ctrl + Pause/Break Key</p> 

Note:























The following pages show how to make adjustments to the terminal when required.

TT-SCA1631 Quick Guide

TERMINAL SETUP

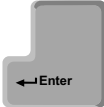
FIGURE 3

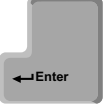
FIGURE 4

ENTER SETUP SCREEN	Press Ctrl + Scroll Lock	 + 
SELECT MENU	Press F1 - Prt Scn (see pg. 7 for Default Setup)	            
NAVIGATE PARAMETERS	Press the Arrow Keys	   
NAVIGATE CHOICES	Press Enter or Spacebar (moves forward)	 or 
	Press Shift + Enter (moves backward)	 + 
EXIT SETUP SCREEN	Press the Pause Key (when prompted to "Save all", press Y key to Save or N key to discard)	

TT-SCA1631 Quick Guide

CHANGING THE SERIAL PORT SETTINGS

FIGURE 5

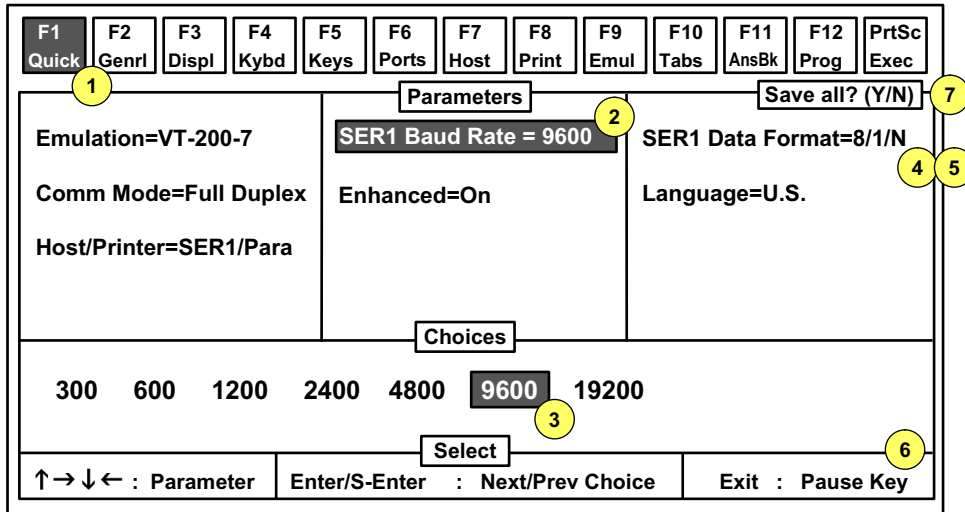

1. Press the **F1** button
2. Use the **Arrow Keys** to move to **SER1 Baud Rate (SER1 = Serial Port 1)**
3. Press **Enter** or **Spacebar** until the correct **Choice** is highlighted
4. Use the **Arrow Keys** to move over to **SER1 Data Format**
5. Press **Enter** or **Spacebar** until the correct **Choice** is highlighted
6. When finished, press the **Pause Key** at the top right of the keyboard
7. When prompted with "**Save all?**", click **Y** to save the new **Parameters**

CHANGING THE HOST SETTINGS

FIGURE 6

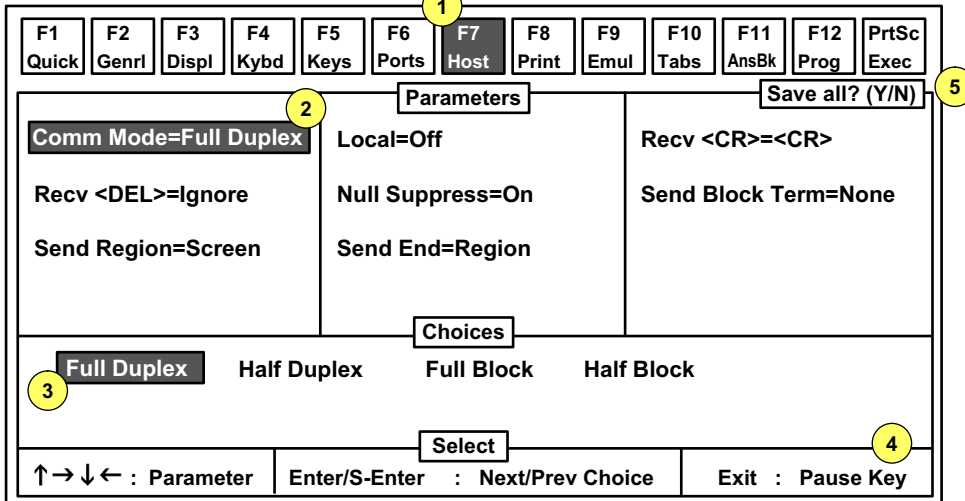

1. Press the **F7** button
2. Use the **Arrow Keys** to move over to **Comm Mode**
3. Press **Enter** or **Spacebar** until the correct **Choice** is highlighted
Note: The common setting is either Full Duplex or Full Block
4. When finished, press the **Pause Key** at the top right of the keyboard
5. When prompted with "**Save all?**", click **Y** to save the new **Parameters**

TT-SCA1631 Quick Guide

PROGRAMMING FUNCTION KEYS*

Note: Function Keys for this Terminal have been set for 1631[®] DACS.

The following instructions show how to modify a function key output if required.

*Each function key has (4) programmable registers per session such as **F/key**, **sh-F/key**, **ctrl-F/key** & **ctrl-sh-F/key** (These can be selected from the "Choices" located in the **"Program"** Parameter)

FIGURE 7

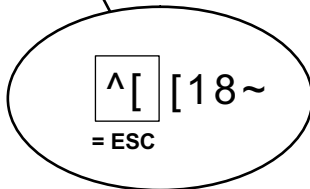
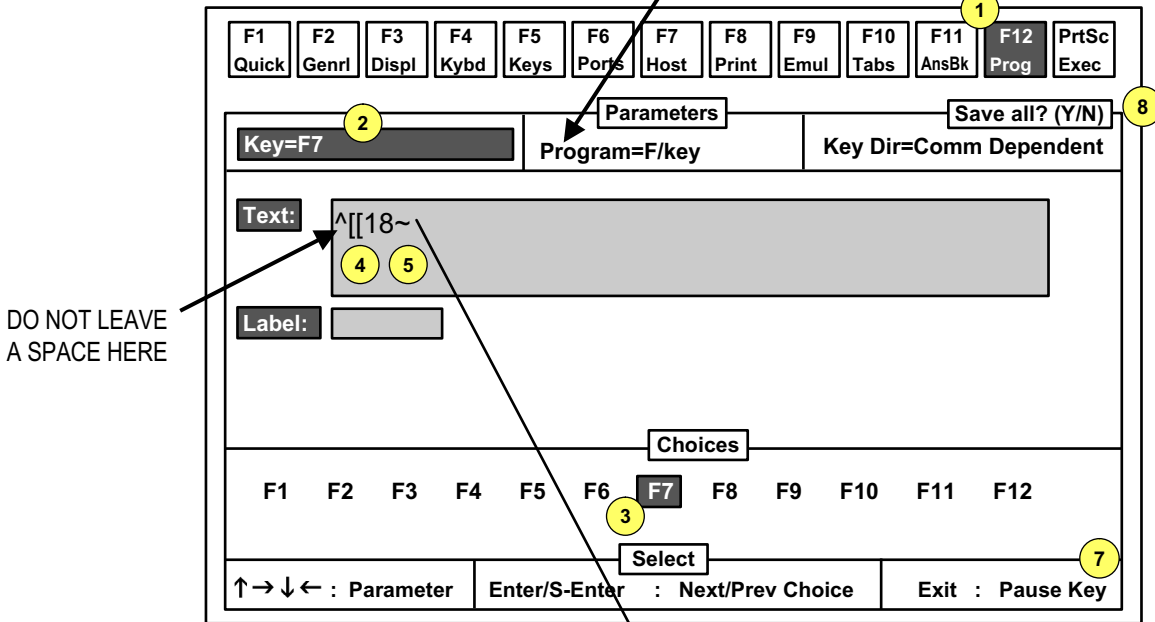

Note:
For ^ press Shift+6

1. Press the **F12** button
2. The cursor will appear in the "Key" Field with F1 as the default
3. Select a new function key to program by pressing **Enter** or **Spacebar** until the correct **Choice** is highlighted (for example choose F7)
4. Arrow down to move to the "Text" Field
5. Type in the "Function" for the key. CAUTION: The first character in the Text Field cannot be left blank
Example: To program **ESC[18~** Type: **Shift+6** **[[18** **Shift+`** = (**^[[18~**)
6. To program another function, arrow back up to the "Key" Field & repeat steps 3-5
7. When finished, press the **Pause Key** at the top right of the keyboard
8. When prompted with **"Save all?"**, click **Y** to save the new **Parameter**

TT-SCA1631 Quick Guide

CHANGING THE SCREEN TITLE

Note: This will change the title at the top of the Session.

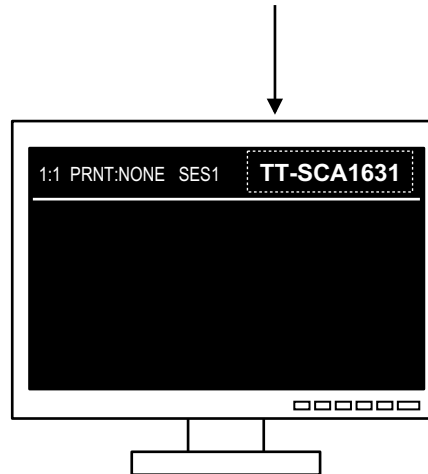

DISPLAY ON MONITOR

FIGURE 8

F1 Quick	F2 Genrl	F3 Displ	F4 Kybd	F5 Keys	F6 Ports	F7 Host	F8 Print	F9 Emul	F10 Tabs	F11 AnsBk	F12 Prog	PrtSc Exec
Parameters											Save all? (Y/N)	
Answerback Mode=Off				Answerback Conceal								
Answerback Message: <input type="text"/>												
Screen Title: <input type="text" value="TT-SCA1631_"/>												
Choices												
<Backspace> : Delete Character <Shift><Backspace> : Default Field												
Select												
↑→↓← : Parameter				Enter/S-Enter : Next/Prev Choice				Exit : Pause Key				

1. Press the **F11** button
2. Use the **Arrow Keys** to move the cursor down to **Screen Title**
3. Type in a Title for the Session (Example: TT-SCA1631)
4. When finished, press the **Pause Key** at the top right of the keyboard
5. When prompted with "**Save all?**", click **Y** to save the new **Parameters**

TT-SCA1631 Quick Guide

DEFAULT SETTINGS & FUNCTION KEYS FOR TT-SCA1631

Note: Items in **Bold** may require Local Settings.

FIGURE 9

Menu	Key	Parameters Available (Not all will display for a given emulation, keyboard, or video mode)		
Quick	F1	Emulation = VT-200-7 Comm Mode = Full Duplex Host/Printer = SER1/Para	SER1 Baud Rate = 9600 Enhanced = On	SER1 Data Format = 8/1/N Language = U.S.
General	F2	Emulation = VT-200-7 Screen Saver = Off Warning Bell = On Host/Printer = SER1/Para	Enhanced = On Auto Page = Off Bell Length = 350 ms	Auto Wrap = On Auto Scroll = On Bell Volume = 0
Display	F3	Page Length = 24 Display Cursor = On Columns = 80	Screen Length = 26 Lines Cursor = Blink Block Erase Color = Black	Screen Video = Normal Auto Adjust Cursor = On Scroll Speed = Full
Keyboard	F4	Language = U.S. Key Click = On Num Lock = Toggle	Char Set Mode = ANSI Key Repeat = Off Key Lock = Reverse	Margin Bell = Off Key Rate = 20 cps Caps Lock = Toggle
Keys	F5	Enter Key = <CR> Alt Key = Compose UDKS = Emul Dependent	Return Key = <CR> Disconnect = Pause	Backspace = <BS>/<BS> Return Key Repeat = Off
Ports	F6	SER1 Baud Rate = 9600 SER1 Xmt = No Protocol SER1 Break = 250 ms	SER1 Data Format = 8/1/N SER1 Recv = No Protocol SER1 Modem Control = Off	SER1 Parity Check = Off SER1 Xmt Pace = Baud SER1 Disconnect = 2 sec
Host	F7	Comm Mode = Full Duplex Recv = Ignore Send Region = Scroll	Local = Off Null Suppress = On Send End = Region	Recv <CR> = <CR> Send Block Term = None
Print	F8	Prnt Mode = Normal	Prnt Region = Screen	Prnt Block = None
Emulation	F9	Numeric Kpd = Numeric ANSI-ID = VT-220 Status Line = Indicator	Cursor Kpd = Cursor Feature Lock = Off	Send Data = All Function Key Lock = Off
Tabs	F10	Auto Init Tabs = Off	Default Tabs	
Answerback	F11	Answerback Mode = Off Screen Title: TT-SCA1631	Answerback Conceal	
Program	F12	Key = F6 (see TABLE 1 below) Text: rst:aivlc	Program = F/Key	Key Dir = Comm Dependent
Execute	Prt Sc	Save Terminal Reset Terminal Clear Screen	Recall Terminal Default Session UDKS Terminal Version	Default Terminal Reset Ports Update Terminal
Exit Setup	Pause	Save all? (Y/N)		

TABLE 1
FUNCTION KEYS

F6 =	rst:aivlc	SHIFT F7 =	^[[31~
F7 =	^[[18~	SHIFT F8 =	
F8 =	^[[19~	SHIFT F9 =	^[[20~
F9 =	^[[33~	SHIFT F10 =	^[[21~
F10 =	^[[34~	SHIFT F11 =	
F11 =	^[[23~	SHIFT F12 =	^[[24~
F12 =	^[[4~		