

2024

# Central Office Tools for AT&T

Provided By:



*The "Cord Company" and more . . .*

For a Complete  
PID / OIN List & Catalog visit:  
[www.tagcords.com](http://www.tagcords.com)  
or email:  
[custsvcs@tagcords.com](mailto:custsvcs@tagcords.com)

## REPLACEMENT TERMINALS

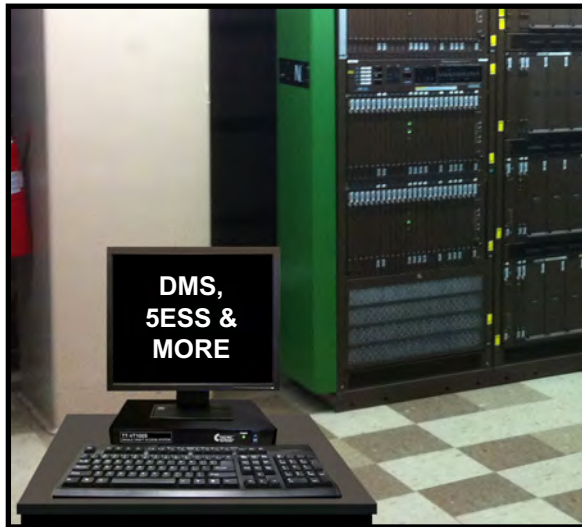

## SPECIALTY TEST CORDS

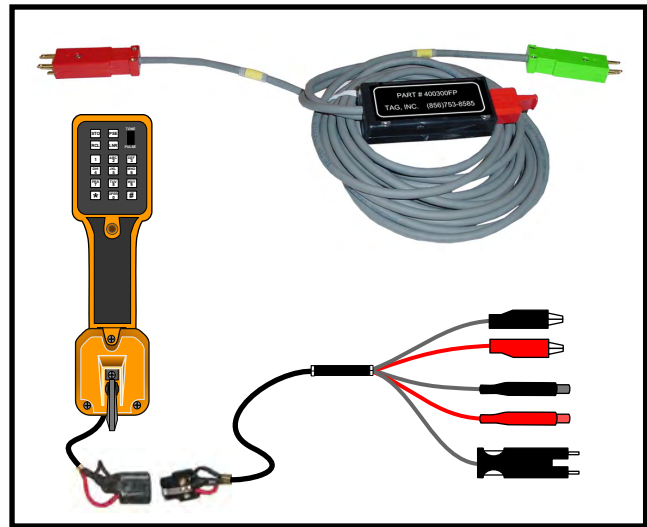

- **NEW Replacement Terminals** (DMS, 5ESS, Transport / DACS & More)
- **Portable HDSL "Smart Jacks"** (for 2W & 4W Cards, 220 Mech.)
- **"Froggers" & Coax**
- **Multi-Cords** (Quick Disconnect)

# 856-753-8585

# CO Portable HDSL "Hot Shoe" Kit

*The CO Portable HDSL "Hot Shoe" Kit is Designed for Central Offices*

- ▶ 4 Slots for 200/400 Mech. HDSL "R" Cards
- ▶ Rugged Connectors

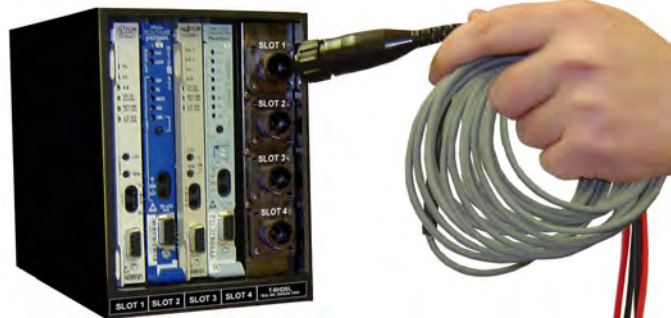

(cards not included)

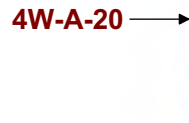

**A VARIETY OF 20' CORDS ARE AVAILABLE!!**  
(see the following page for 463A cord & others)

Leave the Portable HDSL Unit on the floor & **SAFELY CLIMB CO LADDERS**

### Ordering Information:

**RHDSL-HDCO-01 CO Portable HDSL "Hot Shoe" Kit**  
 includes: (1) T-RHDSL, (1) 4W-A-20 &  
 (1) 600509 - carrying case

**AT&T PID # (KIT)**  
**ATT.100090480**

150 Cooper Rd. (F-15)  
 W. Berlin, NJ 08091

www.tagcords.com  
**Telecom Assistance Group**

Telephone: (856) 753-8585  
 Fax: (856) 768-7645

## 20' - 4W Frame Cords for Central Office Portable "R" - HDSL Test Unit

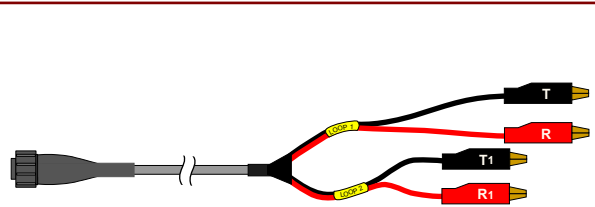

**4W-A-20**  
Female Lock Plug to  
(4) Std Alligator Clips, (20')

**AT&T PID # ATT.100090481**

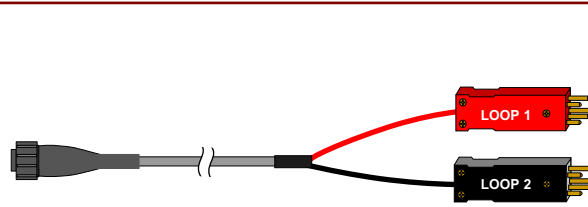

**4W-463Y-20**  
Female Lock Plug to  
Protector "Y", (20')

**AT&T PID # ATT.100090482**

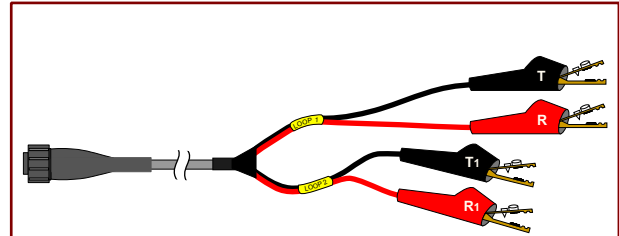

**4W-6P-20**  
Female Lock Plug to  
(4) 6P Alligator Clips, (20')

**AT&T PID # ATT.100090483**

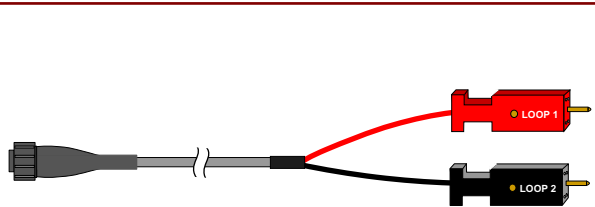

**4W-PORTY-20**  
Female Lock Plug to  
Porta "Y", (20')

**AT&T PID # ATT.100090484**

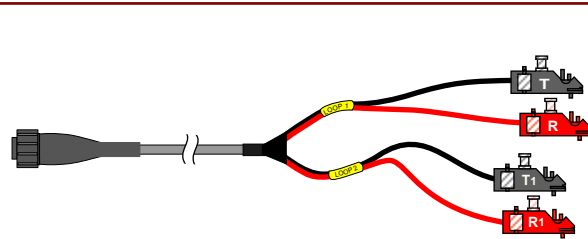

**4W-252Y-20**  
Female Lock Plug to  
252 "Y" Plugs, (20')

**AT&T PID # ATT.100090485**

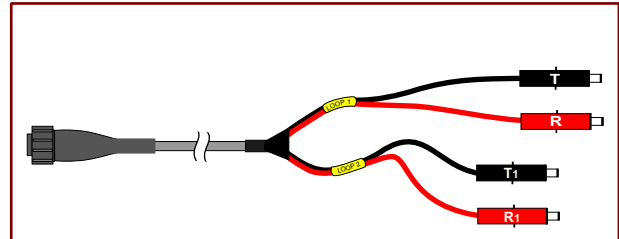

**4W-412Y-20**  
Female Lock Plug to  
412 "Y" Plugs, (20')

**AT&T PID # ATT.100090486**

*- All Cords are available in other lengths -*

150 Cooper Rd. (F-15)  
W. Berlin, NJ 08091

[www.tagcords.com](http://www.tagcords.com)  
**Telecom Assistance Group**

Telephone: (856) 753-8585  
Fax : (856) 768-7645

# Portable "R" - HDSL Test Unit Kit

# RHDSL-BST01

**RHDSL-BST01**  
**Portable "R" -**  
**HDSL Test Unit Kit**

<b>12 STATE (KIT)</b>	<b>SOUTHEAST (KIT)</b>
<b>ATT.100071972</b>	<b>ATT.100011889</b>



**(1) 600509**  
 Carrying Case



↑  
 (cards not included)



- ▶ **4 Slots for 200/400 Mech. HDSL "R" Cards**
- ▶ **Rugged Connectors**
- ▶ **Various Test Cords**

**(1) 4W-6P-08**  
 Female Lock Plug to  
 (4) 6P Alligator Clips, (8')

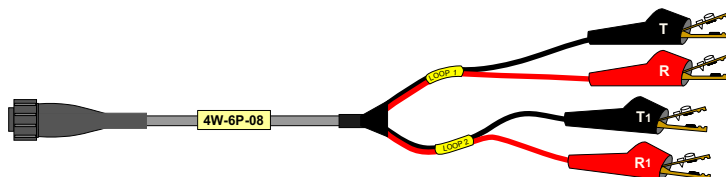

**(1) 4W-463Y-08**  
 Female Lock Plug to  
 5 Pin "Y" Protector, (8')

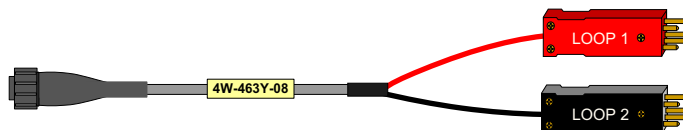

### Ordering Information:

		<b>12 STATE (KIT)</b>	<b>SOUTHEAST (KIT)</b>
		<b>ATT.100071972</b>	<b>ATT.100011889</b>
<b>RHDSL-BST01</b>	<b>Portable "R" - HDSL Test Unit Kit</b> includes: (1) T-RHDSL, (1) 4W-6P-08, (1) 4W-463Y-08 & (1) 600509		
<b>T-RHDSL</b>	<b>Portable "R" HDSL Test Unit</b> <i>(requires test cords)</i>	<b>ATT.100071981</b>	<b>ATT.100011557</b>
<b>4W-463Y-08</b>	<b>Lock Plug (F) to 5 Pin "Y" Protector, (8')</b>	<b>ATT.100039928</b>	<b>ATT.100011859</b>
<b>4W-6P-08</b>	<b>Lock Plug (F) to (4) 6P Alligator Clips, (8')</b>	<b>AT&amp;T PID #</b>	
<b>600509</b>	<b>Carrying Case</b>	<b>ATT.100022122</b> <b>ATT.100001661</b>	

**\*\* Cords are Required for Testing \*\***

150 Cooper Rd. (F-15)  
 W. Berlin, NJ 08091

[www.tagcords.com](http://www.tagcords.com)

**Telecom Assistance Group**

Telephone: (856) 753-8585  
 Fax: (856) 768-7645

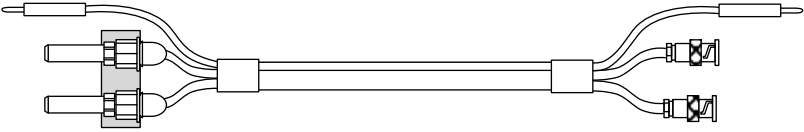
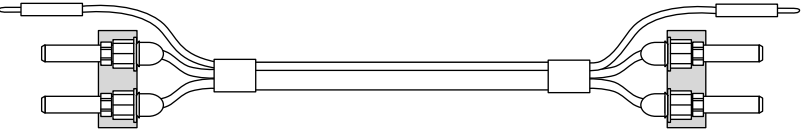
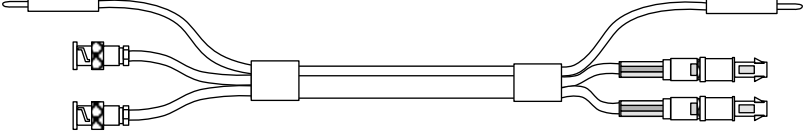
FEATURES / APPLICATION	DESCRIPTION	PART #	PID #
<b>DSX-3/4 Patch / Test Cord w/ Tracer ("messenger") Wire</b>  <ul style="list-style-type: none"> <li>A convenient way of patching Tx &amp; Rx circuits at the same time</li> <li>Available in all lengths</li> </ul>	Dual 440D to Dual BNC w/ tracer, (15')	<b>B00440DR-15</b>	<b>ATT.100038521</b>
	Dual 440D to Dual BNC w/ tracer, (25')	<b>B00440DR-25</b>	<b>ATT.100041988</b>
	Dual 440D to Dual BNC w/ tracer, (36')	<b>B00440DR-36</b>	<b>ATT.100041989</b>
			
<b>DSX-3/4 Patch / Test Cord w/ Tracer ("messenger") Wire</b>  <ul style="list-style-type: none"> <li>A convenient way of patching Tx &amp; Rx circuits at the same time</li> <li>Available in all lengths</li> </ul>	Dual 440D to Dual 440D w/ tracer, (6')	<b>400440DD-06</b>	<b>CALL</b>
	Dual 440D to Dual 440D w/ tracer, (14')	<b>400440DD-14</b>	<b>CALL</b>
	Dual 440D to Dual 440D w/ tracer, (25')	<b>400440DD-25</b>	<b>CALL</b>
	Dual 440D to Dual 440D w/ tracer, (32')	<b>400440DD-32</b>	<b>CALL</b>
			
<b>DSX-3/4 Patch / Test Cord w/ Tracer ("messenger") Wire</b>  <ul style="list-style-type: none"> <li>A convenient way of patching Tx &amp; Rx circuits at the same time</li> <li>Available in all lengths</li> </ul>	Dual BNC to Dual LCC Loopback	<b>400470CB-LP</b>	<b>CALL</b>
	Dual BNC to Dual LCC w/ tracer, (5')	<b>400470CB-05</b>	<b>CALL</b>
	Dual BNC to Dual LCC w/ tracer, (15')	<b>400470CB-15</b>	<b>CALL</b>
	Dual BNC to Dual LCC w/ tracer, (20')	<b>400470CB-20</b>	<b>CALL</b>
	Dual BNC to Dual LCC w/ tracer, (30')	<b>400470CB-30</b>	<b>CALL</b>
			

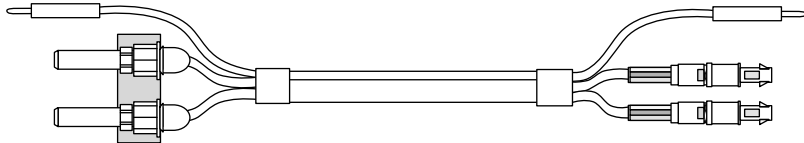
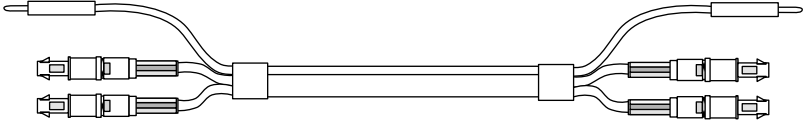
FEATURES / APPLICATION	DESCRIPTION	PART #	PID #	
<b>DSX-3/4 Patch/Test Cord w/ Tracer ("messenger") Wire</b> <ul style="list-style-type: none"> <li>A convenient way of patching Tx &amp; Rx circuits at the same time</li> <li>Available in all lengths</li> <li>Locking Tabs &amp; Spanners</li> </ul>	Dual 440D to Dual LCC Loopback	<b>400470CD-LP</b>	<b>CALL</b>	
	Dual 440D to Dual LCC w/ tracer, (3')	<b>B00470CD-03</b>	<b>ATT.100041990</b>	
	Dual 440D to Dual LCC w/ tracer, (5')	<b>B00470CD-05</b>	<b>ATT.100038523</b>	
	Dual 440D to Dual LCC w/ tracer, (6')	<b>400470CD-06</b>	<b>CALL</b>	
	Dual 440D to Dual LCC w/ tracer, (12')	<b>400470CD-12</b>	<b>CALL</b>	
	Dual 440D to Dual LCC w/ tracer, (20')	<b>400470CD-20</b>	<b>CALL</b>	
	Dual 440D to Dual LCC w/ tracer, (24')	<b>B00470CD-24</b>	<b>ATT.100041991</b>	
	Dual 440D to Dual LCC w/ tracer, (30')	<b>400470CD-30</b>	<b>CALL</b>	
	Dual 440D to Dual LCC w/ tracer, (36')	<b>B00470CD-36</b>	<b>ATT.100038522</b>	
	Dual 440D to Dual LCC w/ tracer, (45')	<b>400470CD-45</b>	<b>CALL</b>	
		<b><u>PART #</u></b>	<b><u>12 STATE</u></b>	<b><u>SOUTHEAST</u></b>
<b>DSX-3/4 Patch/Test Cord w/ Tracer ("messenger") Wire</b> <ul style="list-style-type: none"> <li>A convenient way of patching Tx &amp; Rx circuits at the same time</li> <li>Available in all lengths</li> <li>Locking Tabs</li> </ul>	Dual LCC to Dual LCC Loopback	<b>400470CC-LP</b>	<b>CALL</b>	
	Dual LCC to Dual LCC w/ tracer, (5')	<b>400470CC-05</b>	<b>CALL</b>	
	Dual LCC to Dual LCC w/ tracer, (15')	<b>400470CC-15</b>	<b>CALL</b>	
	Dual LCC to Dual LCC w/ tracer, (30')	<b>400470CC-30</b>	<b>CALL</b>	
	Dual LCC to Dual LCC w/ tracer, (45')	<b>400470CC-45</b>	<b>CALL</b>	
			<b><u>PART #</u></b>	<b><u>12 STATE</u></b>
<b>DSX-3/4 Patch/Test Cord w/ Tracer ("messenger") Wire</b>	Dual LCC to Dual 440 ( <i>custom length</i> )	<b>470CD-CONN</b>	<b>CALL</b>	
	Dual LCC to Dual LCC ( <i>custom length</i> )	<b>470CC-CONN</b>	<b>CALL</b>	
	Dual LCC to Dual BNC ( <i>custom length</i> )	<b>470CB-CONN</b>	<b>CALL</b>	

**"Green Coil Cord"****400300FP****"Frogger" Protector Test Cord, (20')**

1. Insert "Good" (green) plug into known good line.
2. Insert "Bad" (red) plug into bad line for temporary restoration.

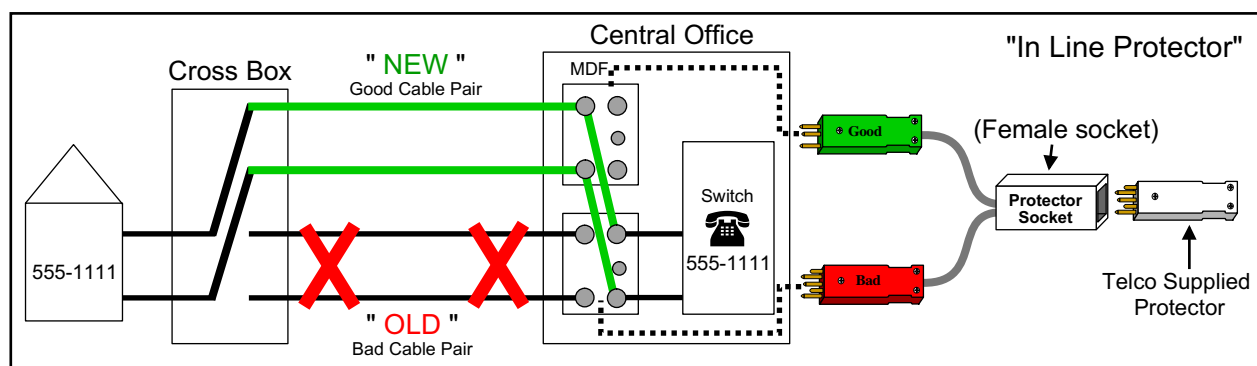
**Application:**

TAG's Temporary Restoral Cord (400300FP) allows you to add protection back to the telephone line when testing. TAG's test cord features a built-in protector socket that accepts any 5-pin protector module. A 5-pin module with the same specifications as the line you are testing on must be inserted before the test cord can function. Once inserted, the cord will now function and protection has been restored to the line.

In the event of a power or lightning strike, TAG's 400300FP can save thousands of dollars by eliminating dangers that can destroy expensive equipment or possibly harm a technician. One plug is Green "GOOD" & the other plug is Red "BAD". When the repair is made, the circuit can be identified as to which pair is good or bad.

**Ordering Information:****400300FP****"Frogger" Protector Test Cord - (20')****AT&T PID #****ATT.100111566**

150 Cooper Rd. (F-15)  
W. Berlin, NJ 08091

[www.tagcords.com](http://www.tagcords.com)

Telephone: (856) 753-8585  
Fax : (856) 768-7645

**Telecom Assistance Group**

## Remote Network Cable Tester w/ Tone Generator & CAT 5 Cables

### Simplify Network Cable Testing !!

#### Cable Test Features:

- Displays:**
- Short
  - Reversed
  - Miswired
  - Split Pairs

#### Tone Generator\* Features:

- Verification of Shield Integrity
- Puts Tracer Tone on Cable

\* Tone Generator function requires customer supplied Cable Tracing Probe

#### Additional Features:

- Specially designed Remote Unit that enables one person to test installed cables.
- Easy to read Fault Display and high speed testing.
- Debug mode for detailed fault identification results.
- Auto Sleep Mode and Power Off Switch to decrease power consumption.
- Low Battery Indicator
- Includes (4) four AAA batteries

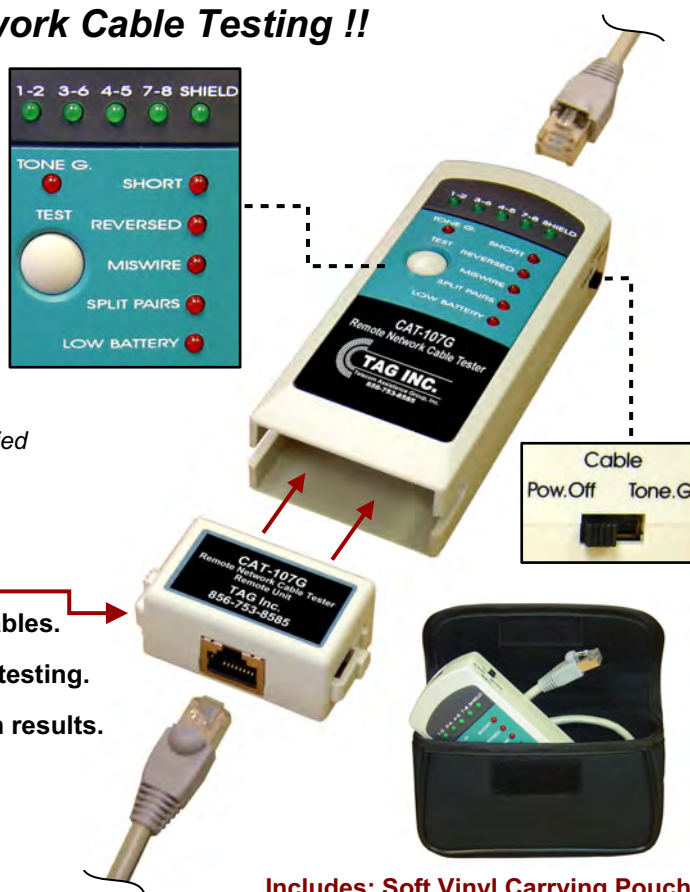

Includes: Soft Vinyl Carrying Pouch & Remote Terminating Cable

#### Ordering Information:

CAT-107G	Remote Network Cable Tester w/ Tone Generator	AT&T PID #
	includes: (1) Carrying Pouch, (1) Remote Terminating Cable & (4) AAA Batteries	ATT.100035180
RH-CAT5-10	Cat 5 Cable (RJ45 to RJ45), (10')	ATT.100111579
RH-CAT5-15	Cat 5 Cable (RJ45 to RJ45), (15')	ATT.100000977
RH-CAT5-20	Cat 5 Cable (RJ45 to RJ45), (20')	ATT.100000979
RH-CAT5-25	Cat 5 Cable (RJ45 to RJ45), (25')	ATT.100000981
RH-CAT5-30	Cat 5 Cable (RJ45 to RJ45), (30')	ATT.100000983
RH-CAT5-40	Cat 5 Cable (RJ45 to RJ45), (40')	ATT.100000985
RH-CAT5-50	Cat 5 Cable (RJ45 to RJ45), (50')	ATT.100111581
RH-CAT5-75	Cat 5 Cable (RJ45 to RJ45), (75')	ATT.100111583
RH-CAT5-100	Cat 5 Cable (RJ45 to RJ45), (100')	ATT.100000991
RH-CAT5-125	Cat 5 Cable (RJ45 to RJ45), (125')	ATT.100412390
RH-CAT5-150	Cat 5 Cable (RJ45 to RJ45), (150')	ATT.100000995
RH-CAT5-200	Cat 5 Cable (RJ45 to RJ45), (200')	ATT.100412400
RH-CAT5-250	Cat 5 Cable (RJ45 to RJ45), (250')	ATT.100412410

150 Cooper Rd. (F-15)  
W. Berlin, NJ 08091

[www.tagcords.com](http://www.tagcords.com)

Telephone: (856) 753-8585  
Fax : (856) 768-7645

**Telecom Assistance Group**



## DB9M / RS232 to USB Adapter Cable

Need access to a Serial Port on your Laptop?

**TAG's Adapter Cable will convert your Laptop's USB Port into a Serial Port!**

Serial Port on an Older Laptop

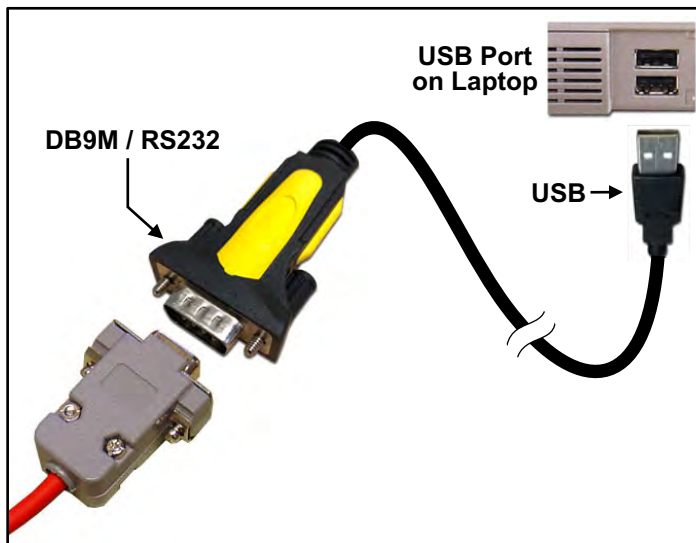

### System Requirements:

- Supports Windows® 2000 / XP / Server 2008 / Vista / 7 / 8 / 10, Linux, Mac os V8.6 or higher
- Available USB Port

### Application:

Plug the USB connector into your computer and the serial connector into your serial device to exchange files, data and more.



### Ordering Information:

**400720USB**

**DB9M/RS232 to USB Adapter Cable**

Supports Windows®2000 / XP / Server 2008 / Vista / 7 / 8 / 10, Linux, Mac os V8.6 or higher  
includes: (1) 400720USB, (1) Installation CD with User Manual

**AT&T PID #**

**ATT.100000993**

150 Cooper Rd. (F-15)  
W. Berlin, NJ 08091

[www.tagcords.com](http://www.tagcords.com)

**Telecom Assistance Group**

Telephone: (856) 753-8585

Fax: (856) 768-7645

# USB-C to DB9 Pin (male)

# 400721USBC

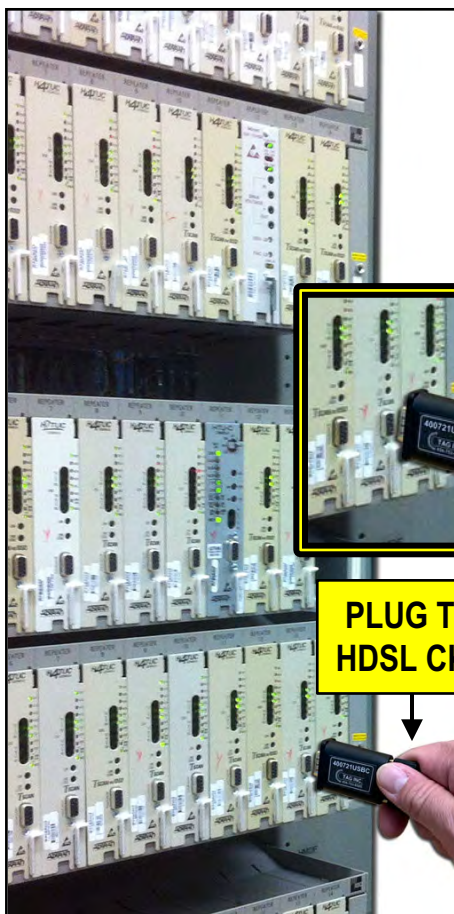

PLUG TO USB-C PORT ON LAPTOP



<b>Ordering Information:</b>		<b>AT&amp;T PID #</b>
<b>400721USBC</b>	<b>USB-C to DB9 Pin (male)</b>	<b>ATT.200009155</b>

150 Cooper Rd. (F-15)  
W. Berlin, NJ 08091

[www.tagcords.com](http://www.tagcords.com)

Telephone: (856) 753-8585  
Fax : (856) 768-7645

## Telecom Assistance Group

Telecom Assistance Group (TAG)  
856-753-8585 www.tagcords.com

# Quick Disconnect Multi-Cords

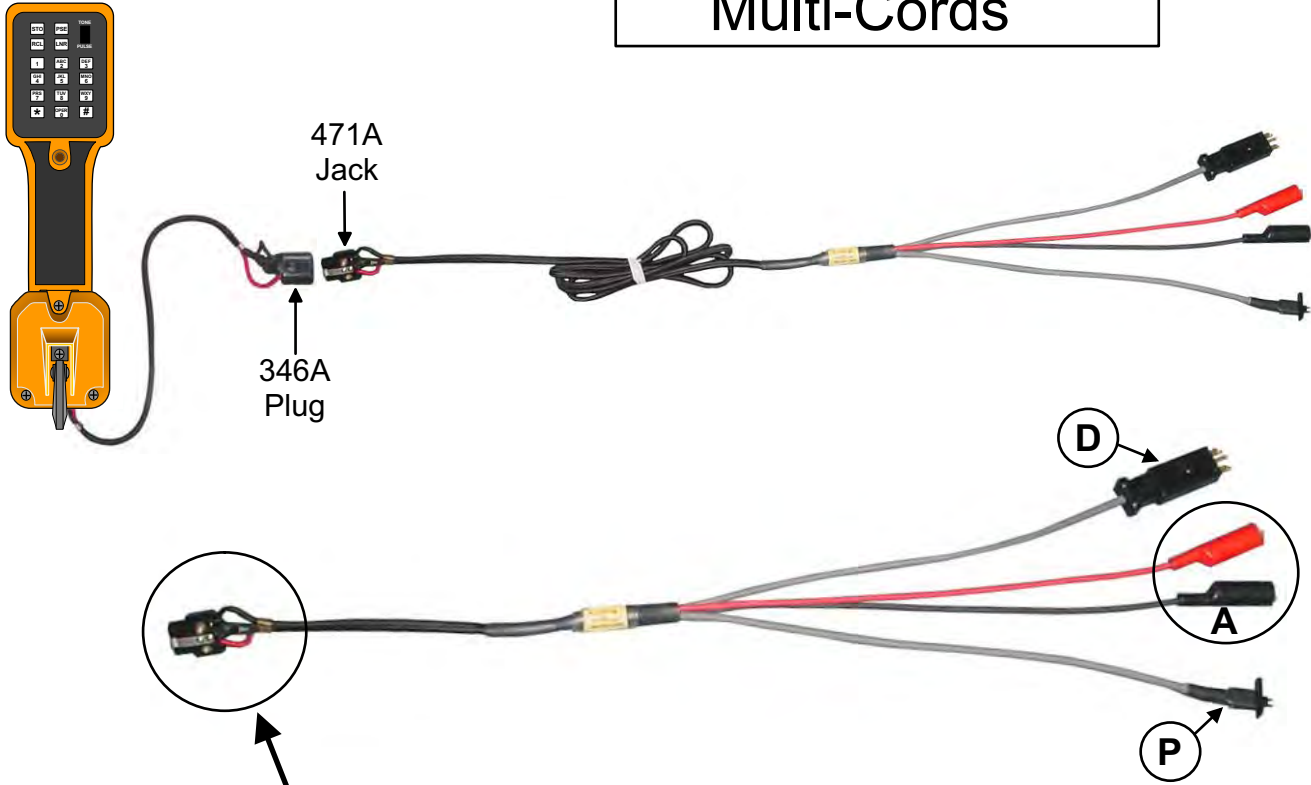

2 -   A     D     P   - 5

**Ends**  
Choose (1 to 4 Ends)

2 represents ordering code for Quick Disconnect Multi-Cord (471A Jack)

5 represents 5'  
(Call for other lengths)

Alligator	A	
Mini Test	B	
Wire Wrap	C	
Protector	D	
453A	E	
Bantam	F	
310	G	
526A	H	
88 Type (D Clip)	I	
526P (Porta)	J	
Snagless RJ11	K	
SLC 96	L	
Modular (RJ11)	M	
6P Alligator	O	
310 MDF	P	
110 Clip (C Clip)	Q	
76 Clip	R	
SLC 5	S	
360 Tools	T	
66 Blk Adapter	X	
Mini Alligator	Y	
Porta	Z	

# D4 Monitor Cord, (5')

# 400480MHS

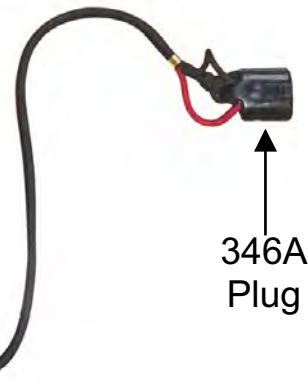
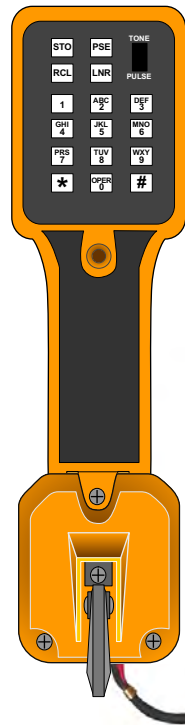

346A Plug

**PN # 400480MHS**  
**D4 Monitor Cord, (5')**



471A Plug

D4 Monitor Plug



### Application:

TAG's D4 Monitor Cord (PN# 400480MHS) is used to access dial tone from FXS and FXO cards. The D4 Monitor Cord directional switch enables dial tone to be pulled from the far end when plugged into the FXS card or near end (SMAS/Frame) when plugged into the FXO card.

### Ordering Information:

**400480MHS**

**D4 Monitor w/ Switch to 471A, (D4 Monitor Cord), (5')**

**AT&T PID #**  
**ATT.100090489**

150 Cooper Rd. (F-15)  
W. Berlin, NJ 08091

[www.tagcords.com](http://www.tagcords.com)  
**Telecom Assistance Group**

Telephone: (856) 753-8585  
Fax: (856) 768-7645

# D4 Channel Check Unit

# T-D4CC

**Need a CMC 5151 Channel Chek Unit ?**

***TAG has a  
Replacement Model for this  
previously discontinued part....***

**DISCONTINUED  
CMC 5151  
CHANNEL CHEK UNIT  
(YELLOW BOX)**



**PN # T-D4CC**  
D4 Channel Check Unit



### Application:

- With the switch in the idle "MONITOR" position, insert the # T-D4CC channel checker into the port on the face of the D4 card.
- Slide the switch to "DROP" & observe the led's for a green-red-green sequence indicating a "wink" from the local PBX equipment.

### Ordering Information:

**T-D4CC**

**D4 Channel Check Unit**

**AT&T PID #**

**ATT.100090490**

150 Cooper Rd. (F-15)  
W. Berlin, NJ 08091

[www.tagcords.com](http://www.tagcords.com)

Telephone: (856) 753-8585

Fax : (856) 768-7645

**Telecom Assistance Group**

**New Replacement Dumb Terminals - Transport / DACS Equipment**

**NEW TERMINAL WORKS ON**  
**Titan 5500, CS1, CS1L, DACS II, III, IV, Alcatel 1631 & HDSL**  
*(Titan 5500 shown below)*

**REMOVE & REPLACE  
 OLD / BROKEN CRTs**



**AT&T PID #**  
**ATT.100087610**

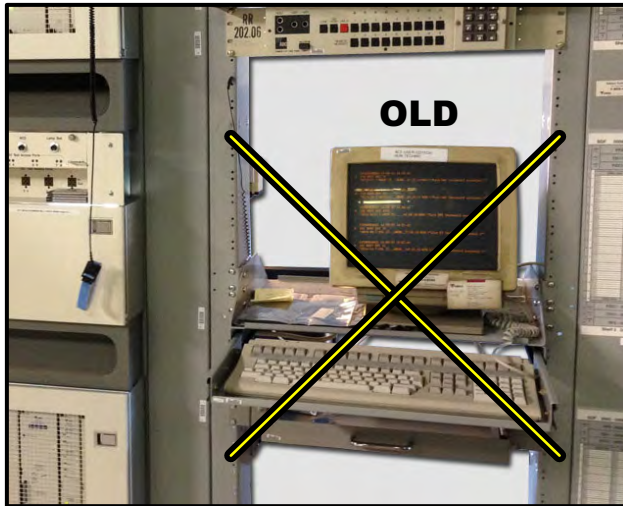

- SPECIFICATIONS**
- VT-100 COMPATIBLE
  - SINGLE RS-232 INPUT
  - PRINTER OUTPUT
  - LOW POWER

- New Terminal Includes:**
- (1) 17" Flat Screen Monitor
  - (1) Dumb Terminal Controller
  - (1) Keyboard
  - (1) Quick Guide
  - (1) 400701, (DB25M Gender Changer)

**Ordering Information:**

**TT-VT100S TAG Replacement Dumb Terminal - Transport / DACS**  
 includes: (1) 17" Flat Screen Monitor, (1) Keyboard, (1) DB25M Gender Changer,  
 (1) Single Session Dumb Terminal Controller & (1) Quick Guide

**AT&T PID #**  
**ATT.100087610**

**400705-XX\* DB25M to DB25M - Serial Cable, (XX') (optional - call for pricing)**  
*\* Please specify length of cable when ordering - Ex: 400706-25 = 25'*

150 Cooper Rd. (F-15)  
 W. Berlin, NJ 08091

[www.tagcords.com](http://www.tagcords.com)

Telephone: (856) 753-8585  
 Fax : (856) 768-7645

**Telecom Assistance Group**

# 5ESS MCC / ROP Terminal

**TAG offers a New Feature on our 5ESS MCC Dumb Terminal, The "Glass Printer" Feature**

## REMOVE & REPLACE OLD / BROKEN CRTs & PRINTERS

**OLD**



**NEW**

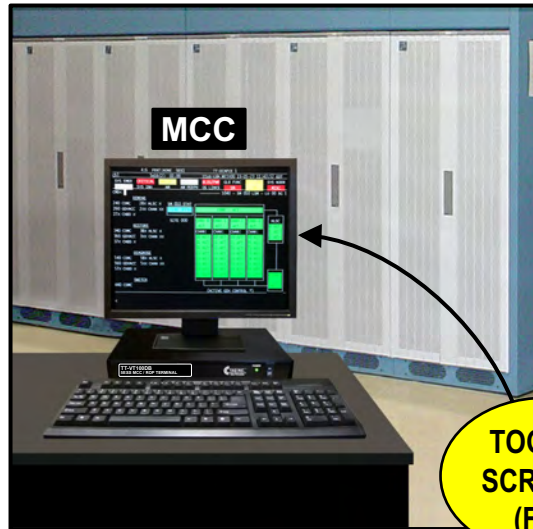

**TOGGLE SCREENS (F12)**



**ROP PRINTER**

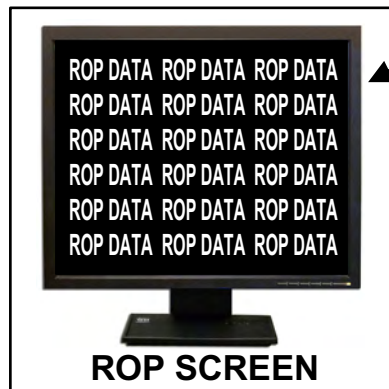

**ROP SCREEN**

*new label on the keyboard above the F12 key*



### SPECIFICATIONS

- VT-100 COMPATIBLE
- LOW POWER
- AUTO-BAUD

### **Ordering Information:**

**TT-VT100DB 5ESS MCC / ROP Terminal**

**AT&T PID #  
ATT.200006843**

includes: (1) 17" Flat Screen Monitor, (1) Keyboard,  
(1) MCC Terminal Controller w/ ROP Glass Printer & Auto Baud Feature,  
(2) # 400701, DB25M Gender Changers & (1) Quick Guide

150 Cooper Rd. (F-15)  
W. Berlin, NJ 08091

[www.tagcords.com](http://www.tagcords.com)

Telephone: (856) 753-8585  
Fax : (856) 768-7645

## Telecom Assistance Group

## DMS Terminal Replacements - Dual Session

### Model:

**TT-DCAP-DMSKIT**

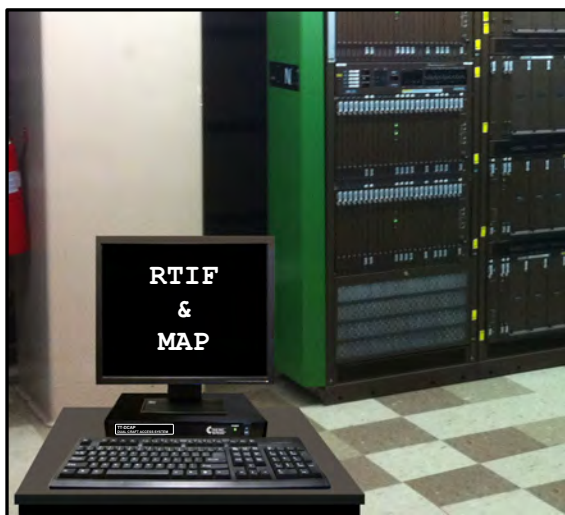

### Kit Includes (TT-DCAP-DMSKIT):

- (1) 17" Flat Screen Monitor
- (1) Dumb Terminal Controller
- (1) Keyboard
- (1) Quick Guide
- (2) 400700,  
(DB25F Gender Changer) 
- (2) 400725SB2,  
(DMS Quick Connect Current Loop Adapter Cable w/ DEC Connector)



### SPECIFICATIONS

- VT-100 COMPATIBLE
- DUAL RS-232 INPUTS
- PRINTER OUTPUT
- LOW POWER

### Printer Port Type:



Parallel \* *If a Serial Port is needed, please order a Parallel to Serial Adapter # TT-PSA, Call for Pricing.*

### Ordering Information:

#### TT-DCAP-DMSKIT

#### Dual Craft Access System - DMS Kit

includes: (1) 17" Flat Screen Monitor, (1) Keyboard,  
(1) Dual Session Dumb Terminal Controller, (1) Quick Guide,  
(2) # 400700 (DB25F Gender Changer) &  
(2) # 400725SB2 (DMS Quick Connect Current Loop Adapter Cable w/ DEC Connector)

**AT&T PID #**  
**ATT.200007660**

#### TT-DCAP-DMSKIT1

#### Dual Craft Access System - DMS (Kit 1)

includes: (1) 17" Flat Screen Monitor, (1) Keyboard,  
(1) Dual Session Dumb Terminal Controller, (1) Quick Guide,  
(2) # 400700 (DB25F Gender Changer) &  
(1) # 400725SB2 (DMS Quick Connect Current Loop Adapter Cable w/ DEC Connector)

**AT&T PID #**  
**ATT.200007657**

#### TT-DCAP-DMSKIT2

#### Dual Craft Access System - DMS (Kit 2)

includes: (1) 17" Flat Screen Monitor, (1) Keyboard,  
(1) Dual Session Dumb Terminal Controller, (1) Quick Guide,  
(2) # 400700 (DB25F Gender Changer),  
(2) # 400725SB2 (DMS Quick Connect Current Loop Adapter Cable w/ DEC Connector) &  
(2) # 400725SBW\*\* (Hardwire Adapter for 400725SB2) \*\*not shown

**AT&T PID #**  
**ATT.200007655**

#### TT-DCAP

#### Dual Craft Access System - DMS

includes: (1) 17" Flat Screen Monitor, (1) Keyboard,  
(1) Dual Session Dumb Terminal Controller, (1) Quick Guide &  
(2) # 400700 (DB25F Gender Changer)

**AT&T PID #**  
**ATT.200007659**

150 Cooper Rd. (F-15)  
W. Berlin, NJ 08091

[www.tagcords.com](http://www.tagcords.com)

Telephone: (856) 753-8585

Fax : (856) 768-7645

**Telecom Assistance Group**